

GREENWAY[®]

PRECISION CNC LATHE

HCS-25/32 & HCS-25B/32B

精密臥式數控車床(走心/走刀式&雙主軸)

Precision Horizontal CNC Lathe
(Sliding Head / Swiss / Fixed Head / Dual-Spindle Type)

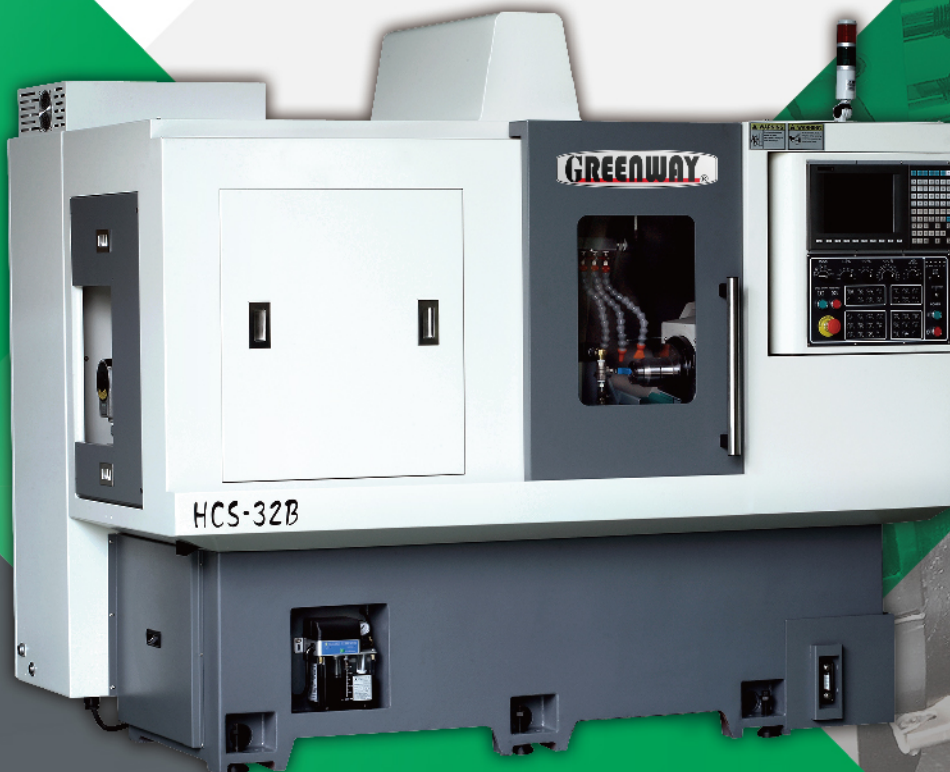

www.cnc-lathe.com
JARNG YEONG ENTERPRISE CO., LTD.

HCS-25/32

SLIDING HEAD / SWISS TYPE CNC LATHE

主軸移動/走心式數控車床

高剛性結構車體，可作走心/走刀兩用車床，具有車、銑、鑽孔、攻牙及輪廓等多樣化加工功能，適用於長工件加工，縮短加工製程，提高生產力。

High rigidity body, sliding head or fixed head type CNC lathe with turning, milling, drilling, tapping and contouring functions, also suitable for processing long workpiece which can shorten the process and enhance the productivity.

產品說明 / DESCRIPTION

- ▶ 高剛性結構車體，一體成型底座，高剛性線軌，提供更穩定、更快速、更精確的加工進給。
High rigidity body structure, machine base casting is integrally formed and high rigidity linear guideway, providing stabler, faster and higher precision.
- ▶ 具有車、銑、鑽孔、攻牙、輪廓等多樣化加工功能，適用於長工件加工，可減少加工時間，提高生產效率。
With turning, milling, drilling, tapping and contouring functions, also suitable for processing long workpiece which can reduce cycle processing time and improve production efficiency.
- ▶ 具有加工品質高精度、低噪音、低振動等特性。
High precision processing quality, low noiseless and low vibration.
- ▶ 最多可使用18位刀具，搭配同步迴轉導套，能加工長工件。
Max.18 tools and works with synchronous rotary guide bushing device to process long workpiece.



- ▶ 主軸採用內藏式主軸，具有C軸功能，擁有高轉速、大功率、高精度、低震動等特性，能使加工表面更為細緻平滑。
Built-in spindle is with C-axis function, high speed, big power, high precision and low vibration which can make surface of workpiece smoother.
- ▶ 油壓迴轉缸提供快速穩定的夾持力。
Rotary hydraulic cylinder provides fast and stable clamping force.
- ▶ 走心式 / 走刀式兩用車床，可依據不同的加工需求，選擇更換走心式 / 走刀式組合結構。
It can depend on different demand of machining to with or without synchronous rotary guide bushing device.
- ▶ 走心式行程180 mm，最少殘料150 mm；走刀式行程310 mm，最少殘料50 mm。
With guide bush type travel is 180 mm, min. offal is 150 mm. Without guide bush type travel is 310 mm, min. offal is 50 mm.

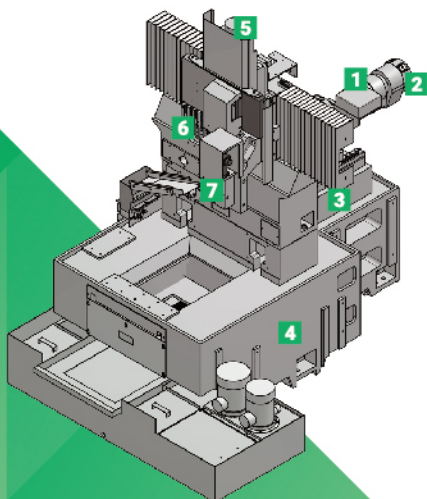

3D模型圖 / 3D MODEL

- 1 內藏式主軸最高轉速6000 rpm，具有C軸功能。
Built-in spindle includes C-axis function, max. 6000 rpm.
- 2 油壓迴轉缸提供速度、穩定的夾持力。
Hydraulic cylinder provides high speed and stable clamping.
- 3 高剛性線軌，提供穩定、快速和精確的加工進給。
High rigidity linear guideway provide stable, rapid and precise feed.
- 4 一體成型底座，高剛性、高穩定性。
Machine body made from one piece solid cast iron, high rigidity and stability.
- 5 X,Y,Z軸快速移動達 25米/分。
X,Y,Z-axis rapid travel speed are max. 25 m/min.
- 6 6位置外徑車刀架口16
- 7 端面3軸動力裝置(ER-20)(選配)。
End face live tool device(3-shaft, ER-20)(opt)



HCS-25/32

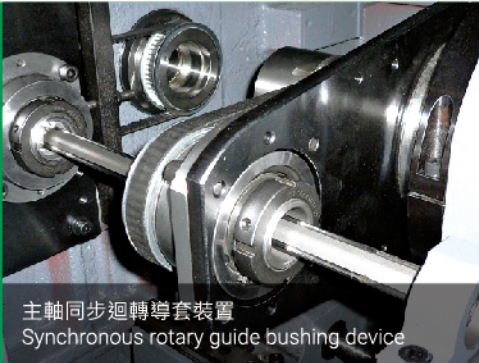

主軸同步迴轉導套裝置
Synchronous rotary guide bushing device

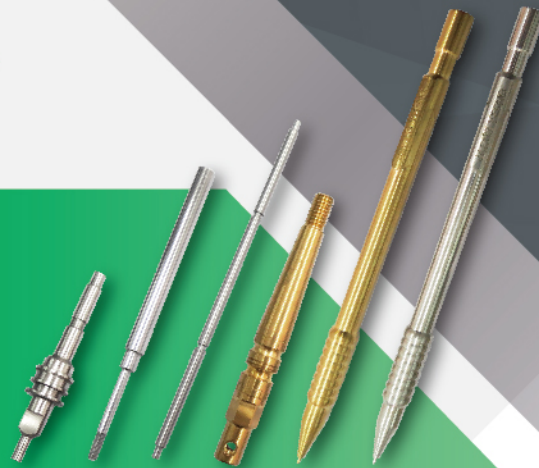

▲ HCS-25/32-走心式車削樣品參考
Swiss type turning sample reference



◀ 主軸內孔襯套組(PE材質)(4只/組)
Spindle inner-hole bush
(PE material, 4 pcs/set)

▶ 長工件取料盒(選配)
(需搭配輔助尾座及電動鏈板式排屑)
Long workpiece parts collecting box(opt)
(must work with auxiliary tailstock and
electrical steel belt type chip conveyor)



HCS-25/32 標準配件與選購配件

Standard Accessories and Optional Accessories for HCS-25/32

標準配件 Standard Accessories

工具及工具箱 Tools and tools box	1 SET	LED工作燈 Lighting device	1 SET	自動潤滑系統 Auto lubrication system	1 SET
6位置車刀架(口16) 6 position tool holder(□16)	1 SET	主軸筒夾 Spindle collet	1 PC	鎢鋼導套 Guide bush	1 PC
同步迴轉導套裝置 Synchronous rotary guide bushing device	1 SET	成品取料裝置及輸送帶 Parts catcher with conveyor	1 SET	機械墊塊 Base leveling block	4 PCS
主軸油冷卻裝置 Spindle oil cooling device	1 SET	內藏式主軸 Built-in spindle	1 SET	密閉式空調冷卻機(用於電器箱) Air-Condition unit for electric box	1 SET
變壓器 Transformer	1 SET	C軸功能含鎖定 C-axis function with lock	1 SET	端面5位置鉗孔座(I.D.Ø20) 5 position end face drilling device	1 SET
切削水設備含1HP強力冷卻幫浦 Cutting coolant system with 1HP powerful coolant pump	1 SET	側銑4軸動力裝置(ER-16) Side face milling device-4 shaft live tool(ER-16)	1 SET	無料異警警示燈 No-material alarm indicating lamp	1 SET
內孔套筒(I.D.Ø6, 8, 10, 12, 16 / O.D.Ø20) 各1只 Tool holder bush(I.D.Ø6, 8, 10, 12, 16 / O.D.Ø20) per pc	1 SET				

選購配件 Optional Accessories

長工件取料盒 Long workpiece parts collecting box	電動鏈板式鐵屑排出機 Electrical steel belt type chip conveyor	穩壓器 Voltage stabilizer	輔助尾座 Auxiliary tailstock
棒材自動送料機 Hydrodynamic auto bar feeder	主軸內孔襯套組(PE材質) Spindle inner-hole bush(PE material)	油霧回收機 Oil mist collector	油水分離機 Oil skimmer
端面3軸動力裝置(ER-20) End face live tool device(3-shaft, ER-20)	主軸導套(走刀式固定座) Spindle guide bush(Fixed head type spindle block)		CE規格 CE specification

HCS-25B/32B

DUAL-SPINDLE CNC LATHE 雙主軸數控車床

雙主軸車床，正面、背面同時加工，提高作業效率，亦可選配同步迴轉導套裝置，加工長軸型工件，可彈性靈活運用。

Dual-spindle can process both sides of the workpiece synchronously to enhance the productivity. Synchronous rotary guide bushing device can be optional for processing long shaft piece to reach various needs.

產品說明 / DESCRIPTION

- ▶ 高剛性結構車體，一體成型底座，高剛性線軌，提供更穩定、更快速、更精確的加工進給。
High rigidity body structure, machine base casting is integrally formed and high rigidity linear guideway, providing stabler, faster and higher precision.
- ▶ 具有車、銑、鑽孔、攻牙、輪廓等多樣化加工功能，可減少加工時間，提高生產效率。
With turning, milling, drilling, tapping and contouring functions, it can reduce cycle processing time and improve production efficiency.
- ▶ 正主軸採用內藏式主軸，具有C軸功能，擁有高轉速、大功率、高精度、低震動等特性，能使加工表面更為細緻平滑。
Built-in main spindle is with C-axis function, high speed, big power, high precision and low vibration which can make surface of workpiece smoother.
- ▶ 副主軸具有C軸功能，由伺服馬達驅動，搭配動力刀具裝置可作背面銑削。
Sub-spindle is with C-axis function, it can work live tool device for back side drilling, tapping and milling.

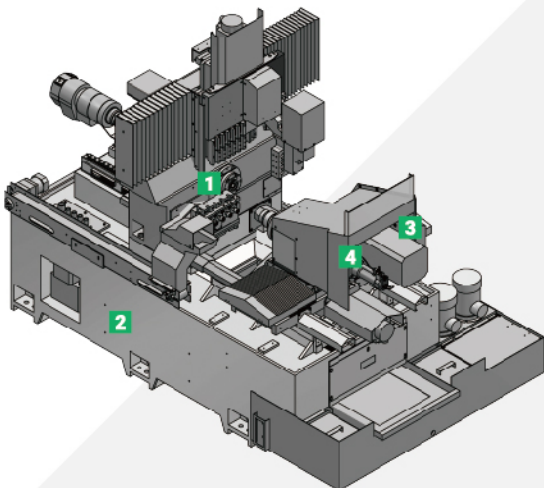

- ▶ 最多可使用23位刀具，能同時進行正面、背面加工，可節省加工時間。
Max. 23 tools, can do machining on front side and back side at the same time which can save time for processing.
- ▶ 油壓迴轉缸提供快速穩定的夾持力，搭配同步迴轉導套，能加工長軸型物件。
Rotary hydraulic cylinder provides fast and stable clamping force, also can be optional with synchronous rotary guide bushing device to process long shaft pieces.
- ▶ 走心式 / 走刀式兩用車床，可依據不同的加工需求，選擇更換走心式 / 走刀式組合結構。
It can depend on different demand of machining to with or without synchronous rotary guide bushing device.
- ▶ 走心式行程180 mm，最少殘料150 mm；走刀式行程310 mm，最少殘料50 mm。
With guide bush type travel is 180 mm, min. offal is 150mm. Without guide bush type travel is 310 mm, min. offal is 50 mm.

3D模型圖 / 3D MODEL

- 1 副主軸端面動力裝置由伺服馬達驅動，可做背面加工。
End face live tool device for sub-spindle is driven by servo motor to do back side processing.
- 2 一體成型底座，高剛性、高穩定性。
Machine body made from one piece solid cast iron, high rigidity and stability.
- 3 副主軸具C軸功能，可獨立加工，最高轉速為6,000轉。
Sub-spindle with C-axis function allows to process individually. Max. rotating speed is 6,000 rpm.
- 4 副主軸吹氣及推料裝置。
Air-blowing and finished parts ejector device for Sub-spindle.

HCS-25B/32B

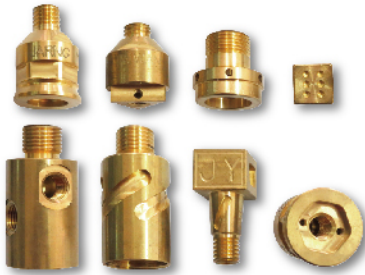

▲ HCS-25B/32B - 雙主軸車削樣品參考
Dual-spindle turning sample reference

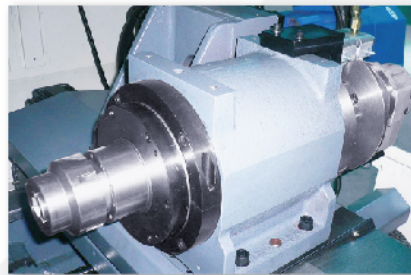

▲ 副主軸C軸功能含碟煞裝置(選配)
C-axis function with disk brake device for Sub-spindle(opt)

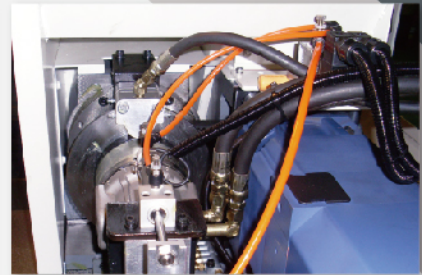

▲ 副主軸吹氣及推料裝置
Air-blowing and finished parts ejector device for Sub-spindle

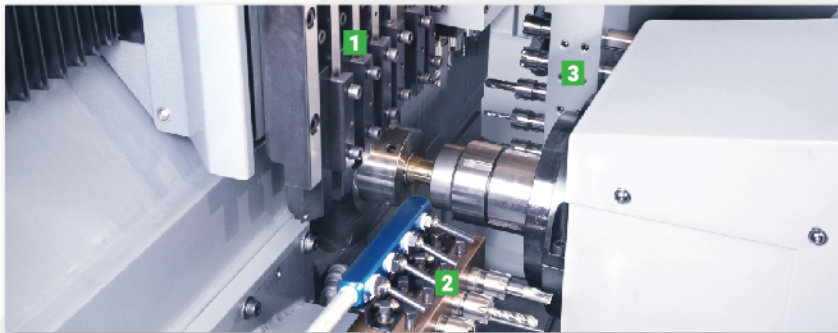

- ◀ 1 6位置車刀架口16
6 position tool holder □16
- 2 副主軸動力裝置(ER-16)(選配)
End face live tool device for Sub-spindle(ER-16)(opt)
- 3 端面5位置鉗孔座(I.D.Ø20)
5 position end face drilling device (I.D.Ø20)

HCS-25B/32B 標準配件與選購配件

Standard Accessories and Optional Accessories for HCS-25/32B

標準配件 Standard Accessories

工具及工具箱 Tools and tools box	1 SET	LED工作燈 Lighting device	2 SETS	自動潤滑系統 Auto lubrication system	1 SET	變壓器 Transformer	1 SET
6位置車刀架(□16) 6 position tool holder(□16)	1 SET	筒夾(正/副主軸) Collet(Main/Sub-spindle)	2 PCS	機械墊塊 Base leveling block		6 PCS	
主軸固定座 Fixed head type spindle block	1 SET	成品取料裝置及輸送帶 Parts catcher with conveyor	1 SET	密閉式空調冷卻機(用於電器箱) Air-Condition unit for electric box		1 SET	
正主軸油冷卻裝置 Main spindle oil cooling device	1 SET	內藏式正主軸 Built-in main spindle	1 SET	端面5位置鉗孔座(I.D.Ø20) 5 position end face drilling device		1 SET	
C軸功能含鎖定 C-axis function with lock	1 SET	副主軸C軸功能 C-axis function for Sub-spindle	1 SET	側銑4軸動力裝置(ER-16) Side face milling device-4 shaft live tool		1 SET	
副主軸吹氣及推料裝置 Air-blowing and finished parts ejector device for Sub-spindle	1 SET	副主軸端面4位置鉗孔裝置(I.D.Ø20) 4 position drilling device for Sub-spindle(I.D.Ø20)	1 SET	內孔套筒(I.D.Ø6,8,10,12,16 / O.D.Ø20) 各1只 Tool holder bush(I.D.Ø6,8,10,12,16 / O.D.Ø20) per pc		1 SET	
切削水設備含1HP強力冷卻幫浦 Cutting coolant system with 1HP powerful coolant pump	1 SET						

選購配件 Optional Accessories

穩壓器 Voltage stabilizer	電動鏈板式鐵屑排出機 Electrical steel belt type chip conveyor	同步迴轉導套裝置 Synchronous rotary guide bushing device
油霧回收機 Oil mist collector	油水分離機 Oil skimmer	副主軸碟煞裝置 Disk brake device for Sub-spindle
主軸內孔襯套組(PE材質) Spindle inner-hole bush(PE material)		CE規格 CE specification
正主軸端面3軸動力裝置(ER-20) End face live tool device for main spindle(3-shaft, ER-20)		油壓檢知 Hydraulic cylinder detection device
副主軸端面4位置鉗孔裝置(IDØ20)更換為4軸動力裝置(ER-16) Change 4 position end face drilling device (I.D.Ø20) for Sub-spindle to live tool device (4-shaft, ER-16)		棒材自動送料機 Hydrodynamic auto bar feeder

機械規格 / MACHINE SPECIFICATION

機型 MODEL		單位	HCS-25	HCS-32	HCS-25B	HCS-32B
正主軸 Main spindle						
最大加工外徑	Max. turning dia.	mm	25	32	25	32
主軸內藏式馬達	Spindle with built-in motor	KW	3.75 / 5.5(opt)	3.75 / 5.5(opt)	3.75 / 5.5(opt)	3.75 / 5.5(opt)
主軸迴轉速	Spindle rotating speed	rpm	6,000	6,000	6,000	6,000
主軸貫穿孔徑	Bore of spindle	mm	Ø28	Ø33	Ø28	Ø33
棒材容納直徑	Max. bar feeding dia	mm	Ø25	Ø32	Ø25	Ø32
X軸移動量	X-axis travel	mm	150	150	150	150
Y軸移動量	Y-axis travel	mm	420	420	420	420
Z軸移動量	Z-axis travel	mm	310無導套/180有導套 310-without guide bush 180-with guide bush	310無導套/180有導套 310-without guide bush 180-with guide bush	310無導套/180有導套 310-without guide bush 180-with guide bush	310無導套/180有導套 310-without guide bush 180-with guide bush
X/Y/Z軸快速移動	X/Y/Z-axis rapid travel speed	m/min	25	25	25	25
X/Y/Z軸伺服馬達	X/Y/Z-axis servo motor	KW	1	1	1	1
筒夾規格	Collet type	-	星辰Citizen 25#	164E or 1536E	星辰Citizen 25#	164E or 1536E
導套規格	Guide bush type	-	星辰Citizen 25#	星辰Citizen 32# or Star 32#	星辰Citizen 25#(opt)	星辰Citizen 32#(opt) or Star 32#(opt)
外徑刀具數	No. of O.D. turning tools	pcs	6	6	6	6
內徑刀具數	No. of I.D. turning tools	pcs	5	5	5	5
外徑刀尺寸	O.D. turning tool size	mm	□16	□16	□16	□16
內徑刀尺寸	I.D. turning tool size	mm	Ø20	Ø20	Ø20	Ø20
軌道型式	Guideway type	-	線軌 Linear guideway	線軌 Linear guideway	線軌 Linear guideway	線軌 Linear guideway
切削液幫浦	Cutting coolant pump	HP	1	1	1	1
切削液容量	Cutting coolant volume	L	120	120	150	150
自動潤滑系統	Auto lubrication system	c.c/min	3~6 c.c/15 min	3~6 c.c/15 min	3~6 c.c/15 min	3~6 c.c/15 min
副主軸 Sub-spindle						
最大加工外徑	Max. turning dia.	mm	-	-	25	32
副主軸馬達	Sub-spindle motor	KW	-	-	2.2 / 3.75(opt)	2.2 / 3.75(opt)
副主軸迴轉速	Sub-spindle rotating speed	rpm	-	-	6,000	6,000
X軸移動量	X-axis travel	mm	-	-	305	305
Z軸移動量	Z-axis travel	mm	-	-	240	240
X/Z軸快速移動	X/Z-axis rapid travel speed	m/min	-	-	25	25
X/Z軸伺服馬達	X/Z-axis servo motor	KW	-	-	1	1
筒夾規格	Collet type	-	-	-	星辰Citizen 25#	164E or 1536E
外徑刀具數	No. of O.D. turning tools	pcs	-	-	1	1
內徑刀具數	No. of I.D. turning tools	pcs	-	-	4	4
外徑刀尺寸	O.D. turning tool size	mm	-	-	□16	□16
內徑刀尺寸	I.D. turning tool size	mm	-	-	Ø20	Ø20
切削液幫浦	Cutting coolant pump	HP	-	-	1	1
正主軸動力刀具 Main spindle live tooling						
側銑動力刀具 伺服馬達	Servo motor of side live tooling	KW	2	2	2	2
側銑動力刀具 最高轉速	Max. rotating speed of side live tooling	rpm	5,000	5,000	5,000	5,000
側銑動力刀具 刀具數	No. of side live tooling	pcs	4	4	4	4
側銑動力刀具 刀具規格	Side live tooling specification	-	ER-16	ER-16	ER-16	ER-16
端銑動力刀具 伺服馬達	Servo motor of end live tooling	KW	2(opt)	2(opt)	2(opt)	2(opt)
端銑動力刀具 最高轉速	Max. rotating speed of end live tooling	rpm	5,000(opt)	5,000(opt)	5,000(opt)	5,000(opt)
端銑動力刀具 刀具數	No. of end live tooling	pcs	3(opt)	3(opt)	3(opt)	3(opt)
端銑動力刀具 刀具規格	End live tooling specification	-	ER-20(opt)	ER-20(opt)	ER-20(opt)	ER-20(opt)
副主軸動力刀具 Sub-spindle live tooling						
端銑動力刀具 伺服馬達	Servo motor of end live tooling	KW	-	-	2(opt)	2(opt)
端銑動力刀具 最高轉速	Max. rotating speed of end live tooling	rpm	-	-	5,000(opt)	5,000(opt)
端銑動力刀具 刀具數	No. of end live tooling	pcs	-	-	4(opt)	4(opt)
端銑動力刀具 刀具規格	End live tooling specification	-	-	-	ER-16(opt)	ER-16(opt)
機台規格 Machine specification						
機器尺寸(大約值)	Approx. machine size	mm (LxWxH)	2100 x 1580 x 2000	2100 x 1580 x 2000	2700 x 1600 x 2000	2700 x 1600 x 2000
機器淨重(大約值)	Approx. net weight	KGS	2400	2400	3000	3000

本公司產品規格/設計/特性，均不斷研究改進，如有變更，不再另行通知。

All specifications, dimensions and design characteristics shown in this catalogue are subject to change without notice.

Version 2018.11



昌勇實業股份有限公司

JARNG YEONG ENTERPRISE CO., LTD.

43346 台中市沙鹿區清泉路1-9號

No. 1-9, Ching Chien Rd., Ching Chien Village, Shalu District, Taichung City 43346, Taiwan

Tel +886-4-2615-2157

Fax +886-4-2615-2161

Web www.cnc-lathe.com

E-mail greenway@cnc-lathe.com

代理商 / AGENT