

FULSON®

福順磨床 · 無與倫比

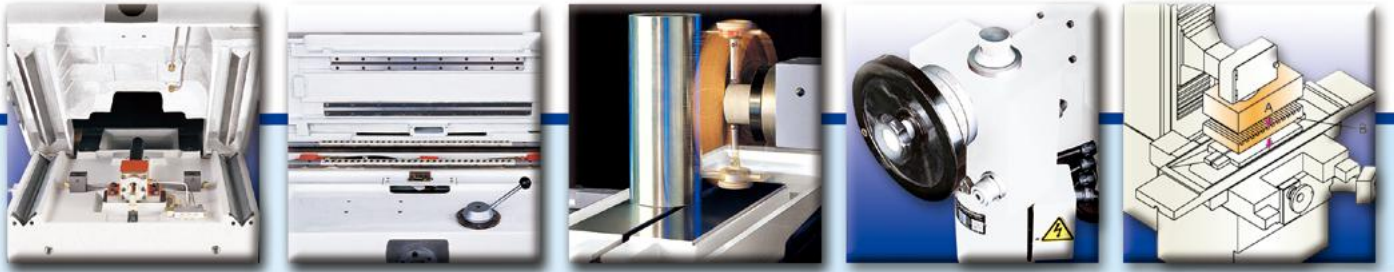

FSG · SP Series

High Precision Surface Grinder

612SP · 618SP · 818SP

FSG-618M · 2A618

FSG-2A818 · 3A818

FSG-2A1224 · 3A1224

ACCUGRIND-612 · 618 · 818 SP Series

Super Precision Surface and Form Grinder

Machine Features

- Table traverses on linear ball bearings and D2 (SKD11) hardened and ground guideways.
- Reinforced ribbed column with hardened and ground guideway system.
- Elevating and crossfeed leadscrews are hardened and ground.
- Saddle travels on Turcite-B coated and hand-scraped double-V guideways.
- Vertical handwheel at waist level.
- 0.001 mm (0.00005") vertical micro-feed device.
- Permanently lubricated and sealed cartridge-type spindle uses two pairs of Class 7 (P4) angular contact ball bearings.
- 2 HP dynamically balanced spindle motor.
- Automatic lubrication system.
- Main structure made of high quality cast iron.
- A mirror surface can be accomplished on these machines accurately and efficiently due to machine construction features and the specially designed V3 grade spindle motor that provide excellent rigidity and stability.

Table Guideways

Table is driven by steel wire and traverses on hardened and ground guideways with steel ball bearings which have been accurately sieved. This provides smooth, accurate, and efficient table movement.

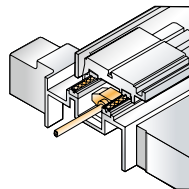

Automatic Lubrication

The lubrication system provides lube oil to saddle, column ways, crossfeed and elevating leadscrews. This system minimizes the wear due to negligent operation, ensuring the machine accuracy and extending the life of machine. (3 cc / 30 min).

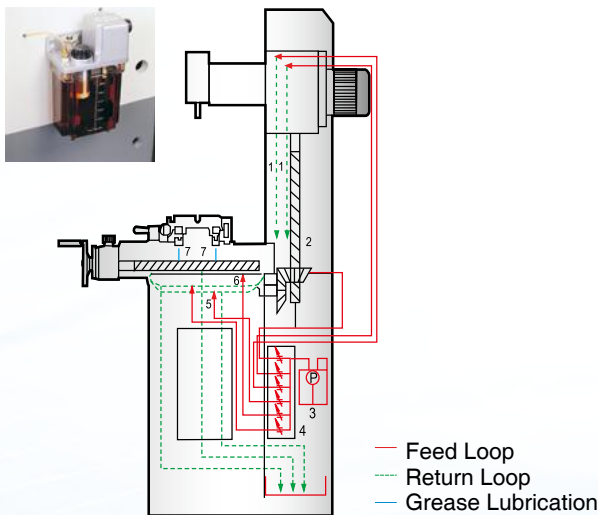

1. Column slideways
2. Elevating leadscrew
3. Lubricator
4. Oil distributor
5. Machine base double-V slideways
6. Crossfeed leadscrew
7. Table guideways with ball bearings are lubricated by grease.

Durable Slideways

Machine-base slideways are laminated with Turcite-B and precisely hand-scraped, low-friction slideways incorporated with an automatic intermittent lubrication system to ensure high accuracy and longer life of slideways.

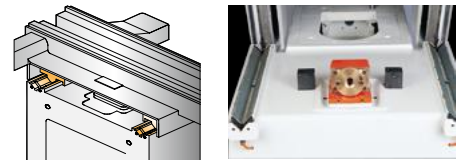

ACCUGRIND-818SP

Note: Machine shown with optional accessories

ACCUGRIND-612 · 618 · 818 SP Series

Super Precision Surface and Form Grinder

Permissible Load of Machine

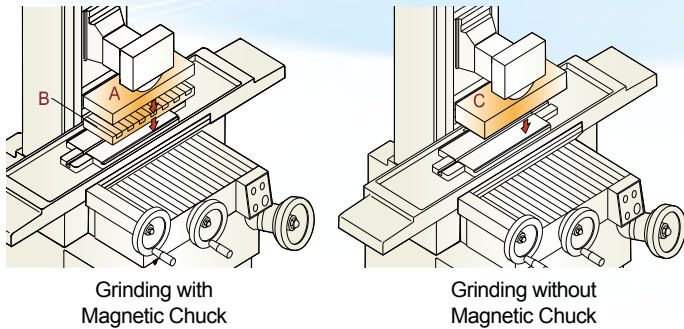

The total suggested maximum workloads of table are shown as follows:

Model	kg (lb)		
	612SP	618SP	818SP
A	130 (286)	180 (396)	215 (474)
B	20 (44)	30 (66)	35 (77)
C	150 (330)	210 (462)	250 (551)

High Precision Cartridge Type Spindle

Spindle is supported by four pieces of Class 7 (P4) super-precision angular-contact ball bearing. The bearings are accurately measured, selected and preloaded and assembled to ensure superior water resistance, longevity grinding accuracy and surface finish. The labyrinth seal type structure is designed to offer better water-resistance enhancing longevity of the spindle bearings.

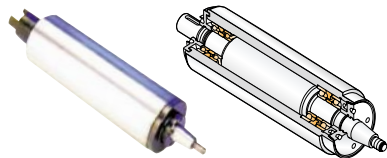

Indexing Table Handwheel

The table handwheel can be indexed to a comfortable position to enhance the ease of table traverse.

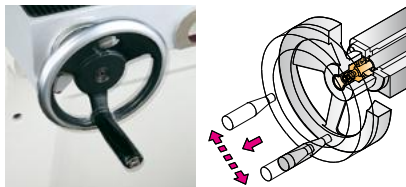

Wheelhead and Column

The column casting is cross-ribbed for extra rigidity. The elevating guideways of wheelhead and column are hardened and ground. The sliding surfaces of the wheelhead are laminated with Turcite-B, providing accuracy of downfeed and machine longevity.

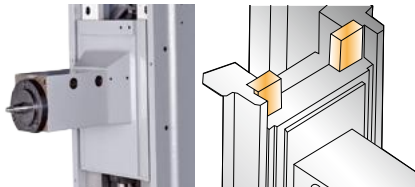

Elevating Micro-Feed Device

The micro-feed device utilizes a worm and worm gear for vertical feeds in increments of 1 μm (0.00005"). The micro-feed device is engaged by turning the lever clockwise, which also locks the handwheel to prevent any danger caused by accidentally touching the handwheel. Operation of the handwheel can be resumed by turning the lever counter-clockwise.

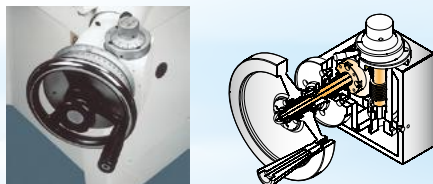

Typical Accuracy

Parallelism of upper and lower sides of the workpiece within 0.002 mm (0.0001") Conditions:

- Material: SAE1045 (S45C), HRC45
- Workpiece size: Ø25.4 x 25.4 mm (1" x 1")
- Grinding wheel: 38A46H (or equivalent)
- Dressing speed: 60~360 mm/min (0.04~0.24 inch/sec)
- Specification of dressing diamond: 0.5~1.0 carat
- Dressing depth: 0.003~0.006 mm (0.0001"~0.0002")
- Table speed: 10~20 m/min (33~66 fpm)
- Grinding depth per stroke: 0.001~0.005 mm (0.00005"~0.0002")
- Room temperature: 20~25 °C (68~77 °F)
- Grinding wheel size: Ø203 x 12.7 x Ø31.75 mm (Ø8" x 0.5" x Ø1 1/4")



Surface finish better than (or equal to) Rmax 0.3S (3 micro inch AA) Conditions:

- Material: D2 (SKD11), HRC60
- Workpiece size: 100 x 100 mm (3.93" x 3.93")
- Grinding wheel: ELBE 89A60-2111V26 (or equivalent)
- Dressing speed: 60~360 mm/min (0.04~0.24 inch/sec)
- Specification of dressing diamond: 0.5~1.0 carat
- Dressing depth: 0.01 mm (0.0004")
- Table speed: 10~20 m/min (33~65 fpm)
- Grinding depth per stroke: 0.001 mm (0.00005")
- Crossfeed: 0.4 mm (0.016")
- Room temperature: 20~25 °C (68~77 °F)
- Grinding wheel size: Ø203 x 12.7 x Ø31.75 mm (Ø8" x 0.5" x Ø1 1/4")



FSG-618M · 2A618 Series

High Precision Surface Grinder

Machine Features

- This high-precision surface grinder has been specially developed to help manufactures with a wide range of needs.
- The tool cabinet in the machine base is specially designed for operator's convenience (618M).
- The interlock between electrical cabinet door and power supply is established to ensure safe operation.
- The maximum distance from the table surface to the spindle centerline is 450 mm (17.7"), which provides more clearance for grinding.
- The manual grinders feature a spring-loaded-type table travel-stops that dampen the over travel caused by abnormal operations.
- The optimum span of double-V crossfeed guideways is designed based on bending moment, kinematics and supporting force.
- All essential castings are high-grade cast iron which the stress-relieved has been done through annealing to eliminate internal stress.
- With the impressive stiffness and stability of its castings, this machine is suitable for both precision surface grinding and form grinding.
- This grinder is offered with one-year warranty for mechanical and electrical parts.

High Precision Cartridge Type Spindle

The spindle is supported by four pieces of Class 7 (P4) super-precision angular contact ball bearings, which have been accurately measured, selected and pre-loaded. Then it's assembled in a temperature controlled room to ensure better grinding accuracy and surface finish. The labyrinth seal type structure is designed to offer better water resistance, enhancing the longevity of the spindle bearings.



Indexable-Table Handwheel

The table handwheel can be indexed to a comfortable position to enhance the ease of table traverse. (618M only)

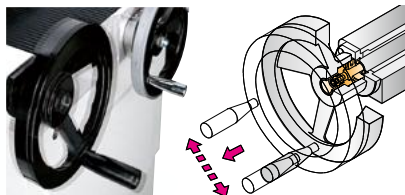

Continuous-Loop-Type Table Transmission Mechanism

A continuous-loop wire reinforced-cog timing belt drives the table. This system ensures slip-free and smooth transmission of table, enabling at least three-times longer life of a continuous-cog timing belt compared to that of the wire type or reciprocating timing belt type. The table traverses on hardened and ground guideways with steel ball bearings providing smooth, accurate and efficient table movement (618M).

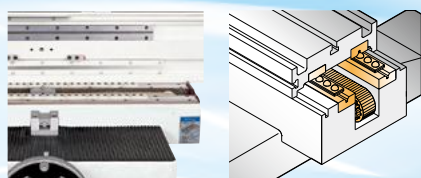

Durable Slideways

Machine base slideways are laminated with Turcite-B and precisely hand scraped. The low-friction slideways incorporated with automatic forced lubrication system ensures high-accuracy and longer way life.

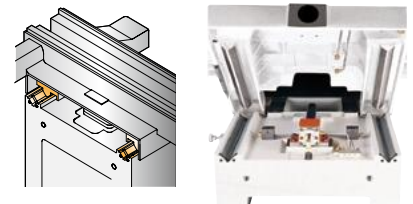

FSG-618M

Note: Machine shown with optional accessories

FSG-618M · 2A618 Series

High Precision Surface Grinder

Permissible Load of Machine

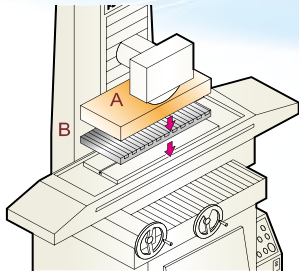

Grinding with Magnetic Chuck

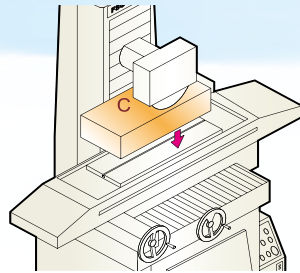

Grinding without Magnetic Chuck

The total suggested maximum workloads of table are shown as follows:

Model	FSG-618	FSG-2A618
A	180 (396)	
B	30 (66)	
C	210 (462)	

kg (lb)

Automatic Lubrication

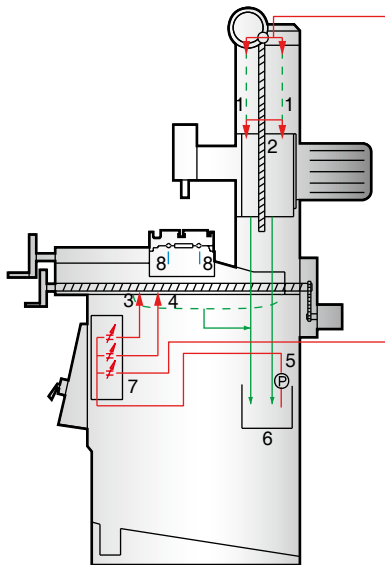

- 1. Column slideways
- 2. Elevating leadscrew
- 3. Crossfeed leadscrew
- 4. Machine base double-V slideways
- 5. Solenoid pump
- 6. Lubricator
- 7. Flow divider
- 8. Table guideways with ball bearings lubricated by grease

— Feed Loop
— Return Loop
— Grease Lubrication

Table Guide Ways (2A618)

By electronic non-contact reverser, operator can easily set suitable table stroke for each workpiece to save grinding time and obtain higher grinding efficiency, which have been accurately sieved, for smooth, accurate and efficient table movement. (2A618)

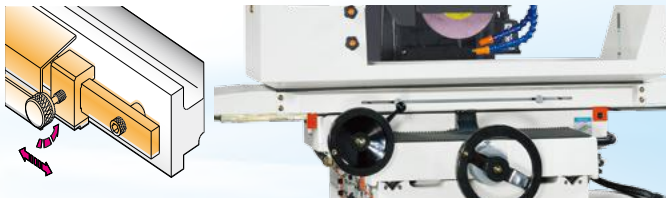
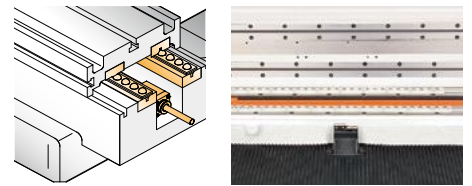

Table-Reversing Mechanism (2A618)

By using proximity switches, operator can easily set a suitable table stroke for each workpiece to save grinding time and to obtain higher grinding efficiency. The proximity switches have been properly covered for operator's safety (2A618).



FSG-2A618

Note: Machine shown with optional accessories

FSG-2A818 · 3A818 Series

Automatic Surface Grinder

Machine Features

This series has been specially developed and recently improved to continuously offer reliable high-performance precision surface grinders. The high-precision FSG-3A series surface grinder has recently improved the control panel with easy to read LED numerals. Chevalier offers a one year limited-warranty that includes parts for mechanical and electrical components.

The Double-V crossfeed guideway span has been designed by applying kinematics to calibrate for minimum bending moments, thus achieving maximum support capability for table and workpiece.

All essential castings are made of a high-grade cast iron that is stress relieved by annealing, ensuring the greatest stability and rigidity with low-stress.

An interlock is placed between the electrical cabinet door and the power supply as an added safety feature. The maximum distance from table surface to spindle centerline is 450 mm (17.7"), which provides more clearance for grinding.

High Precision Cartridge Type Spindle

The spindle is supported by four pieces of Class 7 (P4) super-precision angular contact ball bearings. The bearing are accurately measured, selected and preloaded, then assembled to offer superior water resistance, increasing the life of the spindle bearings in the temperature-controlled rooms. This ensures better grinding accuracy and surface finish. The labyrinth seal type structure is designed to offer superior water resistance, increasing the life of the spindle bearings.

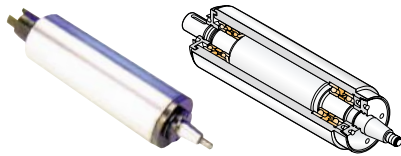

Table Reversing Mechanism

By using proximity switches, the operator can easily set a suitable table stroke for each workpiece to save grinding time and obtain higher grinding efficiency. The proximity switches have been properly covered for the safety of operator.

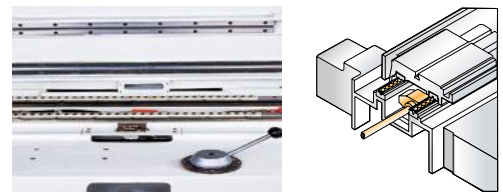

Table Guideways

By electronic non-contact reverser, operator can easily set suitable table stroke for each workpiece to save grinding time and obtain higher grinding efficiency, providing smooth, accurate and efficient table movement.



FSG-2A818

Note: Machine shown with optional accessories Longitudinal table movement is driven by hydraulic unit. Cross movement is driven by AC motor.

FSG-2A818 · 3A818 Series

Automatic Surface Grinder

Permissible Load of Machine

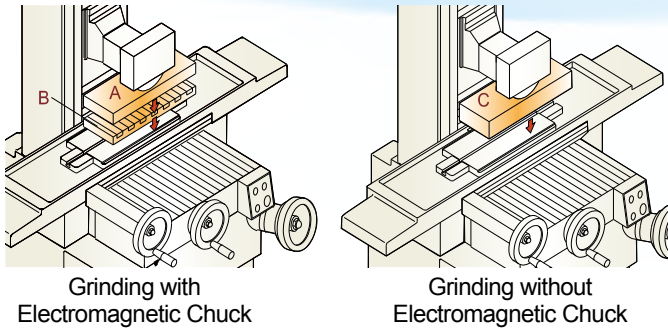

The total suggested maximum workloads of table are shown as follows:

MODEL	FSG-2A818	FSG-3A818
A	215 (474)	
B	35 (77)	
C	250 (551)	

kg (lb)

Durable Slideways

Machine-base slideways are laminated with Turcite-B and precisely hand-scraped, low-friction slideways incorporated with an automatic intermittent lubrication system to ensure high accuracy and longer life of slideways.

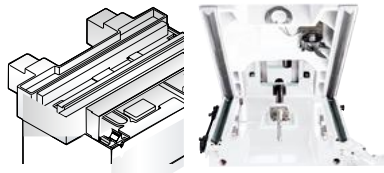

Elevating Micro-Feed Device (FSG-3A818)

The elevating system is equipped with a precision 0.002 mm (0.0001") graduated micro-feed device, consisting of a worm and worm gear for precise manual positioning of the Y-axis.

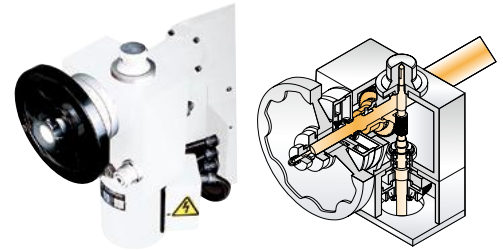

Control Station (FSG-3A818)

The control station can be easily adjusted to a comfortable position for the operator's convenience. All switches, indicators, lamps, LEDs, and displays are ergonomically designed for easy operation.

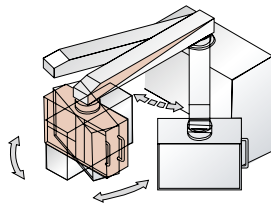

FSG-3A818

Note: Machine shown with optional accessories
 Longitudinal table movement is driven by hydraulic unit.
 Cross movement is driven by AC motor. Vertical feed is driven by AC motor and equipped with automatic downfeed device and manual micro downfeed device.

FSG-2A1224 · 3A1224 Series

Automatic Surface Grinder

Machine Features

This series has been specially developed and improved in recent years in order to continuously offer you reliable high performance precision surface grinders. And as a guarantee of that reliability we offer one year limited-warranty including parts for mechanical and electrical components. The Double-V crossfeed guideway span has been designed applying kinematics to calibrate minimum bending movements to achieve maximum support capability for table and workpiece.

All of high-grade cast iron that is stress-relieved by annealing to ensure superior stability and rigidity. An interlock has been placed between the electrical cabinet door and power supply as an added safety feature. The maximum distance from table surface to spindle centerline is 630 mm (24.8") which provides more space for grinding.

Longitudinal Slideways

The longitudinal slideways are laminated with Turcite-B and precisely hand scraped. The low-friction slideways incorporated with automatic forced lubrication system ensures high accuracy and longer way life.

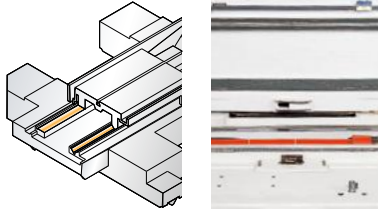

Durable Slideways (FSG-3A series)

Machine base slideways are laminated with Turcite-B and precisely hand-scraped. The low-friction slideways incorporated with automatic forced lubrication system ensures high accuracy and longer life of slideways.

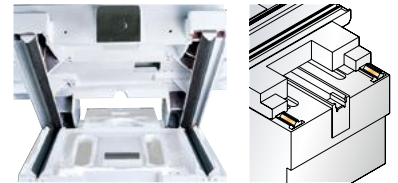

High-Precision-Type Spindle

The spindle is supported by four pieces of Class 7 (P4) super-precision angular-contact ball bearing. The bearings have been accurately measured, selected and preloaded and then assembled to ensure superior water resistance, longevity grinding accuracy and surface finish. The labyrinth seal type structure is designed to offer superior water resistance, increasing the life of the spindle bearings.

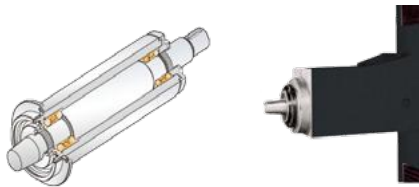
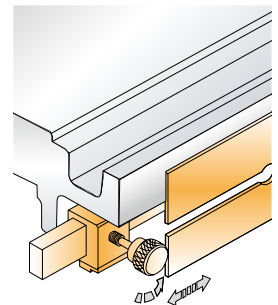

Table Reversing Mechanism

By electronic non-contact reverser, operator can easily set suitable table stroke for each workpiece to save grinding time and obtain higher grinding efficiency. The proximity switches are properly covered for operator's safety.



FSG-2A1224

Note: Machine shown with optional accessories

FSG-2A1224 · 3A1224 Series

Automatic Surface Grinder

Permissible Load of Machine

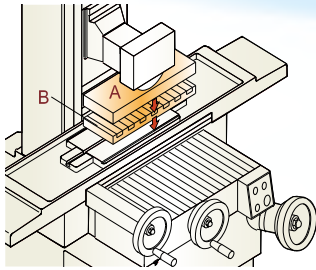

Grinding with
Electromagnetic Chuck

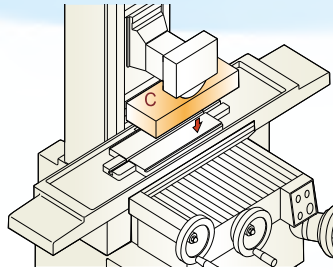

Grinding without
Electromagnetic Chuck

The total suggested maximum workloads of table are shown as follows:

Model	FSG-2A1224	FSG-3A1224
A	314 (691)	
B	106 (233)	
C	420 (924)	

kg (lb)

Control Station (3A Series)

The control station can be adjusted to a comfortable position for operator. All switches, indicators, lamps, LEDs, and displays are designed as ergonomic concept for easy operation.

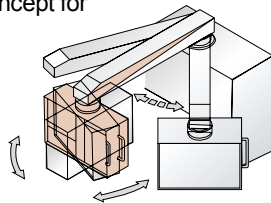

Elevating Micro-Feed Device (3A Series)

The stepping downfeed device is very convenient for rough- and fine-grinding. By pushing down the step-feed button, the infeed wheelhead will be 25 μm (0.00001") or 5 μm (0.0002") selected by a selector at the top of this device. At the upper position there is an adjustable handle for approaching and rough-grinding.

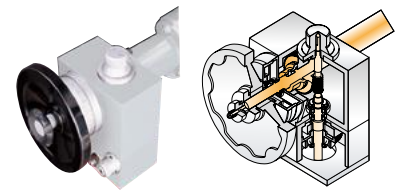

FSG-3A1224

Note: Machine shown with optional accessories

Optional Accessories



Halogen Lamp

B01-0101 (618M, 2A618, 612SP, 618SP, 818SP)
B01-0601 (3A818)
B01-0901 (2A818)
(12V / 20W)



Machine Lamp

B01-0903 (2A, 3A1224)
(12V / 50W)



Diamond Dresser

B03-0101 (618M, 2A618)
0.1 Carat
B03-0401 (2A, 3A1224)
1.0 Carat



Diamond Dresser

B03-0601
(2A, 3A818, 612SP, 618SP, 818SP)
0.5 Carat



Single Face Dresser

B13-0301 (2A, 3A1224)



Wheel Flange

B05-0101 (618M, 2A618, 612SP, 618SP, 818SP, 2A, 3A818)
Suitable for $\varnothing 203 \times \varnothing 31.75 \times 12.7 \sim 19$ mm
($\varnothing 8'' \times \varnothing 1 \frac{1}{4}'' \times 0.5'' \sim 0.7''$) grinding wheel



Wheel Flange

B05-0401 (2A, 3A1224)
Suitable for $\varnothing 355 \times \varnothing 127 \times 50$ mm
($\varnothing 13.98'' \times \varnothing 5'' \times 1.97''$) grinding wheel



Punch Former

B07-01011
Diameter of the punch: 4~25 mm
(0.16'' ~1'')
Length of the punch: over 22 mm (0.9'')



Permanent Magnetic Chuck

B09-0102 (618M, 2A618)
150 x 450 mm (5.9" x 17.7")
B09-0103 (2A, 3A818, 818SP)
200 x 450 mm (7.9" x 17.7")
B09-0101 (612SP)
B09-0602 (612SP) (fine pole)
150 x 300 mm (5.9" x 11.8")
B09-0102 (618SP)
B09-0110 (618SP) (fine pole)
150 x 450 mm (5.9" x 17.7")
B09-0103 (818SP)
B09-0604 (818SP) (fine pole)
200 x 450 mm (7.9" x 17.7")



Inclinable Magnetic Chuck

B09-0104 (612SP)
100 x 175 mm (3.9" x 6.9")
B09-0105 (618M, 2A618, 618SP, 818SP, 2A, 3A818)
150 x 300 mm (5.9" x 11.8")



Electromagnetic Chuck

B09-0605 (612SP)
B09-0608 (612SP) (fine pole)
150 x 300 mm (5.9" x 11.8")
B09-0106 (618M, 2A618, 618SP)
150 x 450 mm (5.9" x 17.7")
B09-06071 110V (2A, 3A818)
200 x 450 mm (7.9" x 17.7")
* To order B23-0701 (2A) or B23-0602 (3A) chuck control is required.
B09-0609 (618SP) (fine pole)
150 x 450 mm (5.9" x 17.7")
B09-0607 (818SP)
B09-0610 (818SP) (fine pole)
200 x 450 mm (7.9" x 17.7")
* To order B23-0901 control is required.
B09-04011 (2A, 3A1224)
300 x 600 mm (11.8" x 23.6")
* To order B23-0701 (2A) or B23-0602 (3A) chuck control is required.



Inclinable Electromagnetic Chuck

B09-0601 (618M, 2A618)
150 x 450 mm (5.9" x 17.7")
B09-1101 (612SP)
100 x 175 mm (3.9" x 6.9")
B09-0107 (618SP, 818SP)
150 x 300 mm (5.9" x 11.8")
B09-09011 100V (2A, 3A818)
200 x 300 mm (7.9" x 11.8")
* To order B23-0701 (2A) or B23-0602 (3A) chuck control is required.



Precision Vise

B11-0101 50 x 76 mm (2" x 3")
B11-0102 63 x 100 mm
(2.5" x 3.9")
B11-0103 76 x 100 mm (3" x 3.9")
B11-0104 89 x 127 mm (3.5" x 5")
B11-0105 100 x 127 mm (3.9" x 5")



Parallel Dressing Attachment (Manual)

B13-0101 (618M, 2A618)
B13-1101 (612SP, 618SP, 818SP)
B13-0603 (2A, 3A818)
Suitable for $\varnothing 203$ mm ($\varnothing 8''$) grinding wheel
B13-0902 (2A, 3A1224)
Max. OD: $\varnothing 355$ mm (13.98")
Min. OD: $\varnothing 235$ mm (9.25")

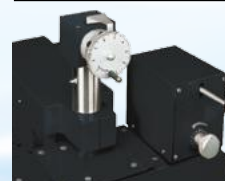

Parallel Dressing Attachment (hydraulic crossfeed, manual downfeed)

B13-04011 (2A, 3A1224)
Max. OD: $\varnothing 355$ mm ($\varnothing 13.98''$)
Min. OD: $\varnothing 235$ mm ($\varnothing 9.25''$)



Parallel Dressing Attachment (hydraulic crossfeed, manual downfeed)

B13-0601 (2A, 3A818)
Suitable for $\varnothing 203$ mm ($\varnothing 8''$) grinding wheel



Rapid Elevation with Micro Downfeed Device

(Standard on 3A series)
B39-0901 (2A818, 1224)
Motor: 0.19 kW (1/4 HP)
Micro feed: Per revolution 0.2 mm (0.01")
Per graduation 0.002 mm (0.0001")



Micro Crossfeed Device

B39-1101 (612SP, 618SP, 818SP)
Per revolution 0.1 mm (0.005")
Per graduation 0.001 mm (0.00005")



Rapid Elevation Device

B39-1102 (612SP, 618SP, 818SP)
Motor: 0.19 kW (1/4 HP)
Speed: 175 mm/min (8.75 ipm) - 60Hz
Speed: 145 mm/min (7.25 ipm) - 50Hz



Elbe Grinding Wheel

(for mirror surface grinding)
5915-44211002
(81A46-3K9V26) (612SP, 618SP, 818SP)
5915-44211005
(81A46-3112V26) (612SP, 618SP, 818SP)



Single Side Water Baffle

B19-0906 (2A, 3A818)

Double Side Water Baffle

B19-0910 (2A, 3A1224)



Splash Guard

(with nozzle for coolant system)

B19-0102 (618M, 2A618)

B19-0909 (2A, 3A818)

B19-1101 (612SP)

B19-1102 (618SP, 818SP)

B19-0907 (2A, 3A1224)



Balancing Stand with Bubble

B15-0102

(612SP, 618SP, 818SP, 2A, 3A818)

Suitable for Ø230 mm (Ø9") grinding wheel



Balancing Stand (roller type)

B15-0601

Suitable for Ø203~355 mm (Ø8"~13.98") grinding wheel

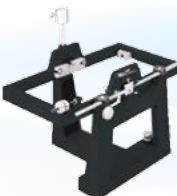

Balancing Stand with Leveling Bubble

B15-0301 (2A, 3A1224)

Max. OD: Ø355 mm (Ø13.98")

Max. width: 50 mm (1.97")



Universal Wheel Guard for Side Forming

B41-0106 (618M, 2A618)

B41-1101 (612SP, 618SP, 818SP)

B41-0901 (2A, 3A818)

Suitable for: Ø203 mm (Ø8") grinding wheel



Micro Downfeed Device

(Standard on 3A series)

B39-0902 (2A818, 1224)

Micro feed: Per revolution 0.2 mm (0.01")

Per graduation 0.002 mm (0.0001")



Chuck Controller

(with variable holding power and auto demagnetizer)

B23-0106 (618M, 2A618, 612SP, 618SP, 818SP)

Input: 110 V AC

Output: 0~90 V DC



Chuck Controller

B23-0401 (3A818, 3A1224 CE machines and 2A818, 3A1224, 2A1224)

Input: 135 V AC

Output: 110 V DC



Chuck Controller

B23-0602 (3A818, 3A1224)

Input Voltage: 135 V AC

Output Voltage: 110 V DC

with variable holding power control and auto. demagnetizer (for CE machines, please choose B23-0401).



Coolant System

B17-0110

Volume: 42 L

Pump: 1/8 HP

Coolant capacity: 20 L/min.

Space: 530 x 360 mm (20.87" x 14.2")

Height: 500 mm (19.7")



Coolant System with Double Filter

B17-0901

Volume: 95 L; Pump: 1/8 HP

Coolant capacity: 20 L/min.

Space: 660 x 480 mm (26" x 18.9")

Height: 610 mm (24")



Coolant System with Manual Paper Feeding Device

(with 1 roll of paper)

B17-0107 (2A, 3A1224)

Volume: 85 L; Pump: 1/8 HP

Coolant capacity: 20 L/min.

Space: 550 x 1,000 mm

(21.7" x 39.4")

Height: 775 mm (30.5")

Optional Accessories

Coolant System with Automatic Paper Feeding Device (with 1 roll of paper)



B17-0301 (2A, 3A1224)
 Volume: 120 L
 Paper feeding motor: 25 W
 Pump: 1/8 HP
 Space: 1,450 x 620 mm (57.1" x 24.4")
 Height: 760 mm (29.9")

Combination Coolant and Dust Exhaust Unit with Magnetic Separator



B17-0106
 Volume: 34 L
 Pump: 1/8 HP
 Coolant capacity: 20 L/min.
 Separator capacity: 20 L/min.
 Space: 628 x 790 mm (24.7" x 31.1")
 Height: 680 mm (26.8")

Coolant System with Automatic Paper Feeding Device and Magnetic Separator



(with 1 roll of paper)
B17-0302
 Volume: 120 L
 Paper feeding motor: 25 W
 Pump: 1/8 HP
 Coolant capacity: 20 L/min.
 Separator capacity: 40 L/min.
 Space: 1,450 x 620 mm (57.1" x 24.4")
 Height: 760 mm (29.9")

Combination Coolant and Dust Exhaust Unit



B17-0101
 Volume: 34 L
 Pump: 1/8 HP
 Coolant capacity: 20 L/min.
 Space: 398 x 798 mm (15.7" x 31.4")
 Height: 680 mm (26.8")

Coolant System with Magnetic Separator



B17-0105
 Volume: 50 L
 Pump: 1/8 HP
 Coolant capacity: 20 L/min.
 Separator capacity: 20 L/min.
 Space: 655 x 520 mm (25.8" x 20.5")
 Height: 730 mm (28.7")

Dust Collector



B17-0102
 Suction motor: 1/2 HP, 2 P
 Space: 470 x 500 mm (18.5" x 19.7")
 Height: 585 mm (23")

Standard Accessories

- Tool box
- Semicircle wrench
- Extractor nut
- Balancing arbor
- Leveling pads
- Leveling bolt
- Plugs
- Lifting lever
- Phillips head screws
- Headless screws
- Cross screwdriver
- Slotted screwdriver
- Hex. wrench
- Grinding wheel
- Wheel flange

Dimensional Drawings

ACCUGRIND-612SP / 618SP / 818SP

Unit: mm(")

Model	612SP	618SP	818SP
A	1,750 (68.89)	2,040 (80.3)	
B		685 (26.97)	
C	1,870 (73.6)	2,134 (84)	
D		1,360 (53.5)	
E		12.7 (0.5)	
F		267 (10.5)	
G		11 (0.433)	
H	152 (5.98)		200 (7.87)
I	225 (8.9)		254 (10)
J	244 (9.6)		242 (9.5)
K		500 (19.69)	
L		203 (7.99)	
M		50 (1.96)	

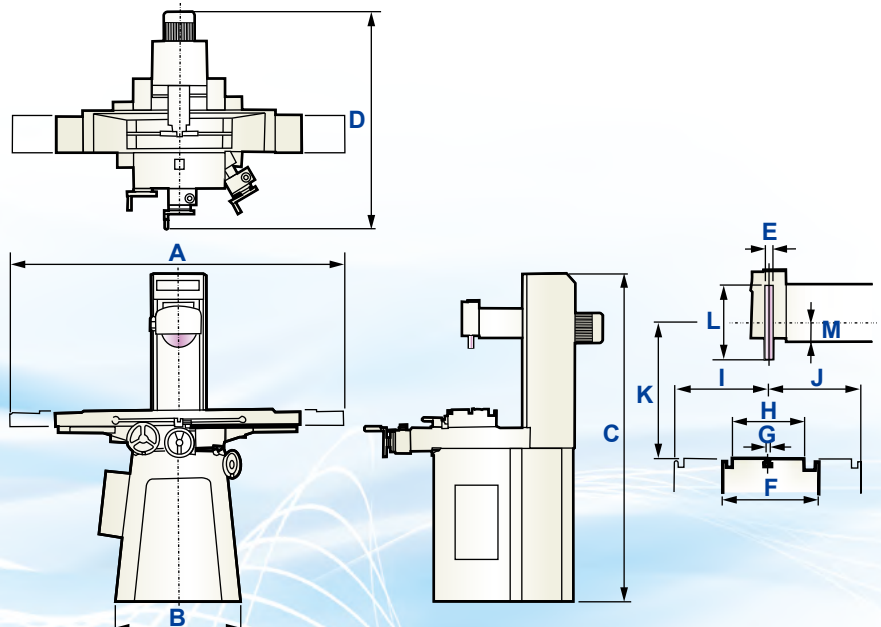

Dimensional Drawings

FSG-618M / 2A618

Unit: mm(")

Model	FSG-618M / FSG-2A618
A	1,900 (74.8)
B	690 (27.2)
C	2,130 (83.86)
D	1,400 (55.12) 1,600 (62.99)
E	12.7 (0.5)
F	200 (7.9)
G	11 (0.4)
H	146 (5.7)
I	197 (7.8)
J	183 (7.2)
K	450 (17.7)
L	203 (7.99)
M	50 (1.97)

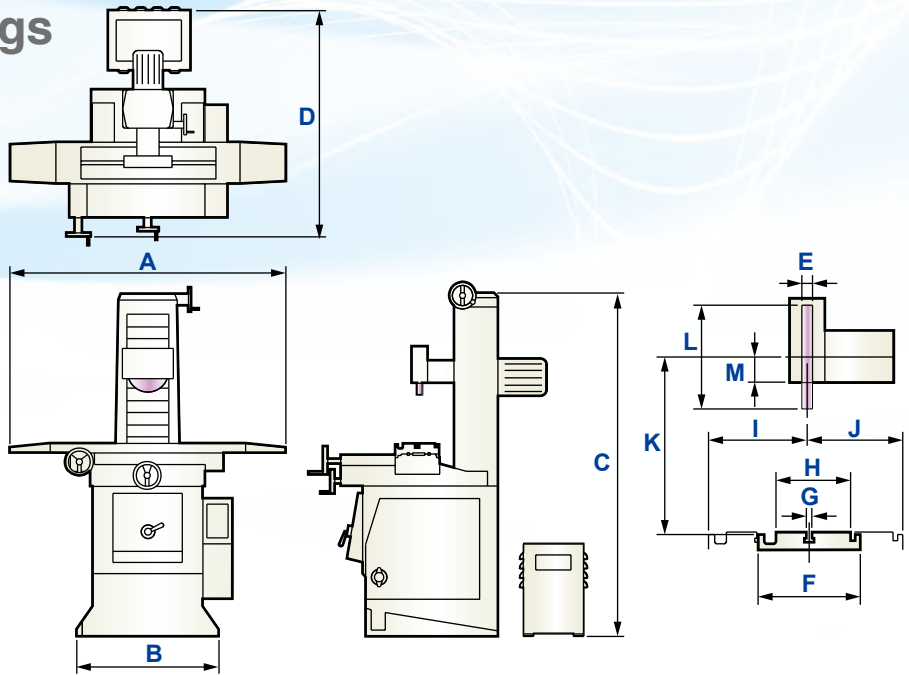

FSG-2A818 / 3A818

Unit: mm(")

Model	FSG-2A818 / FSG-3A818
A	2,200 (86.6)
B	690 (27.2)
C	1,950 (76.77)
D	12.7 (0.5)
E	305 (12)
F	12 (0.5)
G	206 (8.1)
H	274 (10.8)
I	271 (10.7)
J	450 (17.7)
K	203 (8)
L	54 (2.1)

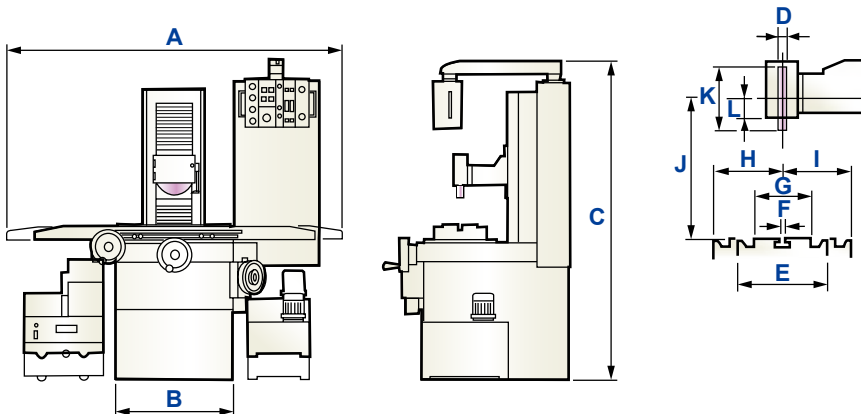

FSG-2A1224 / 3A1224

Unit: mm(")

Model	FSG-2A1224 / 3A1224
A	2,670 (105.1)
B	920 (36.2)
C	2,050 (80.71)
D	1,810 (71.3)
E	50 (1.97)
F	402 (15.8)
G	14 (0.6)
H	305 (12)
I	385 (15.2)
J	387 (15.2)
K	MAX.: 600 (23.6)
L	355 (13.98)
M	83 (3.3)

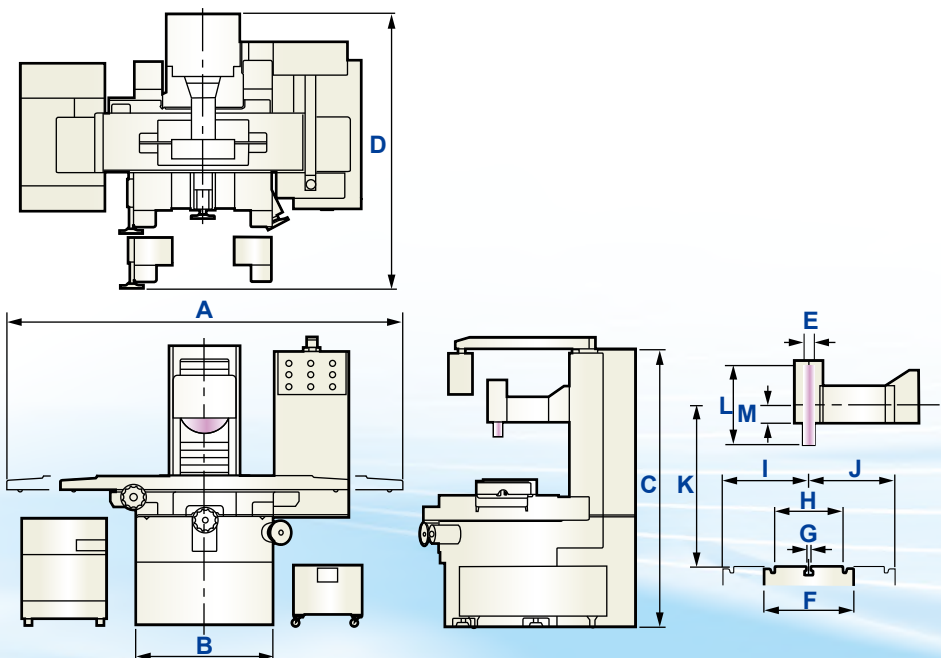

Specification

Description		612SP	618SP	818SP
Table Size		152 x 330 mm (6" x 13")	152 x 480 mm (6" x 19")	203 x 480 mm (8" x 19")
Max. Grinding Length	Longitudinal	355 mm (14")	500 mm (19")	
Max. Grinding Width	Crosswise	203 mm (8")		230 mm (9")
Max. Distance from Table		500 mm (19")		
Standard Magnetic Chuck Size		150 x 300 mm (5.9" x 11.8")	150 x 450 mm (5.9" x 17.7")	200 x 450 mm (7.9" x 17.7")
Longitudinal Movement of Table	Travel, Hydraulic	N/A		
	Max. Travel, Manual	360 mm (14")	510 mm (20")	
	Table Speed, Variable	N/A		
Cross Movement of Table	Rapid Travel, Approx.	N/A		
	Auto Increment	N/A		
	Max. Automatic Travel	N/A		
	Max. Manual Travel	203 mm (8")	230 mm (9")	
	Handwheel Per Revolution	5 mm (0.2")		
	Handwheel Per Graduation	0.02 mm (0.001")		
	Micro Feed	Optional 0.001 mm (0.00005")		
Wheelhead Vertical Infeed	Automatic Infeed	N/A		
	Handwheel Per Revolution	1 mm (0.05")		
	Handwheel Per Graduation	0.005 mm (0.0001")		
	Rapid Travel, Approx.	Optional 330 mm/min (13 ipm)		
	Micro Feed	Per Revolution	0.1 mm (0.001")	
Per Graduation		0.001 mm (0.00005")		
Grinding Spindle Drive	Speed	60 Hz / 3,450 rpm, 50 Hz / 2,850 rpm		
	Power Rating	1.5 kW (2 HP)		
Hydraulic Drive	Power Rating	N/A		
Crossfeed Drive	Power Rating	N/A		
Elevating Drive	Power Rating	Optional 0.19 kW (1/4 HP)		
Standard Grinding Wheel	Diameter	Ø203 mm (8")		
	Width	Optional 12.7 mm (0.5"), Max. 25.4 mm (1")		
	Bore	Ø31.75 mm (1 1/4")		
Machine Dimensions	Floor Space (L x W x H)	1,750 x 1,360 x 1,870 mm (69" x 53.5" x 73.6")	2,040 x 1,360 x 2,134 mm (80" x 53.5" x 84")	
	Net Weight (Approx. Based on 3A)	1,050 kg (2,314 lb)		
Rated Power (Approx.)		1.65 kW (2.2 HP)		

• All content is for reference only and may be subject to change without notice or obligation.

FSG-618M		FSG-2A618		FSG-2A818		FSG-3A818		FSG-2A1224		FSG-3A1224	
146 x 460 mm (5.7" x 18")				203 x 457 mm (8" x 18")				305 x 610 mm (12" x 24")			
457 mm (18")				457 mm (18")				610 mm (24")			
152 mm (6")				203 mm (8")				305 mm (12")			
450 mm (17")				450 mm (17")				600 mm (23.6")			
150 x 450 mm (5.9" x 17.7")				200 x 450 mm (7.9" x 17.7")				300 x 600 mm (11.8" x 23.6")			
N/A		500 mm (19.7")		500 mm (19.7")				650 mm (25.6")			
482 mm (19")		510 mm (20")		530 mm (21")				700 mm (27.6")			
N/A		5~25 m/min (16~82 fpm)		5~25 m/min (16~82 fpm)				5~25 m/min (16~82 fpm)			
N/A		960 mm/min (48 ipm)		960 mm/min (48 ipm)				1,100 mm/min (56 ipm)			
N/A		0.4~6 mm (0.02"~0.24")		0.4~6 mm (0.02"~0.24")				1~12 mm (0.04"~0.5")			
N/A		171 mm (6.7")		230 mm (9")				360 mm (14.2")			
180 mm (7")				240 mm (9.4")				370 mm (14.6")			
3 mm (0.1")				4 mm (0.2")				4 mm (0.2")			
0.01 mm (0.005")				0.02 mm (0.001")				0.02 mm (0.001")			
N/A				N/A				N/A			
N/A				N/A		0.002~0.04 mm (0.0001"~0.002")		N/A		0.002~0.04 mm (0.0001"~0.002")	
1 mm (0.05")				2 mm (0.1")				2 mm (0.1")			
0.005 mm (0.0001")				0.01 mm (0.0005")				0.01 mm (0.0005")			
N/A				N/A		330 mm/min (13 ipm)		N/A		330 mm/min (13 ipm)	
N/A				N/A		0.2 mm (0.1")		N/A		0.2 mm (0.1")	
N/A				N/A		0.002 mm (0.0001")		N/A		0.002 mm (0.0001")	
60 Hz / 3,450 rpm, 50 Hz / 2,850 rpm				60 Hz / 3,450 rpm, 50 Hz / 2,850 rpm				60 Hz / 1,750 rpm, 50 Hz / 1,450 rpm			
1.5 kW (2 HP)				1.5 kW (2 HP)				3.7 kW (5 HP)			
N/A		0.75 kW (1 HP)		0.75 kW (1 HP)				1.5 kW (2 HP)			
N/A		40 W (0.05 HP)		40 W (0.05 HP)				40 W (0.05 HP)			
N/A				Optional 0.19 kW (1/4 HP)		Standard 0.19 kW (1/4 HP)		Optional 0.19 kW (1/4 HP)		Standard 0.19 kW (1/4 HP)	
Ø203 mm (8")				Ø203 mm (8")				Ø355 mm (14")			
12.7 mm (0.5")				12.7 mm (0.5")				50 mm (2")			
Ø31.75 mm (1 1/4")				Ø31.75 mm (1 1/4")				Ø127 mm (5")			
1,900 x 1,400 x 2,130 mm (75" x 55" x 84")		1,900 x 1,600 x 2,130 mm (75" x 63" x 84")		2,200 x 1,575 x 1,950 mm (86" x 62" x 76")				2,670 x 1,810 x 2,050 mm (105" x 71" x 80")			
674 kg (1,485 lb)		790 kg (1,741 lb)		1,250 kg (2,755 lb)		1,320 kg (2,910 lb)		2,300 kg (5,070 lb)			
1.65 kW (2.2 HP)		2.5 kW (3.3 HP)		3.7 kW (5 HP)				7.4 kW (10 HP)			



Grinding Machine



Grinding Machine



Turning Machine



Milling Machine

Headquarters

FALCON MACHINE TOOLS CO., LTD.
No. 34, Hsing Kong Road, Shang Kang,
Chang Hua TAIWAN 50971
Tel: +886 4 799 1126
Fax: +886 4 798 0011
www.chevalier.com.tw
overseas@chevalier.com.tw

FULSON INDUSTRIAL CO., LTD
No. 12, Longshan 2nd St., Daya Dist.,
Taichung City TAIWAN 42863
Tel: +886 4 2567 6811
Fax: +886 4 2567 4440
E-mail: fssales@chevalier.com.tw

China Headquarters

CHEVALIER MACHINERY CO., LTD. (SUZHOU)
No.58, Huangpu River Rd., Southeast High-tech Development
Zone, Changshu City, Suzhou City, China 215500
Tel: +86 512 82355999
Fax: +86 512 82355966
http://www.sz-chevalier.com

U.S.A. Headquarters

CHEVALIER MACHINERY INC.
9925 Tabor Place, Santa Fe Springs, CA
90670 U.S.A.
Tel: (562) 903 1929
Fax: (562) 903 3959
http:// www.chevalierusa.com
E-mail: info@chevalierusa.com