



# 脫壓式油脂潤滑系統

Pressure relief Grease Lubrication System



永鈿潤滑科技有限公司  
YUNG TIEN LUBRICATION TECHNOLOGY CO., LTD.

台中市神岡區大豐路五段295巷21號  
NO.21, LANE 295, SEC 5, DAFENG RD., SHENGANG  
DIST., TAICHUNG CITY 429, TAIWAN  
TEL:886-4-25284429 FAX:886-4-25242345  
E-mail: chiba.tw@gmail.com  
<http://www.chiba.com.tw>

大陸辦事處：

東莞功昱機械五金有限公司

東莞市長安鎮廈崗復興路33號金銘國際工業模具城8棟7B  
TEL:0769-81666313 手提：13662900729



## MSK-1FW

# 脫壓式油脂潤滑系統

PRESSURE RELIEF GREASE LUBRICATION SYSTEM

## 架構圖 CONSTRUCTION

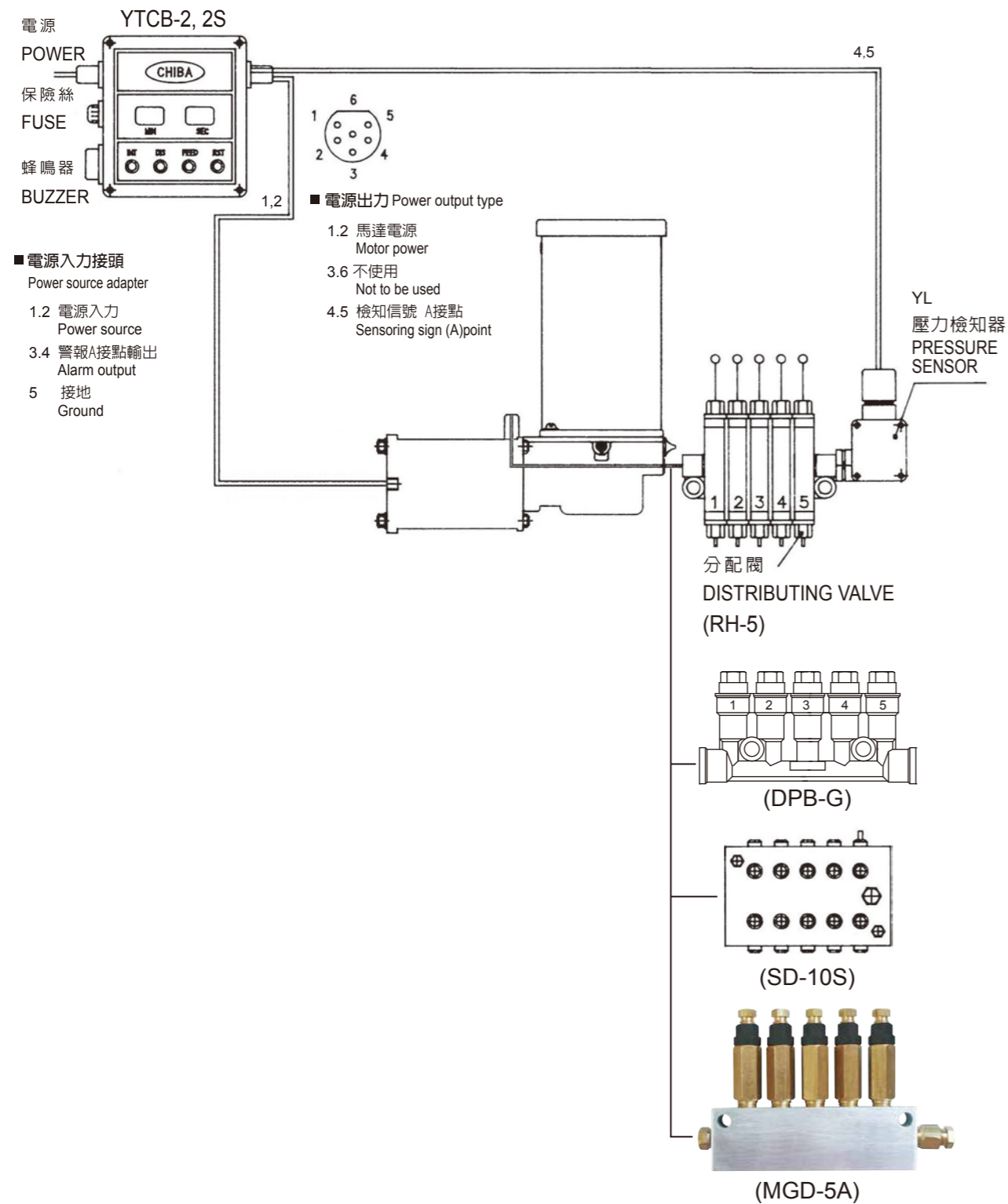

# YTCB-2S 控制盒 CONTROL BOX

計時控制盒附壓力回饋檢知  
With timer controller pressure & feedback sensor

## 外觀及安裝尺寸 DIMENSION



YTCB-2, 2S  
(適用MSK-1W機型)

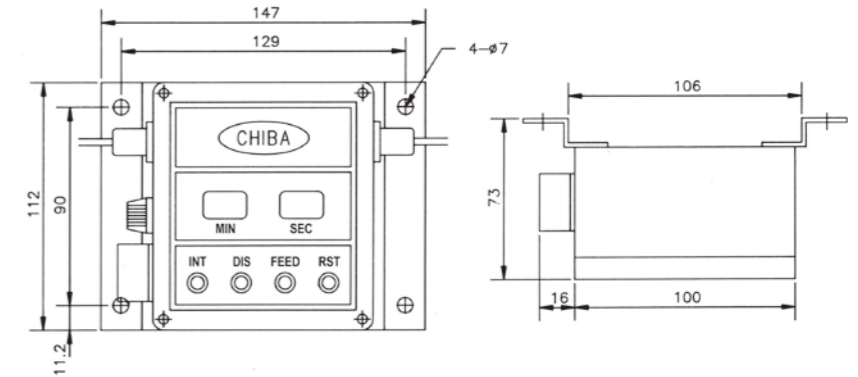

## 功能鍵操作說明 OPERATION OF TIME CONTROL

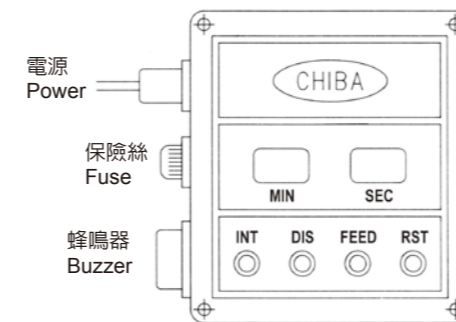

出力 1, 2  
檢知信號 4, 5

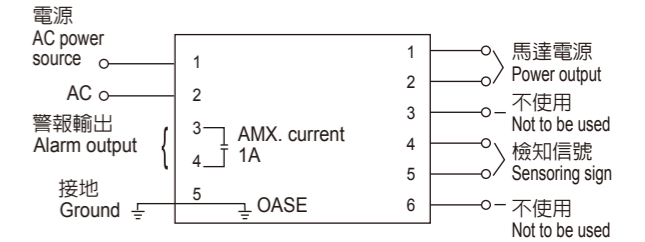

- ◎ RST鍵 係依DIS設定之秒數手動注油。  
A key for manual oiling according to seconds set by DIS key.
- ◎ FEED鍵 係手動控制注油(鬆手即停)。  
A key for manual oiling control (stop upon release).
- ◎ DIS鍵 幫浦每次運轉時間之設定鍵，運轉時間由1-99秒自由設定。  
A key for setting motor time of pump off-time set is available for 1-99 seconds.
- ◎ INT鍵 每次運轉間隔時間之設定鍵，停止時間由1-99小時自由設定。  
A key for setting motor interval off-time set is available for 1-99 hours.

1. 使用電源: AC1 φ 110V/220V 50/60HZ
2. 過載保險絲: 3A 安培
3. 警報輸出最大電流: 1A 安培
4. 控制碼達出力最大電流: 3A 安培
5. 用途: 適用於各種機械之潤滑

1. Power: AC1 φ 110V/220V 50/60Hz
2. Overload fuse : 3A
3. Alarm output circuit (max): 1A
4. Motor power (max): 3A
5. Purpose: applicable for various machinery lubrication

## 壓力開關 PRESSURE SWITCHES

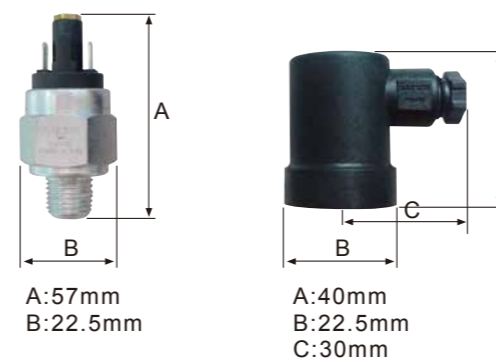

型式 Model	牙規格 Bore type	ON
PME-50A14K	1/4PT	1~50 KG

### MSK-1FW | 電動脫壓式黃油幫浦 Pressure Relief Grease Pump

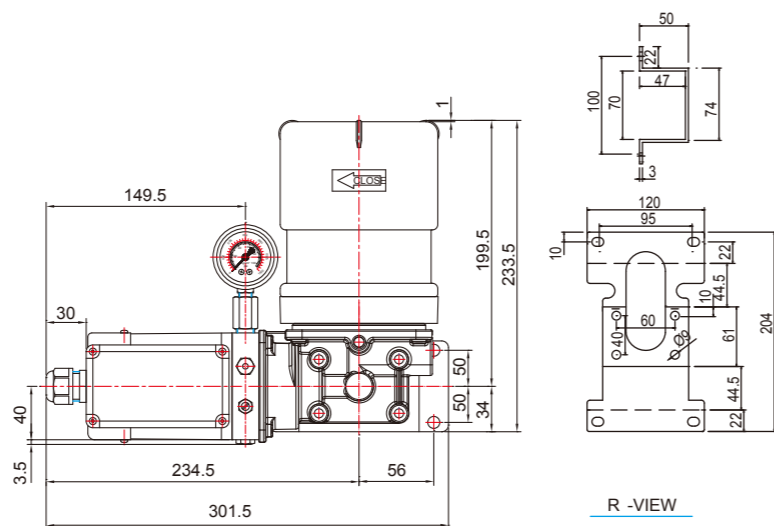

#### 規格表 SPECIFICATION

型式 Model	流量 Flow	電壓 Voltage	馬達功率 Power	油箱容量 Oil tank Capacity	最大吐出壓力 Maximum Output Pressure	油脂範圍 Oil viscosity
MSK-101W	200cc/MIN	110V	60W	700cc	50KG/CM <sup>2</sup>	00#, 000#
MSK-102W	200cc/MIN	220V	60W	700cc	50KG/CM <sup>2</sup>	00#, 000#
MSK-124W	200cc/MIN	DC-24V	60W	700cc	50KG/CM <sup>2</sup>	00#, 000#

#### 功能特長 FUNCTION AND FEATURES

- 由馬達控制齒輪、邦浦油量輸出穩定、無噪音、壓力大
- 可由PLC控制間歇及運轉時間
- 可設壓力檢知檢測管路輸送壓力是否達到所需標準
- 可配合：A. 單一循環分配器 B. 脫壓式分配器 C. 加壓式分配器  
使用定時定量給油，減少不必要的流失
- 使用00#.000#油脂，環保潤滑效果好，也不需常常加油，經濟效率高
- 幫浦設有壓力調整過載閥，以保護馬達及管路正常壓力
- 請以正確方式充填加油以免油箱空氣產生而導致潤滑不良

- The gear is controlled by motor, stable pump oil outlet, no noisy, strong pressure.
- The interval time and running time are controlled by PLC.
- Setting pressure sensing system could be an option to detect the tube convey pressure whether achieve required standard or not.
- In order to maintain on-time and PDI efficiency, extra options provided:  
A. Single cycle oil distributor SD type    B. Pressure-relief type oil distributor  
C. Compress type oil distributor
- Choosing 00#.0# .1# grease to ensure highly lubrication and economy efficiency.
- The pressure overload adjusting valve can protect motor and ensure the oil tube in normal.
- Always fill oil through oil hole to avoid bad lubricant effects due to non-vacuum status.

### FS-2 | 拋棄式油條 Disposable Oil



- 油脂規格 Viscosity : 00#.000#
- 容量 Capacity : 700CC
- 特點說明 Features:  
耐高壓、耐磨耗、耐熱不變質、及耐水之潤滑油  
Resist high pressure, Wearproof,  
Resist hot and not go bad, Waterproof lubricate.

### RH | 定量容積式分配器 (油脂) Quantitative Oil Distributor

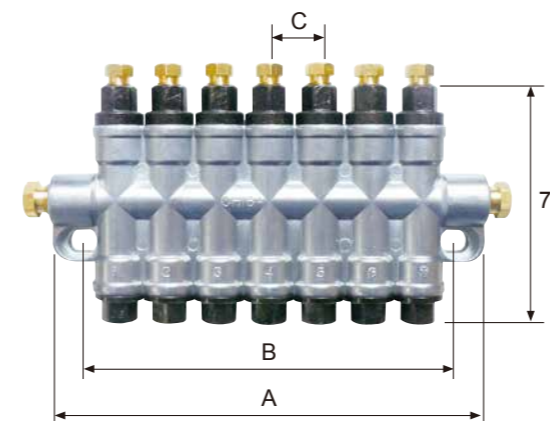

#### RH - 1(0.3cc)

吐出量 Discharge volume: 0.1c.c ~ 0.5cc  
吐出口數 Vomiting number: 1~7

型式 Model	吐出口數 Vomiting number	吐出量 Discharge volume	最低作動壓力 Minimum performance pressure	尺寸 Size mm		
				A	B	C
RH	1	0.1	35 kg/cm <sup>2</sup>	35	23	15
	2			50	39~43	15
	3			65	51~58	15
	4			80	66~73	15
	5			95	81~88	15
	6			110	96~103	15
	7			130	111~118	15

### SD-6S | SD單一循環式分配器 Single Cycle Oil Distributor

#### SD-6S

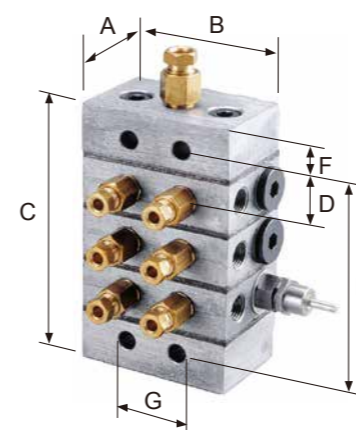

#### YSA-1



#### SD-6S

檢知訊號 Detect sensor  
出油口數 number:

型式 Model	最大使用壓力 Mox. operating pressure	適用黃油 Recommended grease	吐出量 Discharged amount (cc/st)
SD	140kg/cm <sup>2</sup>	NLG1 No. 00~1	0.1, 0.14, 0.18, 0.24, 0.3

型式 Model	A	B	C	D	E	F	G
SD-2~6	35	54	85	16	65	10.5	19
SD-7-8	35	54	102	16	82	10.5	19
SD-9-10	35	54	119	16	99	10.5	19
SD-11.12	35	54	136	16	116	10.5	19
SD-13.14	35	54	153	16	133	10.5	19
SD-15.16	35	54	170	16	150	10.5	19

**MGD | 加壓式定量分配器** Positive Displacement Injector Distributor

MGD-5A

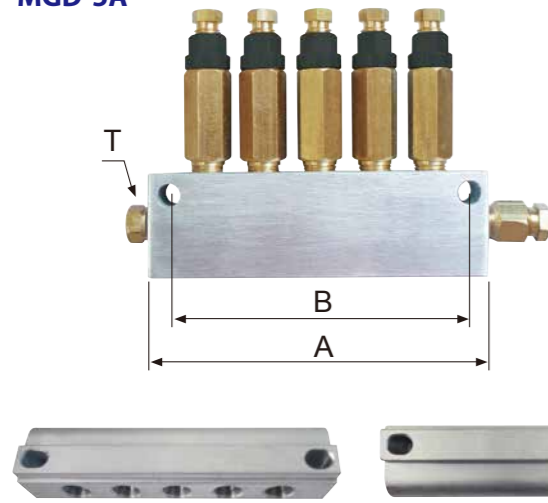

MGD - 2A- 05

吐出量 Discharge volume: 0.03cc ~ 0.16cc  
 A: 鋁排 Aluminum, B: 壓鑄 Casting  
 吐出口數 Vomiting number: 2~10

MGD-5B

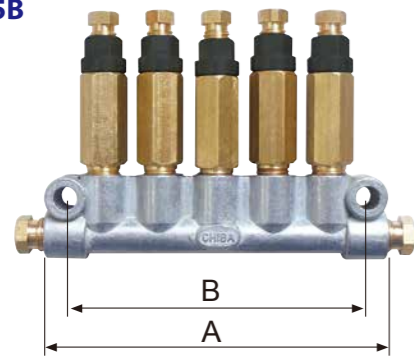

型式 Model	吐出口數 Number of port	A (m/m)	B (m/m)	T	吐出量 Discharged amount
MGD-2	2	48	36	M10*1.0	0.03 0.06 0.10 0.16
MGD-3	3	64	52	M10*1.0	
MGD-4	4	80	68	M10*1.0	
MGD-5	5	96	84	M10*1.0	
MGD-6	6	112	100	M10*1.0	
MGD-7	7	128	116	M10*1.0	
MGD-8	8	144	132	M10*1.0	
MGD-10	10	176	164	M10*1.0	

**DPB-1G | 加壓式定量分配器** Positive Displacement Injector System Distributor

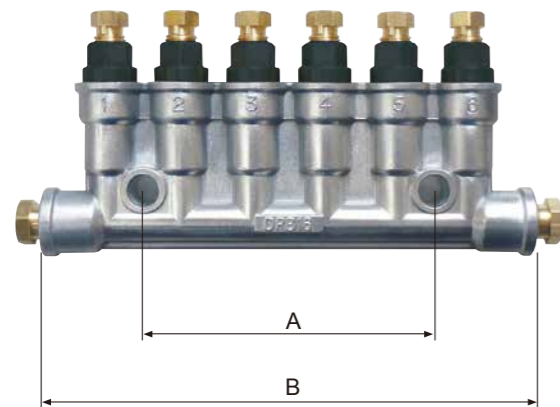

DPB-12G (0.03)

吐出量 Discharge volume:(0.03 ~0.16)  
 油品: 油脂 Grease  
 吐出口數 Vomiting number: 1~10

型式 Model	吐出口數 Vomiting number	吐出量 Discharged amount	A	B
DPB-12G	2	0.03	-	48
DPB-13G	3		17	65
DPB-15G	5	0.06	51	99
DPB-16G	6		68	116
DPB-18G	8	0.1	102	150
DPB-110G	10		136	184

**DPB-2G | 加壓式定量分配器** Positive Displacement Injector System Distributor

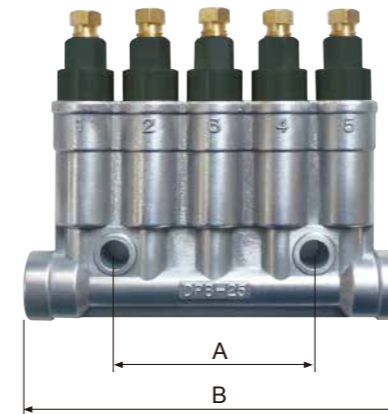

型式 Model	吐出口數 Vomiting number	吐出量 Discharged amount	A	B
DPB-22G	2	0.1	-	48
DPB-23G	3		17	65
DPB-25G	5	0.2	51	99
DPB-26G	6		68	116
DPB-28G	8	0.4	102	150
DPB-210G	10		136	184

**MG | 定量閥** Quantitative Valve

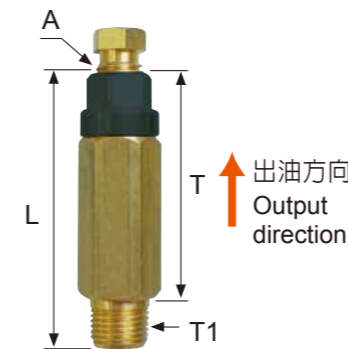

MG - 003

吐出量 Discharge volume: 0.03cc ~ 0.16cc

型式 Model	吐出量 Discharged amount	記號	T (m/m)	L (m/m)	A	T1
MG	0.03	03	36.5	44	M8*1.0	PT 1/8
	0.06	06				
	0.10	10				
	0.16	16				

- 作動壓力 Performance pressure : 2.5 MPa
- 回復壓力 Restore the pressure : 1.2 MPa

**MGT | 定量閥** Quantitative Valve

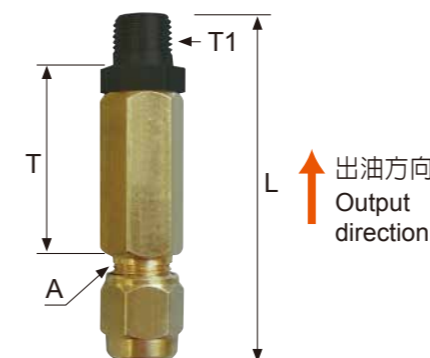

MGT - 003

吐出量 Discharge volume: 0.03cc ~ 0.16cc

型式 Model	吐出量 Discharged amount	記號	T (m/m)	L (m/m)	A	T1
MGT	0.03	03	30	47	M10*1.0	PT 1/8
	0.06	06				
	0.10	10				
	0.16	16				

- 作動壓力 Performance pressure : 2.5 MPa
- 回復壓力 Restore the pressure : 1.2 MPa

連接頭 Connector

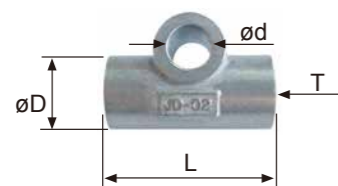

單位Unit: mm

型式 Model	管徑 DIA	ød	øD	L	T
JD2-4	ø4	6.5	13	28	M8x1.0
JD2-6	ø6	6.5	13	28	M10x1.0

三通管 Triform Tube

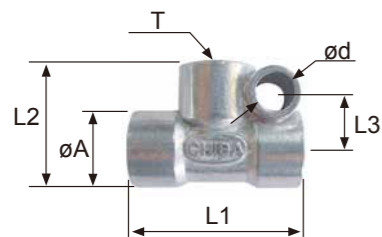

單位Unit: mm

型式 Model	管徑 DIA	øA	L1	L2	L3	ød	T	HEX
PKD-4	ø4	11	28	14	8.1	6.5	M8x1.0	11
PKD-6	ø6	14	30	15	9.2	6.5	M10x1.0	14
PKD-8	ø8	18	40	20	12.0	6.5	M14x1.5	18
PKD-10	ø10	20	45	22.5	13.5	6.5	M16x1.5	20

四通管 Four Sides Tube

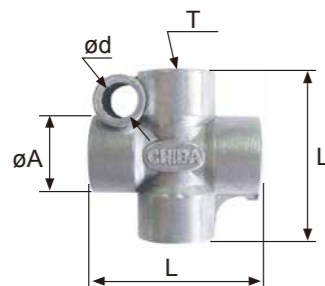

單位Unit: mm

型式 Model	管徑 DIA	øA	ød	L	T	厚度
PJD-404	ø4	11	6.5	28	M8x1.0	11
PJD-406	ø6	14	6.5	28	M10x1.0	14

分配器 Distributor

DB-8

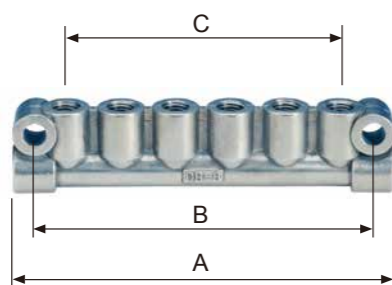

單位Unit: mm

型式 Model	接頭口數	A	B	C
DB-4	4	48	36	16
DB-5	5	64	52	32
DB-6	6	80	68	48
DB-7	7	96	84	64
DB-8	8	112	100	80
DB-9	9	128	116	96
DB-10	10	144	132	112
DB-12	12	176	164	144

分配器 Distributor

DA-12

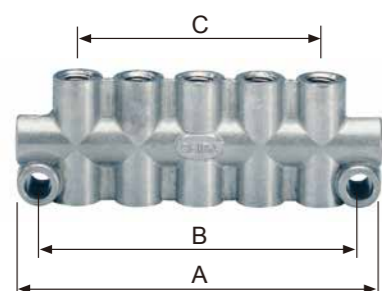

單位Unit: mm

型式 Model	接頭口數	A	B	C
DA-6	6	48	36	16
DA-8	8	64	52	32
DA-10	10	80	68	48
DA-12	12	96	84	64
DA-14	14	112	100	80
DA-16	16	128	116	96
DA-18	18	144	132	112

高壓管 High Pressure Hose (Metal Surround)

高壓尼龍軟管 (FHCH型)  
High-Pressure nylon tube

▲容許壓力Acceptable pressure: 40kg/cm<sup>2</sup>

▲材質Materials: 耐油橡膠 Rubber

▲管端Tube: 銅管copper



6mm



4mm

型式 Model	長度 Length L ± 5mm	外徑 Dia. d1	外徑 Dia. d3	外徑 Dia. d2	最高壓力 Max. pressure
FHC-401H	100	4	M8x1	12	100kg/cm <sup>2</sup>
FHC-402H	200				
FHC-403H	300				
FHC-601H	100	6	M10x1	14	
FHC-602H	200				
FHC-603H	300				

▲右記尺寸除外，尺寸長度可訂作。

The length of flexible hose can be made by customer's requirement.

管類 Pipe

銅管  
Copper pipe



鋁管  
Aluminum pipe



尼龍管  
Nylon pipe



單位Unit: mm

種類 Item	記號 Model	管徑 Pipe dia
銅管 Copper pipe	PC	4, 6, 8, 10, 12
鋁管 Aluminum pipe	PA	4, 6, 8, 10, 12
尼龍管 Nylon pipe	PN	4, 6, 8, 10, 12

過濾器 Filter

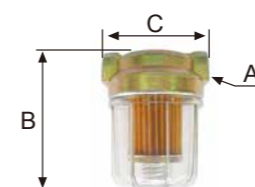

單位Unit: mm

型式 Model	A	B	C	過濾密度 Filter the desity
YD-1	1/8PT	70	50	100目
YD-2	1/4PT	120	60	100目

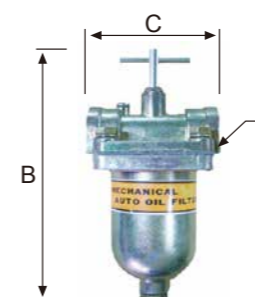

單位Unit: mm

型式 Model	A	B	C	過濾密度 Filter the desity
YD-3	3/8PT	160	75	100目
YD-4	1/2PT	160	75	100目
YD-6	3/4PT	200	90	100目
YD-8	1"	270	120	100目

套管帽 Sleeve Unit

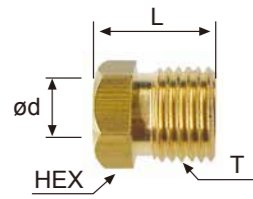

單位Unit: mm

型式 Model	管徑 DIA	ød	L	T	HEX
PA-4	ø4	4.1	12	M8x1.0	8
PA-6	ø6	6.1	12.5	M10x1.0	10
PA-8	ø8	8.2	14	M14x1.5	14
PA-10	ø10	10.2	15	M16x1.5	17
PA-12	ø12	12.2	16	M18x1.5	19

套管 Sleeve

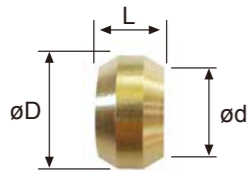

單位Unit: mm

型式 Model	管徑 DIA	ød	øD	L
PB-4	ø4	4.1	6	4.5
PB-6	ø6	6.1	8	4.5
PB-8	ø8	8.1	10	7
PB-10	ø10	10.1	12	8
PB-12	ø12	12.1	14	9

銅接頭 Connector

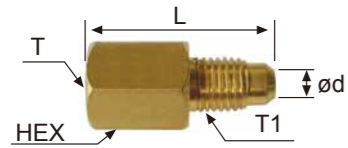

單位Unit: mm

型式 Model	管徑 DIA	ød	L	T	T1	HEX
PD-101	ø4	3	23	PS1/8	M8x1.0	12
PD-110	ø6	3	23	M10x1.0	M8x1.0	12

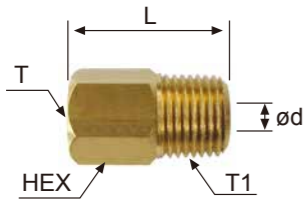

型式 Model	管徑 DIA	ød	L	T	T1	HEX
PD-401	ø4	3	18	M8x1.0	PT 1/8	10
PD-402	ø4	5	18	M8x1.0	PT 1/4	14
PD-601	ø6	4	18	M10x1.0	PT 1/8	12
PD-602	ø6	5	18	M10x1.0	PT 1/4	14
PD-802	8	6	26	M14x1.5	PT 1/4	17
PD-803	8	8	26	M14x1.5	PT 3/8	17
PD-1002	10	7	29	M16x1.5	PT 1/4	19
PD-1003	10	8	29	M16x1.5	PT 3/8	19
PD-1202	12	10	32	M18x1.5	PT 1/4	21
PD-1203	12	10	32	M18x1.5	PT 3/8	21

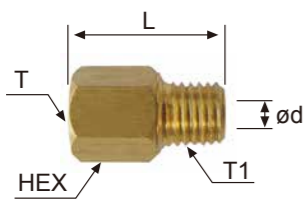

型式 Model	管徑 DIA	ød	L	T	T1	HEX
PD-406	ø4	3	20	M8x1.0	M6x1.0	12
PD-408	ø4	3	20	M8x1.0	M8x1.0	14
PD-410	ø4	3	23	M8x1.0	M10x1.0	14
PD-610	ø6	4	24	M10x1.0	M10x1.0	17
PD-612	ø6	4	24	M10x1.0	M12x1.0	17
PD-812	ø8	6	30	M14x1.5	M12x1.0	19

快速接頭 Quick Joint

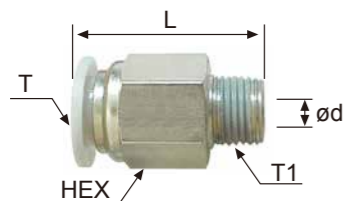

型式 Model	管徑 DIA	ød	L	T1	HEX
APC-401	4	3	23	PT1/8	13
APC-402	4	3	23	PT1/4	13
APC-601	6	5	25	PT1/8	16
APC-602	6	5	25	PT1/4	16
APC-801	8	7	27	PT1/8	18
APC-802	8	7	27	PT1/4	18



型式 Model	管徑 DIA	ød	T1(外牙)
APL-401	4	3	PT1/8
APL-402	4	3	PT1/4
APL-601	6	5	PT1/8
APL-602	6	5	PT1/4
APL-801	8	7	PT1/8
APL-802	8	7	PT1/4

銅接頭 Connector

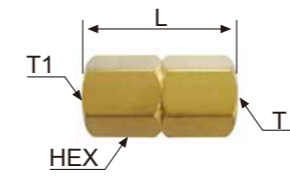

單位Unit: mm

型式 Model	管徑 DIA	L	T	T1	HEX
PN-4	ø4	23	M8x1.0	PT 1/8	12
PN-6	ø6	23	M10x1.0	PT 1/8	12
PN-8	ø8	23	M14x1.5	PT 1/4	17
PN-10	ø10	23	M16x1.5	PT 1/4	19
PN-12	ø12	23	M18x1.5	PT 3/8	21

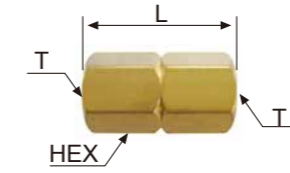

型式 Model	管徑 DIA	L	T	HEX
PM-4	ø4	23	M8x1.0	10
PM-6	ø6	23	M10x1.0	12
PM-8	ø8	33	M14x1.5	17
PM-10	ø10	36	M16x1.5	19
PM-12	ø12	39	M18x1.5	21

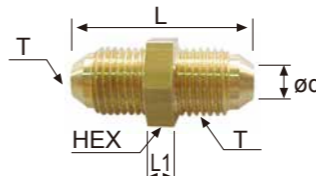

型式 Model	管徑 DIA	ød	L	L1	T	HEX
PQ-8	-	3	26	4	M8x1.0	10
PQ-10	-	4	26	4	M10x1.0	12
PQ-14	-	6	29	5	M14x1.5	17
PQ-16	-	8	29	5	M16x1.5	19
PQ-18	-	10	32	6	M18x1.5	21

銅接頭 Connector

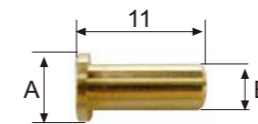

單位Unit: mm

型式 Model	A m/m	B m/m
PI-4	3.8	2.1 / 2.5
PI-6	5.8	4.1
PI-8	7.8	6

塞頭 Plug

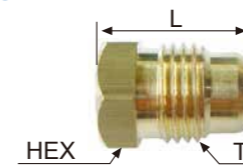

單位Unit: mm

型式 Model	管徑 DIA	L	T	HEX
PG-004	-	14.5	M8x1.0	8
PG-006	-	15	M10x1.0	10
PG-008	-	23	M14x1.5	14
PG-010	-	26	M16x1.5	17

平面直角接頭 Connector

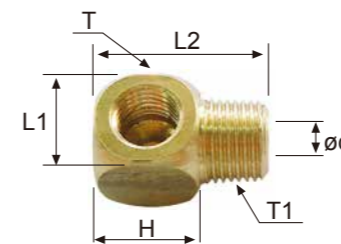

單位Unit: mm

型式 Model	管徑 DIA	ød	L1	L2	T	T1	H
PH1-1	-	2.5	12	20	1/8 PT	PT 1/8	12
PH1-8	-	2	12	20	1/8 PT	M8x1.0	12
PH4-1	ø4	2	12	20	M8x1.0	PT 1/8	12
PH4-2	ø4	2	14	22	M8x1.0	PT 1/4	14
PH4-6	ø4	2	12	20	M8x1.0	M6x1	12
PH4-8	ø4	2	12	20	M8x1.0	M8x1	12
PH6-1	ø6	3	14	22	M10x1.0	PT 1/8	14
PH6-2	ø6	3	14	24	M10x1.0	PT 1/4	14

直角接頭 Right Angle Connector

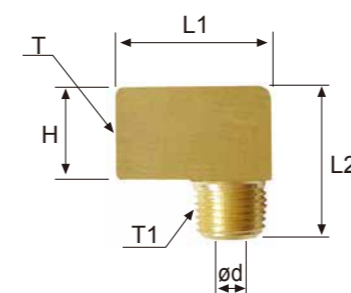

單位Unit: mm

型式 Model	管徑 DIA	ød	L1	L2	T	T1	H
PH-401	4	3	18	18	M8x1.0	PT 1/8	10
PH-402	4	3	18	18	M8x1.0	PT 1/4	14
PH-406	4	2	18	18	M8x1.0	M6xx1.0	10
PH-408	4	2	18	18	M8x1.0	M8x1.0	10
PH-410	4	3	18	18	M8x1.0	M10x1.0	10
PH-601	6	4	20	20	M10x1.0	PT 1/8	12
PH-602	6	4	20	20	M10x1.0	PT 1/4	14
PH-802	8	6	27	27	M14x1.5	PT 1/4	17
PH-803	8	6	27	27	M14x1.5	PT 3/8	17
PH-1002	10	8	30	30	M16x1.5	PT 1/4	19
PH-1003	10	8	30	30	M16x1.5	PT 3/8	19
PH-1202	12	10	33	34	M18x1.5	PT 1/4	21
PH-1203	12	10	33	34	M18x1.5	PT 3/8	21