

# Product Guide

TO emBEDded OR NOT TO emBEDded



EtherCAT



## Industrial Embedded Solutions



SBC



Panel PC



Box PC



Storage



QEC EtherCAT Solution

# About ICOP

**ICOP Technology**, established in 1997, is the world's leading manufacturer of industrial embedded solutions. Headquartered in Taipei, Taiwan and subsidiaries around the globe as well as worldwide distributors demonstrates ICOP's global commitment for long term and local support.

ICOP constantly strives to provide highest quality and reliability, extensive technical support, short lead times to reduced manufacturing costs and reasonable prices to meet its customers' expectations.

Strong know-how in the embedded field and extensive customer support helps ICOP to be recognized and selected by numerous well-known manufacturers and service providers from the industrial, medical, transportation, traffic management, agricultural field etc. just to mention a few.



↑ TAIPEI



↑ LOS ANGELES



↑ MEXICO CITY



↑ FRANKFURT

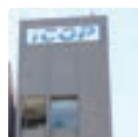

↑ TOKYO

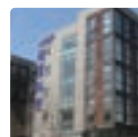

↑ BEI JING



↑ SHANG HAI



↑ XI AN

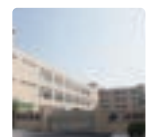

↑ SHEN ZHEN

# Table of Contents

● About ICOP	1
● Table of Contents	2
● ICOP Capability	3-4
● The Processors	5-6
● NX8MM Series	7-8
● Product Category	9
● Features	10
● SBC	
PC/104	11
3.5" SBC / Half-size SBC	12
Tiny SBC / ITX Board	13
ETX Module / EBM	14
SOM304 Module / SOM200 Module	15
DIP-128 Module / DIP-168 Module	16
● Panel PC	
Rugged PPC Series	17-18
Compact PPC Series	19
HMI-043T Series / Open Frame Series	20
● Box PC	
iBPC Series / EBOX-3362 Series	21
D-3362 Series / ICE-104 Series	22
EBOX-335xDX3 Series / EBOX-335xDX3-C2 Series	23
EBOX-336x Standard Series / EBOX-336x Special Series	24
EBOX-IMX8MM Series / DIN PC-336x Series	25
EBOX Apollo Lake Series / EBOX Braswell Series	26
● QEC-EtherCAT Solutions	27-30
● Flash Disk	31
● Peripheral	32
● Memo	33-34

# ICOP Capability

## ODM / OEM Service

Over 20 years of experience, ICOP has established a standardized ODM/OEM flow and provides over 100 types of customized products to our customers, and it occupies 50% of ICOP's sales.

- Project Time : 12 weeks from PO to prototype.

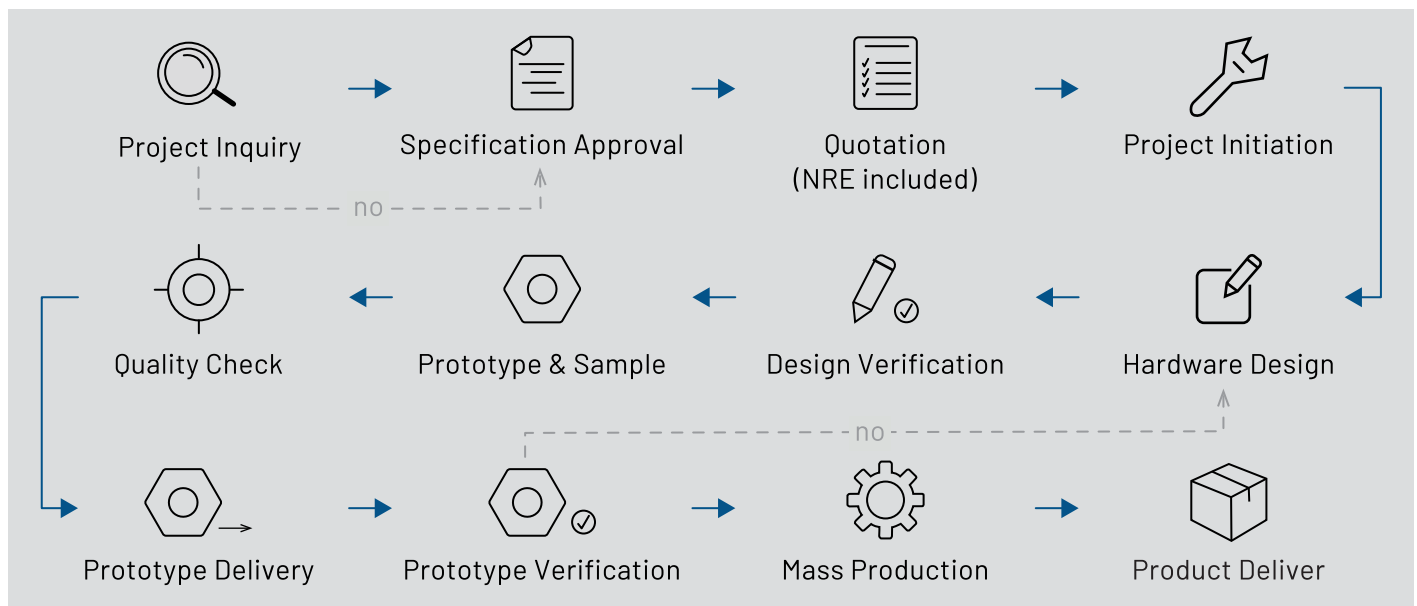

## Manufacture

- Production Line : 4 lines.

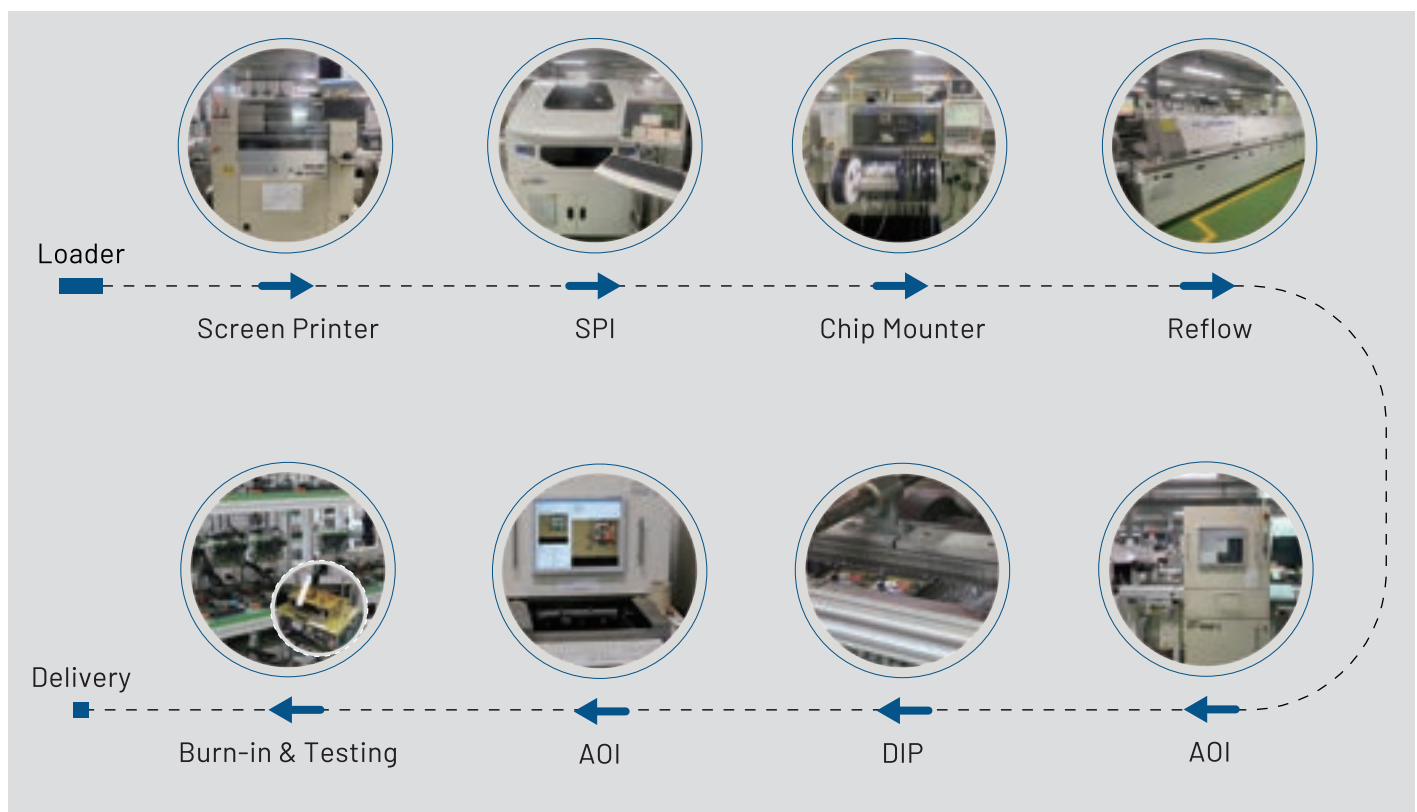

## Reliability Lab

In ICOP's Reliability Lab, we provide testing facilities below to test the reliability of all of our products.



- 1 **ESD Generator**  
IEC61000-4-2 EMC Test
- 2 **EFT Generator**  
Testing Capability: 1.5 kV
- 3 **Electrical Safety Compliance Analyzer**  
ACW, DCW, IR, GB tests ACW/DCW/IR/GB/high voltage endurance tests
- 4 **Programmable Temp. & Humidity Chamber**  
Temp.: -40 ~ +85°C  
Humidity: 10% ~ 98% RH
- 5 **EMI Compliance Testing**  
Test Grade : Class A/B  
Compliance with CE/FCC/VCCI Standard

## Mechanics & 3D Printed Sample Service



2.5D Optical Projector



Wire Cut EDM



CNC Milling Machine



3D Printed Sample Service



Coordinate Measuring Machine



Die Sink EDM



Laser Engraving Machine

## Conformal Coating & Underfill



### Conformal Coating

- The coating machine : Nordson SL-940
- The coating material : HumiSeal 1 B73 (acrylic type)



### Underfill

- The underfill machine : ASCENTEX ASG-Mini
- The underfill material : Zymet X2823-B



- Video -

# The Processors



**Elkhart Lake** is Intel's first IoT-optimized platform with best-in-class CPU/GPU performance to support IoT application requirements. It has a low TDP between 4.5 to 12 Watt TDP and up to 4 cores with Gen 11LP graphics and video encoding/decoding. For industrial and embedded applications, it has In-Band ECC, 3 x 2.5GbE TSN MACs, x12 configurable HSIO lanes and supports -40 to +85°C ambient temperatures.

Code Name	Elkhart Lake / Embedded			
Processor Number	x6211E	x6413E	x6425E	J6412
Product Collection	Atom	Atom	Atom	Celeron
Clock Speed	1.3GHz	1.5GHz	2.0GHz	2.0GHz
Burst Speed	3.0GHz	3.0GHz	3.0GHz	2.6GHz
# of Cores	2	4	4	4
OS Support	Windows 10/11, Windows 10/11 IoT, Linux			
TDP	6W	9W	12W	10W
Passmark Score	1695	4070	4884	4710



**Braswell** is the multicore system-on-a-chip based on Intel's latest microarchitecture and 14 nm process technology. It's built for designs that target entry-level 2-in-1 devices, laptops, desktops, and all-in-one PCs.

**Apollo Lake** is the multicore system-on-a-chip which empowers real-time computing in digital surveillance, new in-vehicle experiences, advancements in industrial and office automation, new solutions for retail and medical, and more. Utilizing Intel's industry-leading 14nm process technology.

Code Name	Braswell	Braswell	Braswell	Apollo Lake	Apollo Lake	Apollo Lake
Processor Number	N3710	N3160	x5-E8000	N4200	J3455	N3350
Product Collection	Pentium	Celeron	Atom	Pentium	Celeron	Celeron
Clock Speed	1.6GHz	1.6GHz	1.04GHz	1.10GHz	1.5GHz	1.10GHz
Burst Speed	2.56GHz	2.24GHz	2.0GHz	2.50GHz	2.3GHz	2.4GHz
# of Cores	4	4	4	4	4	2
OS Support	Windows 10, Windows 10 IoT, Linux					
Passmark Score	1864	1666	1568	2035	2108	879



**i.MX8M Mini** is NXP's first embedded multicore application processor built using advanced 14LPC FinFET process technology, providing more speed and improved power efficiency. Backed by NXP's product longevity program, the I.MX8M Mini family can be used in any general purpose industrial and IoT application.

Code Name	NXP I.MX8M Mini			
Core	Cortex-A53 1.6GHz			
# of Cores	4	2	4	2
GPU	GCNono Ultra for 3D, GC320 for 2D			
VPU	Decode 1080p60, H.264, H.264 / Encode 1080p60, H.264			
RAM, LPDDR4	1GB / 2GB / 4GB			
eMMC	8 ~ 64GB, SLC . MLC			
OS Support	Yocto Linux, Android			
Working Temp.	-40 to 85°C	-40 to 85°C	0 to 70°C	0 to 70°C

**DMP**

**Vortex86 DX series** includes the DX, DX2 and DX3. This family was originally designed for legacy x86 based applications that need traditional buses such as ISA, PCI, etc.; in the newest DX3 line, the system now utilizes an optional dual-core and also enriches the I/O interface, GPU, SATA and PCIe for legacy applications to take advantage of new technologies. The -40 to 85 °C wide temperature and 15+ year life cycle guarantee had consistently supported a variety of industrial applications for decades.



[ Vortex86DX3 Block Diagram ]

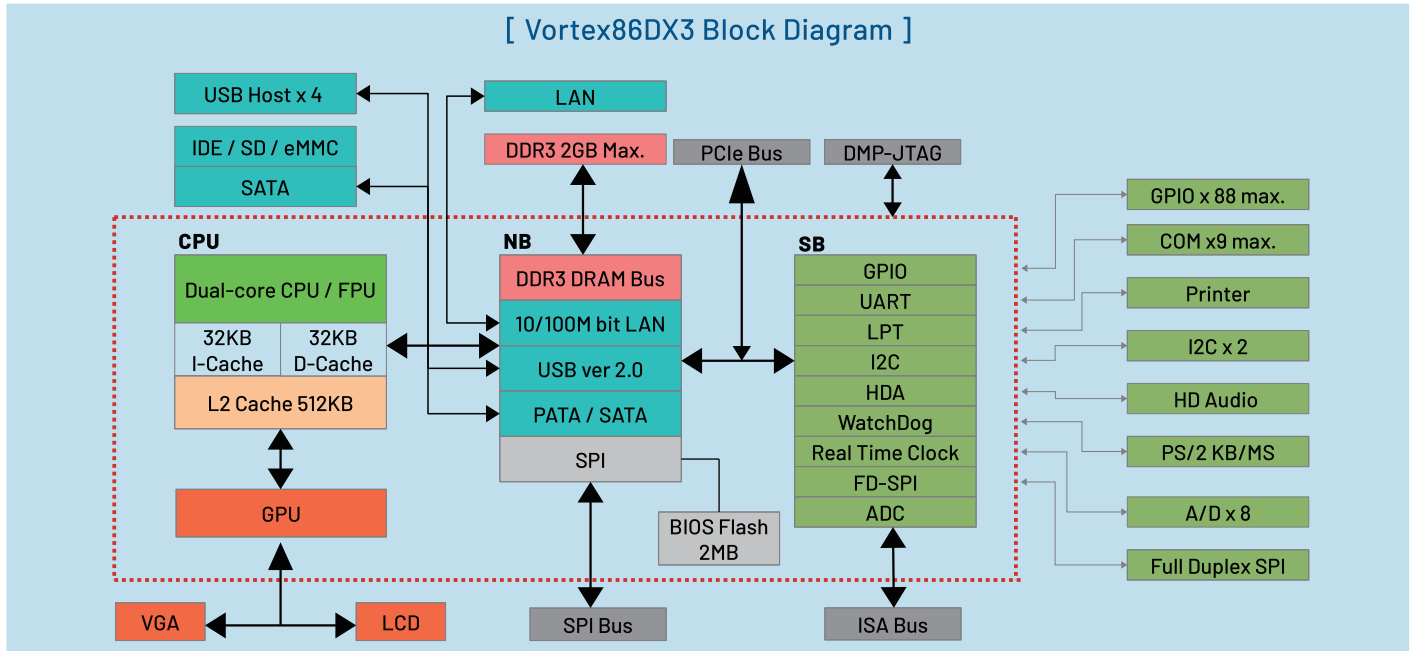

**DMP**

**Vortex86 EX series** includes the EX, EX2, and the upcoming EX3 in 2023. This tiny and low power consumption line of processors is equipped with a crossbar switch that allows for plenty of I/O for IoT, automation, and industrial applications. And for real-time applications, the current EX2 two-core CPU uses a Primary and Secondary core that can run different OS concurrently, making a system that can process in real-time while utilizing a dedicated CPU core.



[ Vortex86EX2 Block Diagram ]

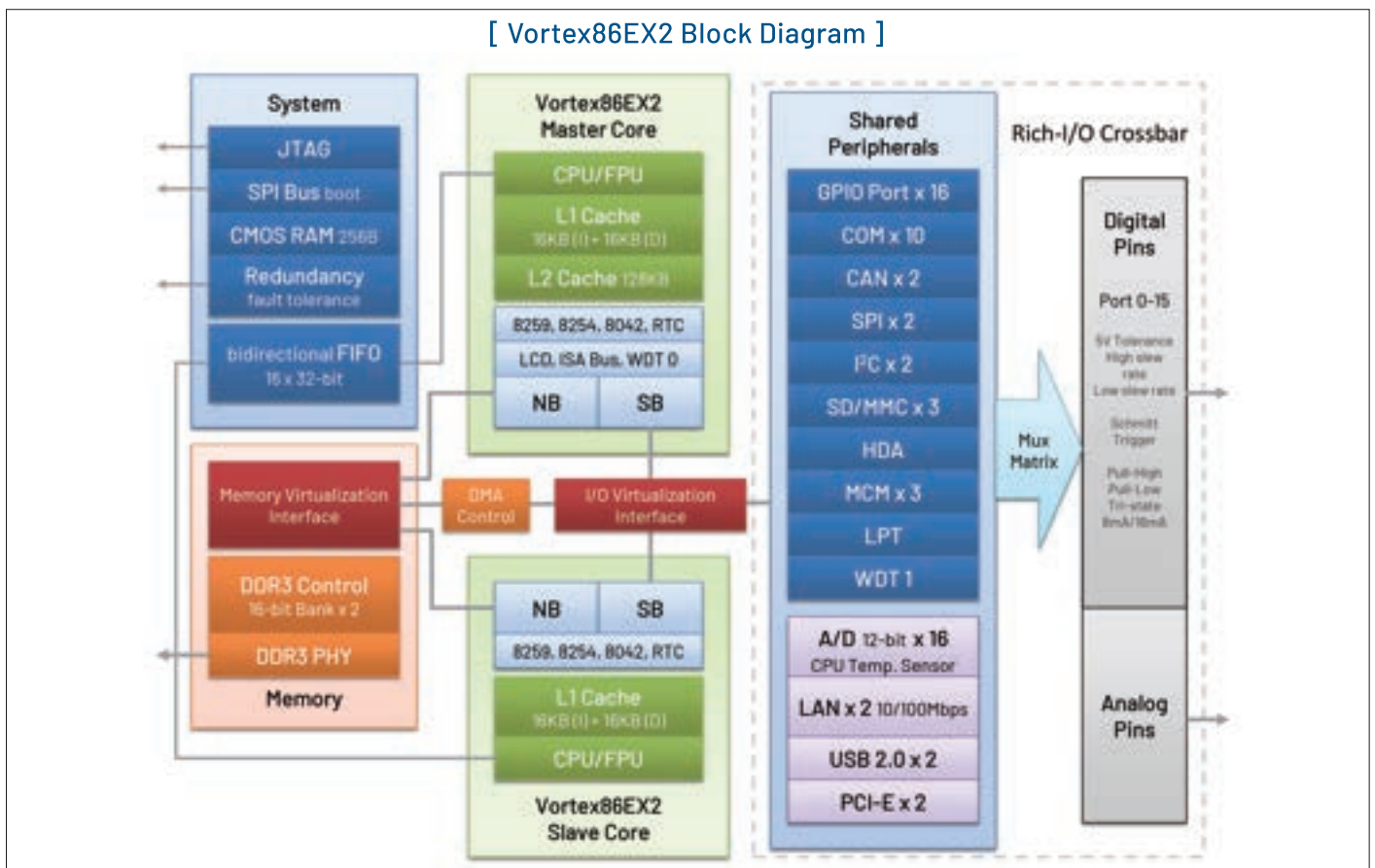

# NX8MM Series

NX8MM series is ICOP's new series based on i.MX8M MINI ARM based solutions.

We provides the products such as:

- System on Module - NX8MM-D168
- 3.5" Development board - NX8MM-35
- BOX PC - EBOX-IMX8MM
- 9" Panel PC - PN8M-090T

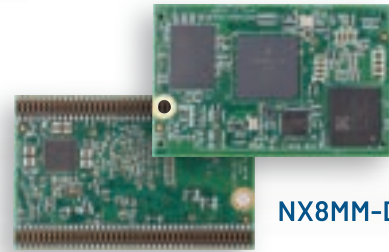

NX8MM-D168

## NX8MM-35

3.5" full function development board

Page 12



## PN8M-090T

9" IP65 front panel waterproof/dustproof PPC

Page 19



## EBOX-IMX8MM

115 x 115mm VESA compatible compact PC

Page 25



## What We Supports?



Software Support

android 

yocto  
PROJECT



One-station Engineering Service



ICOP Wiki



( <https://wiki.icop.com.tw> )

ICOP's wiki site and one-stop service offer comprehensive support including detailed recipes, demo images, and patches for Yocto Linux, Android, and other platforms.

# Solutions

# ARM



## Dimension

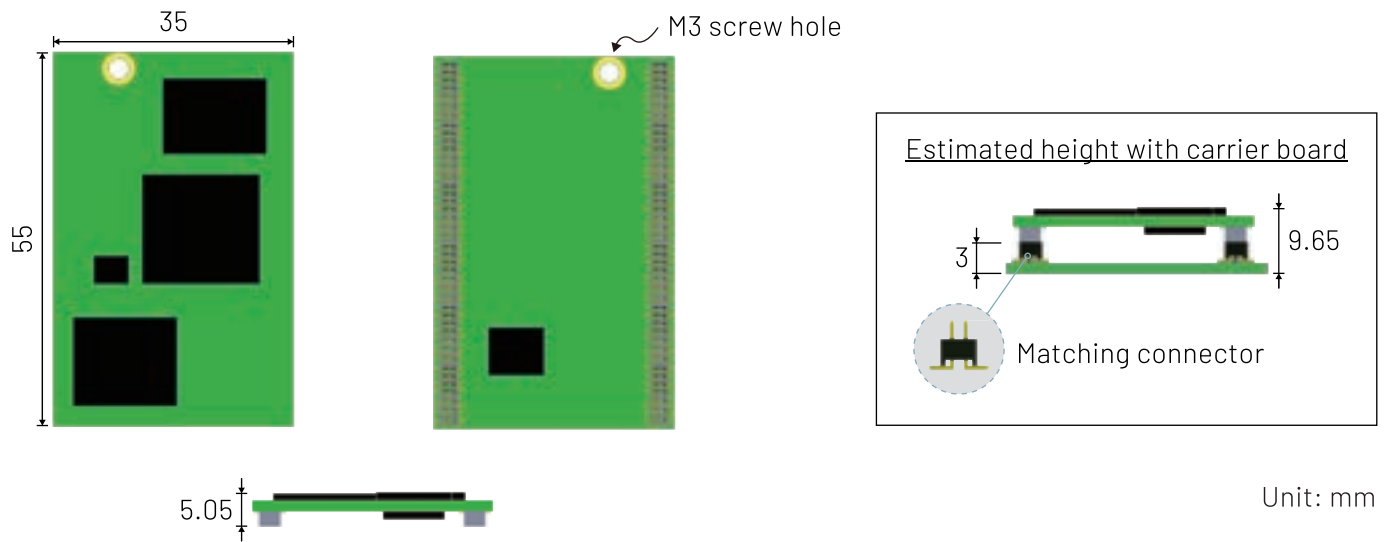

## Block Diagram

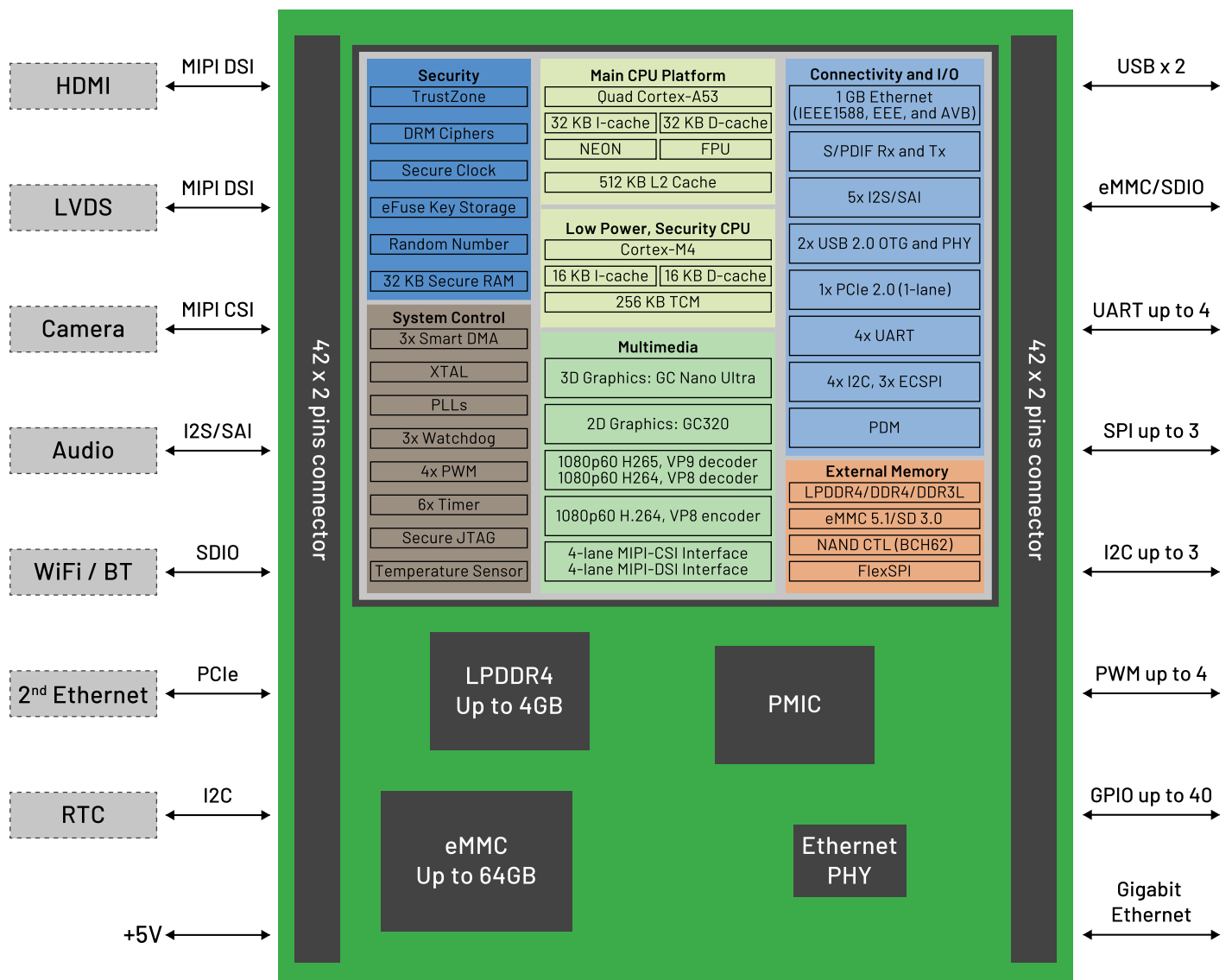

# Product Category



## Embedded SBC

Based on the DM&P family SoC core Technology, ICOP can provide several series of Industrial SBCs and SOMs for different industrial applications and customer needs.

[SoM-ICOP Proprietary](#) | [SoM-Standard](#) | [PC/104 SBC](#) | [3.5" SBC](#) | [Tiny SBC](#) | [Half-size SBC](#) | [ITX Board](#)



## Industrial Panel PC

Support for touch panel sizes including 4.3", 5.7", 6.5", 7", 8.4", 9", 10.4", and 15", the ICOP Industrial PPC series offers flexible I/O expansion and a ruggedized design.

[Panel PC Series](#) | [HMI Series](#) | [OpenFrame](#) | [LCD](#)



## Box PC

To satisfy the demands for different environments and applications, ICOP offers 3 series of Box PCs: ICE-104, iBPC and Mini PC.

[Mini PC](#) | [ICE-104](#) | [Embedded Barebone](#)



## QEC

The QEC device series, including the EtherCAT Master Device & Slave Controller, conform to standard EtherCAT protocol while promoting Arduino Style Programming and/or Block Coding.

[QEC-M](#) | [QEC-R](#) | [QEC-P](#)



## Flash Disk

ICOP's storage products offer a wider variety of interfaces for industrial embedded flash including SLC, MLC, and iSLC types. Storage sizes range from 512MB to 256GB.

[IDE DOM](#) | [SATA DOM](#) | [SATA-Slim](#) | [mSATA](#) | [M.2](#) | [Mini PCIe](#) | [CF cards](#)

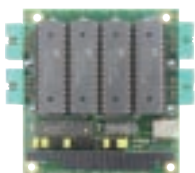

## Peripheral

ICOP's line of peripherals are external additions to our products that allow for easy development by our customers and include items such as the DC-to-DC power module, PC/104 48-bit/24-bit digital I/O card, PC/104 RS232 x4 port card, etc.

[Peripheral](#)



# Features



## Working Temperature

With strong know-how and experience in designing embedded boards and modules, ICOP provides -40°C to +85°C CPU board option for industrial applications stationed in harsh environments.



## Fanless Design

Fan malfunction and dust collection are failure points for critical applications. All ICOP products such as single board computer, touch panel computers, and small enclosure systems have a fanless standard by design.



## IP65 Waterproof

ICOP Touch Panel PC front panels are IP65 rated which meets demand for most applications and allows for specific outdoor and humid environments.



## Shock & Vibration

All ICOP products feature excellent robustness; and with an ICOP solution, your applications can be deployed in harsh environments without worry. Shock & Vibration certifications are available for systems and panels online.

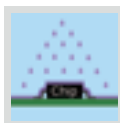

## Coating Service

In-house conformal coating services are an option that provides additional protection for boards against a variety of hazards such as moisture, dust, salt, chemicals, temperature changes, and mechanical abrasions.

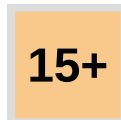

## 15+ Year Life Cycle

With extensive ERP knowledge and support by group member DMP Electronics, ICOP can maintain and commits to providing long-life products by supplying the product for 15 years from launch.

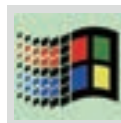

## Variety of OS Support

The demand for legacy OS always exist for its high stability. ICOP is currently the only vendor with the ability to offer support for legacy DOS, Windows CE, and Windows 7/10. Mainstream Linux distributions and Real Time Operating Systems are also supported.

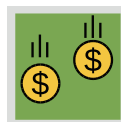

## Budget

By taking advantage of the Vortex86 System-on-Chip which builds in most of the required I/O functions without using extra I/O ICs, ICOP is able to provide low BOM item products to avoid shortages and providing products at budgetary price points.



## ODM Service

By leveraging ICOP's design, manufacturing and production capability, 3 prototype samples can usually be provided within 8 weeks for customer's test after product's specifications and BOM (Bill of Materials) are confirmed by ICOP and the customer.

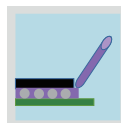

## Underfill Service

In-house underfill service options provide protection for boards against dropping, scrolling, vibration, and collision during delivery and operation.



# PC/104

- **CPU** : Intel Braswell Family / DMP Vortex86
- **Operating Temp.** : -40 ~ +85°C Max.
- **Features** : 16-bit full ISA support
  - Fanless
  - 10 years life cycle



■ **Size** : 90 x 96mm



■ **Size** : 116 x 96mm

Part No.	CPU	RAM	Storage	I/O
IBW-6954	Pentium® N3710 Atom® x5-E8000 Celeron® N3160	4GB	SATA	4S/4U/GLAN/LPT/I <sup>2</sup> C/Audio/ mPCIe/16GPIO/HDMI/VGA/LVDS
VEX2-6454-2C4INE	Vortex86EX2-600MHz	1GB	Micro SD/eMMC	2S/2U/LAN/LPT/Audio/mPCIe/ VGA/LCD/LVDS
VEX2-6454-4C4NE	Vortex86EX2-600MHz	1GB	Micro SD/eMMC	4S/2U/LAN/LPT/Audio/mPCIe/ 16GPIO/VGA/LCD/LVDS
VDX3-6754-V2-2G	Vortex86DX3-1GHz	2GB	SATA	4S/2U/LAN/LPT/Audio/16GPIO/ VGA/LCD/LVDS
VDX3-6754-V2-2C-2G	Vortex86DX3-Dual Core -1GHz	2GB	SATA	4S/2U/LAN/LPT/Audio/16GPIO/ VGA/LCD/LVDS
VDX3-6754S-V2	Vortex86DX3-600MHz	256MB	SATA	4S/2U/LAN/LPT/16GPIO/ VGA/LCD/LVDS
VDX3-6755-2G	Vortex86DX3-1GHz	2GB	SATA	3S (isolated)/2U/GLAN/LAN/ CAN(Opt.)/VGA/LVDS
VDX3-6755-2C-2G	Vortex86DX3-Dual Core -1GHz	2GB	SATA	3S (isolated)/2U/GLAN/LAN/ CAN(Opt.)/VGA/LVDS
NAD11-103-SD	Vortex86DX2-800MHz	256MB	SD	4S/4U/LAN/I <sup>2</sup> C/VGA/LCD/LVDS

■ S=RS232/422/485; U=USB; GLAN=GigaLan; LPT=Printer; mPCIe=miniPCIe

## 3.5" SBC

- **CPU** : Intel Braswell Family / Intel Apollo Lake Family / DMP Vortex86
- **Operating Temp.** : -40 ~ +85°C Max.
- **Size** : 102 x 146mm
- **Features** : 10 COM  
Fanless  
10 years life cycle

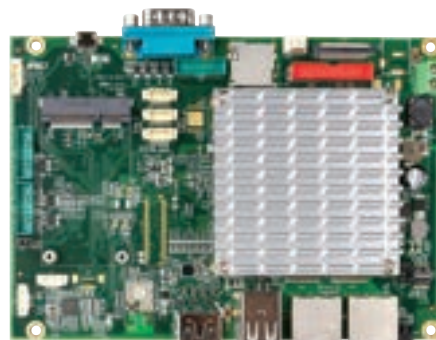

Part No.	CPU	RAM	Storage	I/O
NX8MM-35	NXP I.MX8M MINI Quad Core 1.6GHz	2GB/4GB Max.	eMMC/SD	3S/3U/HDMI(MIPI-DSI)/MIPI-CSI/ Audio/mPCIe/GLAN/WIFI/BT
IBW-35	Pentium® N3710 Atom® x5-E8000 Celeron® N3160	4GB	mSATA/SATA	4S/6U/2GLAN/I²C/Audio/mPCIe/ 16GPIO/HDMI/VGA/LVDS
APL-35	Celeron® N3350 Pentium® N4200 Celeron® J3455	8GB Max.	M.2 SATA/SATA	6S/6U/2GLAN/I²C/Audio/mPCIe/ 8GPIO/2DP/eDP
VEX2-6427-10C4VNE	Vortex86EX2-600MHz	1GB	Micro SD/SD/ eMMC	10S/4U/LAN/2CAN/2I²C/Audio/ mPCIe/VGA/LCD/LVDS
VDX3-6726-V2-2G	Vortex86DX3-1GHz	2GB	SATA	4S/4U/2GLAN/LAN/LPT/ Audio/16GPIO/VGA/LVDS
VEX-6225-43VE	Vortex86EX-400MHz	512MB	Micro SD/SATA	2S/2U/LAN/CAN/I²C/ mPCIe/8ADC/VGA/LCD

■ S=RS232/422/485; U=USB; GLAN=GigaLan; LPT=Printer; mPCIe=miniPCIe

## Half-size SBC

- **CPU** : DMP Vortex86
- **Operating Temp.** : -40 ~ +85°C Max.
- **Size** : 187 x 122mm
- **Features** : 16-bit full ISA support  
PCI support  
Fanless  
10 years life cycle

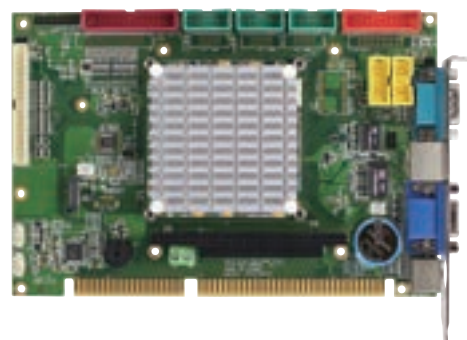

Part No.	CPU	RAM	Storage	I/O
VDX3-6724-V2-2G	Vortex86DX3-1GHz	2GB	SATA	4S/4U/GLAN/LAN/LPT/Audio/ 16GPIO/VGA/LCD/LVDS
VDX3-6724-V2-CF-2G	Vortex86DX3-1GHz	2GB	CF/SATA	4S/4U/GLAN/LAN/Audio/ VGA/LCD/LVDS
VDX3-PCI-7S5E	Vortex86DX3-1GHz	2GB	IDE/CF/SATA	2S/2U/GLAN/Audio/ VGA/LVDS
VDX3-PCI-7S4E	Vortex86DX3-1GHz	1GB	IDE/CF/SATA	2S/2U/GLAN/Audio/ VGA/LVDS
VDX-6324RD	Vortex86DX-800MHz	512MB Max.	Micro SD/SATA	4S/4U/LAN/LPT/16GPIO/ VGA/LCD

■ S=RS232/422/485; U=USB; GLAN=GigaLan; LPT=Printer; mPCIe=miniPCIe

# Tiny SBC

- CPU : DMP Vortex86
- Operating Temp. : -40 ~ +85°C Max.
- Size : 100 x 66mm
- Features : Compact design  
Fanless  
10 years life cycle

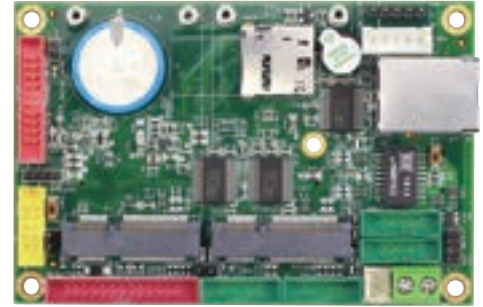

Part No.	CPU	RAM	Storage	I/O
VEX2-6415-4C4NE	Vortex86EX2-600MHz	1GB	Micro SD/eMMC	4S/2U/2LAN/LPT/Audio/ 2mPCIe/16GPIO
VEX2-6415-4C3NE	Vortex86EX2-600MHz	512MB	Micro SD/eMMC	4S/2U/2LAN/LPT/Audio/ 2mPCIe/16GPIO
VDX2-6518-1G-SD	Vortex86DX2-800MHz	1GB	SD	4S/2U/LAN/LPT/8GPIO/ VGA/LVDS
VDX-6318RD	Vortex86DX-800MHz	512MB Max.	IDE	4S/4U/LAN/Audio/32GPIO/ VGA/LCD
VDX-6314RD	Vortex86DX-800MHz	512MB Max.	IDE	4S/2U/LAN/16GPIO/ VGA/LCD

■ S=RS232/422/485; U=USB; GLAN=GigaLan; LPT=Printer; mPCIe=miniPCIe

# ITX Board



**VDX3-EITX**

■ Size : 170 x 120mm



**VDX3-PITX**

■ Size : 100 x 72mm

Part No.	CPU	RAM	Storage	I/O
APL-PITX	Celeron® N3350 Pentium® N4200	8GB Max.	M.2 SATA/SATA	2S/4U/GLAN/Audio/mPCIe/ 8GPIO/HDMI/LVDS
VDX3-PITX-7S5E1	Vortex86DX3-1GHz	2GB	Micro SD/SATA	4U/LAN/Audio/16GPIO/ 8ADC/VGA
VDX3-EITX-7S5E1	Vortex86DX3-1GHz	2GB	CF/SATA	3S/6U/GLAN/LAN/CAN/Audio/ VGA/LVDS

■ S=RS232/422/485; U=USB; GLAN=GigaLan; LPT=Printer; mPCIe=miniPCIe

# ETX Module | ETX®

- **CPU** : DMP Vortex86
- **Operating Temp.** : -40 ~ +85°C Max.
- **Size** : 95 x 144mm
- **Features** : 16-bit full ISA support  
PCI support  
Fanless  
10 years life cycle



Part No.	CPU	RAM	Onboard Storage	I/O
VDX3-ETX-74IE-V2	Vortex86DX3-1GHz	1GB	SATA	2S/4U/LAN/I <sup>2</sup> C/Audio/IDE/VGA/LCD
VDX3-ETX-74LE-V2	Vortex86DX3-1GHz	1GB	SATA	2S/4U/LAN/LPT/I <sup>2</sup> C/Audio/VGA/LCD
VDX3-ETX-75IE-V2	Vortex86DX3-1GHz	2GB	SATA	2S/4U/LAN/I <sup>2</sup> C/Audio/IDE/VGA/LCD
VDX3-ETX-75LE-V2	Vortex86DX3-1GHz	2GB	SATA	2S/4U/LAN/LPT/I <sup>2</sup> C/Audio/VGA/LCD

■ S=RS232/422/485; U=USB; GLAN=GigaLan; LPT=Printer; mPCIe=miniPCIe

# EBM

- **CPU** : Intel Braswell Family / Intel Apollo Lake Family
- **Operating Temp.** : 0 ~ +60°C Max.
- **Size** : 101.6 x 111.5mm
- **Features** : Fanless  
10 years life cycle



Part No.	CPU	RAM	Storage	I/O
APL-U	Celeron® N3350 Celeron® J3455	8GB Max.	M.2 SATA/SATA	1S/5U/2GLAN/Audio/2mPCIe/8GPIO/HDMI/VGA
IBW-U	Pentium® N3710 Atom® x5-E8000 Celeron® N3160	8GB Max.	Micro SD/SATA	2S/4U/2GLAN/Audio/M.2 2230 E-key/HDMI

■ S=RS232/422/485; U=USB; GLAN=GigaLan; LPT=Printer; mPCIe=miniPCIe

# SOM304 Module

- CPU : DMP Vortex86
- Operating Temp. : -40 ~ +85°C Max.
- Size : 70 x 70mm
- Features : 16-bit full ISA support  
PCIe support  
Fanless  
10 years life cycle



Part No.	CPU	RAM	Onboard Storage	I/O
SOM304D375EINE1-HS	Vortex86DX3-1GHz	2GB	N/A	4U/LAN/2PCIe/SATA/ISA/VGA/ 11 Configurable I/O Ports/LCD

■ S=RS232/422/485; U=USB; GLAN=GigaLan; LPT=Printer; mPCIe=miniPCIe

# SOM200 Module

- CPU : DMP Vortex86EX
- Operating Temp. : -40 ~ +85°C Max.
- Size : 52 x 52mm
- Features : Maximum 10 configurable I/O ports  
16-bit x-ISA support  
PCIe support  
Fanless  
10 years life cycle



Part No.	CPU	RAM	Onboard Storage	I/O
SOM200EX43VGNE1	Vortex86EX-400MHz	512MB	N/A	2S/LAN/8ADC/SATA/ 10 Configurable I/O Ports/VGA
SOM200EX43EGNE1	Vortex86EX-400MHz	512MB	N/A	2U/LAN/8ADC/PCIe/SATA/ 10 Configurable I/O Ports

■ S=RS232/422/485; U=USB; GLAN=GigaLan; LPT=Printer; mPCIe=miniPCIe

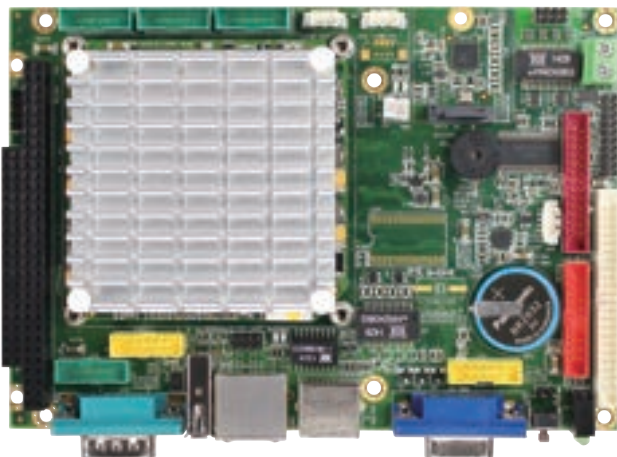

VDX3-6726

- Development board for [SOM304D3](#)



VEX-6225

- Development board for [SOM200EX](#)



## DIP-128 Module

- CPU : DMP Vortex86EX
- Operating Temp. : -40 ~ +85°C Max.
- Size : 45 x 28mm
- Features : Maximum 10 configurable I/O ports  
16-bit x-ISA support  
PCIe support  
Fanless  
10 years life cycle



Part No.	CPU	RAM	Onboard Storage	I/O
VEX-SOM	Vortex86EX-400MHz	128MB	N/A	2U/LAN/8ADC/PCIe/SATA/ 10 Configurable I/O Ports
VEX-SOM-512	Vortex86EX-400MHz	512MB	N/A	2U/LAN/8ADC/PCIe/SATA/ 10 Configurable I/O Ports

■ S=RS232/422/485; U=USB; GLAN=GigaLan; LPT=Printer; mPCIe=miniPCIe

## DIP-168 Module

- CPU : NXP i.MX8M Mini / DMP Vortex86EX2
- Operating Temp. : -40 ~ +85°C Max.
- Size : 55 x 35mm
- Features : Maximum 15 configurable I/O ports  
16-bit full ISA support  
PCIe support  
Fanless  
10 years life cycle



VEX2-DIP-168



N8MM-D168

Part No.	CPU	RAM	Onboard Storage	I/O
NX8MM-D168	NXP i.MX 8M Mini Quad Core 1.6GHz	2GB Max.	Micro SD	4S/2U/GLAN/MIPI-CSI/4PWM/3I <sup>2</sup> C /3SPI/3I <sup>2</sup> S/20GPIO/PCIe/MIPI-DSI
VEX2-DIP-168-4ME1	Vortex86EX2-600MHz	1GB	Micro SD	2U/LAN/8ADC/2PCIe/ 15 Configurable I/O Ports
VEX2-DIP-168-4EE1	Vortex86EX2-600MHz	1GB	4GB eMMC	2U/LAN/8ADC/2PCIe/ 15 Configurable I/O Ports

■ S=RS232/422/485; U=USB; GLAN=GigaLan; LPT=Printer; mPCIe=miniPCIe

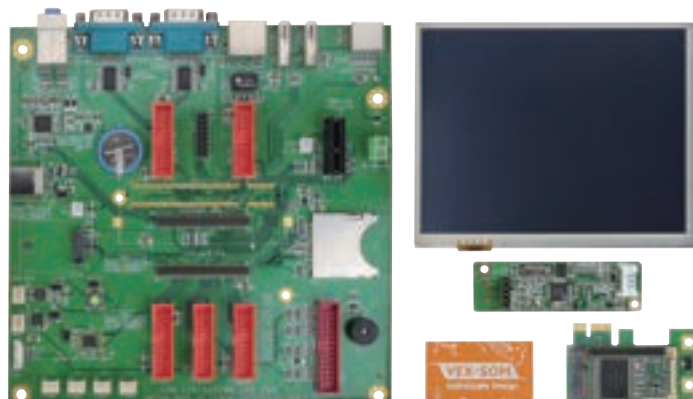

### VEX-IOT-DEV

- Development kit for [VEX-SOM](#)



### VEX2-6427

- Development board for [VEX2-DIP-168](#)

# Rugged PPC Series

- Features :** Support x86 platform of DMP Vortex86 Processors.  
 Different size of LCD and Touch panel support for 9", 10.4" and 15".  
 Wide power requirement, +12VDC ~ +24VDC.  
 Flexible I/O expansion.  
 IP65 Front Panel Protection.  
 Metal and Fanless Design & VESA and Panel Mount Support.



Model Name	PPC-090T	PPC-104T	PPC-150T	PPC-150P
Display Size	9" WSVGA	10.4" SVGA	15" XGA	
Max. Resolution	1024 x 600	800 x 600	1024 x 768	
Luminance (cd/m <sup>2</sup> )	300	500	350	
Touch Screen	Analog Resistive/ Capacitive Touch Panel	Analog Resistive		Capacitive Touch Panel
CPU	Vortex86DX2-933MHz Vortex86DX3-1GHz (Dual core)			
System Memory	1GB/2GB			
I/O	2S/3U/LAN/GLAN/Audio			
Storage	CF Card/STAT SLIM/2GB Nand Flash Onboard			
Expansion I/O	PoE/COM x5/COM x3 + 16bit GPIO			
Power Requirement	+12VDC ~ 24VDC			
Operating Temp.	0 ~ 50°C / -20 ~ +60°C			
Dimension (WxHxD mm)	242 x 156.5 x 44	273.4 x 219.8 x 49	354.9 x 280.4 x 55	354.9 x 280.9 x 54.9
Certificate	CE, FCC, VCCI, Shock, Vibration, IP65 (Front Panel)			

- S=RS232/422/485; U=USB; GLAN=GigaLan; LPT=Printer; mPCIe=miniPCIe

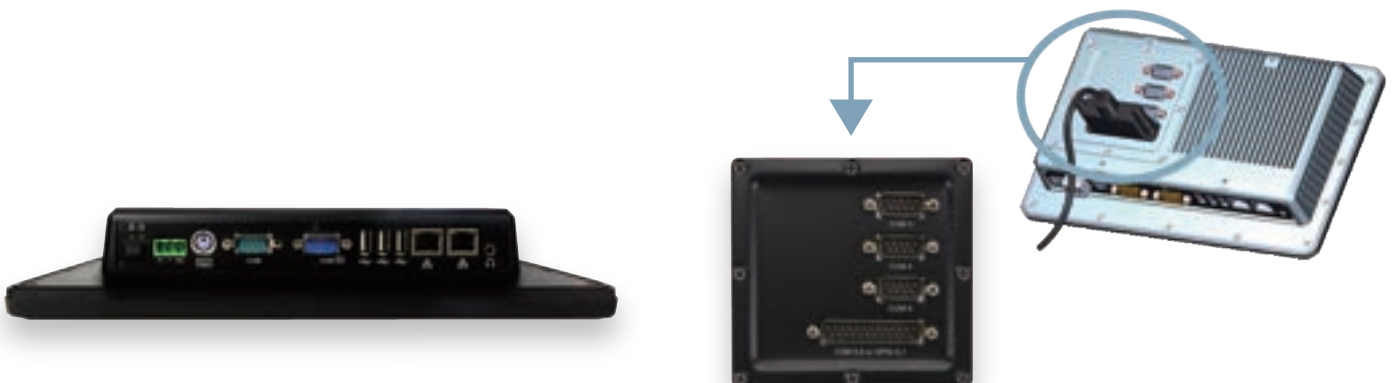

- Expansion I/O Ports  
with Custom Design

# Rugged PPC Series

- Features :** Support x86 platform of Intel® Processor.  
 Different size of LCD and Touch panel support for 9", 10.4" and 15".  
 IP65 Front Panel Protection.  
 Metal and Fanless Design.  
 VESA and Panel Mount Support.



Model Name	PPC-090T-EHL	PPC-104T-EHL	PPC-150T-EHL	PPC-150P-EHL
Display Size	9" WSVGA	10.4" SVGA	15" XGA	
Max. Resolution	1024 x 600	800 x 600	1024 x 768	
Luminance (cd/m <sup>2</sup> )	300	500	350	
Touch Screen	Analog Resistive/ Capacitive Touch Panel	Analog Resistive		Capacitive Touch Panel
CPU	Intel® Elkhart Lake J6412 Processor (Quad Core 2.0GHz)			
System Memory	8GB / 16GB / 32GB			
I/O	2S/USB3.1 x3/USB2.0 x3/2.5GbE x2 /HDMI x2/Audio			
Storage	M.2 M-key (2242/2280) PCIe Gen.3 x2/SATA Interface Support NVME			
Expansion I/O	M.2 B-key (3024) USB3.1/USB2.0 Interface & M.2 E-key (2230) USB2.0/PCIe Gen.3 x1 Interface			
Power Requirement	+12VDC ~ 24VDC			
Operating Temp.	0 ~ +60°C			
Dimension (WxHxD mm)	242.02 x 156.52 x 50.55	273.44 x 219.84 x 56.05	354.84 x 280.84 x 61.55	359.63 x 282.98 x 61.54
Sample & Certificate	CE, UKCA, FCC, VCCI, Shock, Vibration, IP65 (Front Panel)(Avaliable on Q3, 2023)			

Model Name	PPC-090T-APL	PPC-104T-APL	PPC-150T-APL	PPC-150P-APL
Display Size	9" WSVGA	10.4" SVGA	15" XGA	
Max. Resolution	1024 x 600	800 x 600	1024 x 768	
Luminance (cd/m <sup>2</sup> )	300	500	350	
Touch Screen	Analog Resistive / Capacitive Touch Panel	Analog Resistive		Capacitive Touch Panel
CPU	Intel® Pentium® N4200 (Quad) Intel® Celeron® N3350 (Dual)			
System Memory	4GB/8GB			
I/O	2S/3U/LAN/GLAN/Audio			
Storage	M.2 2242 SATA M-key/2.5" SATA HDD / SSD			
Expansion I/O	mPCIe Slot x1/HDMI 1.4 (as DUAL Display)			
Power Requirement	+12VDC			
Operating Temp.	0 ~ +60°C			
Dimension (WxHxD mm)	242 x 156.5 x 50.6	273.4 x 219.8 x 52.5	354.9 x 280.9 x 58	359.6 x 283 x 57.9
Certificate	CE, FCC, VCCI, Shock, Vibration, IP65 (Front Panel)			

■ S=RS232/422/485; U=USB; GLAN=GigaLan; LPT=Printer; mPCIe=miniPCIe

# Compact PPC Series

- Features :** Support x86 platform of Intel® and DMP Vortex86 processors, and ARM platform of NXP iM8M Mini Cortex-A53 & Realtek RTD 1195 Cortex-A7 processors. Different size of LCD and Touch panel support for 5.7" and 9". IP65 Front Panel Protection for 9" Panel PC. Metal and Fanless Design. VESA and Panel Mount Support.



Model Name	PEX-057T	PEX-090T	PINT-090T-APL	PBSW-090T	PN8M-090T	PRTD-090T
	PDX2-057T	PDX2-090T				
	PDX3-057T	PDX3-090T				
Display Size	5.7" VGA		9" WSVGA			
Max. Resolution	640 x 480		1024 x 600			
Luminance (cd/m <sup>2</sup> )	500		300			
Touch Screen	Analog Resistive		Analog Resistive/Capacitive Touch Panel			Analog Resistive
CPU	Vortex86EXm-400MHz Vortex86DX2-933MHz Vortex86DX3-1GHz		Pentium® N4200 Celeron® N3350	Atom® x5-E8000 Pentium® N3710 Celeron® N3160	NXP i.MX8M Mini 1.6GHz Cortex-A53 (Quad)	Realtek RTD1195-1.2GHz Cortex-A7
System Memory	1GB/2GB		4GB/8GB	4GB	1GB/2GB/4GB	1GB/2GB
I/O	1S/2U/LAN/Audio		2S/3U/LAN/ GLAN/Audio	1S/2U/GLAN/Audio		1S/2U/LAN/ Audio
Storage	Miro SD Slot / CF Card/ 2GB Nand Flash Onboard		M.2 2242 SATA M-key		16GB eMMC, Micro SD Slot	8GB eMMC Onboard
Expansion I/O	N/A		mPCIe Slot x 1 HDMI 1.4 x 1	mPCIe Slot x 1		N/A
Power Requirement	+5VDC / +8 ~ +35VDC		+12VDC	+12 ~ +36VDC	+5VDC / +12 ~ +36VDC	+5VDC / +8 ~ +35VDC
Operating Temp.	0 ~ +50°C / -20 ~ +60°C		0 ~ +60°C	0 ~ +50°C / -20 ~ +60°C	0 ~ +60°C / -20 ~ +70°C	
Dimension (WxHxD mm)	152 x 112 x 33	236.6 x 146 x 35	236.3 x 146 x 44.5		236.6 x 146 x 35	
Certificate	CE, VCCI, FCC, Vibration		CE, VCCI, FCC, Shock, Vibration, IP65 (Front Panel)			

■ S=RS232/422/485; U=USB; GLAN=GigaLan; LPT=Printer; mPCIe=miniPCIe



# HMI-043T Series



Model Name	HMI-043T	HMI-043T-OP
Display Size	4.3" WQVGA	4.3" WQVGA
Max. Resolution	480 x 272	480 x 272
Luminance (cd/m <sup>2</sup> )	280	280
Touch Screen	Analog Resistive	Analog Resistive
CPU	Vortex86EXm-400MHz	Vortex86EX-400MHz
System Memory	128MB/256MB	128MB/256MB
I/O	1S/1U/CAN/LAN/Audio/8GPIO	3S/2U/LCD/LAN/CAN/Audio/8GPIO
Storage	SD Slot/512MB or 8GB eMMC	512MB/8GB eMMC
Expansion I/O	HF RFIC	3 Configurable I/O Ports
Power Requirement	+7VDC ~ 24VDC	+5VDC
Operating Temp.	0 ~ +50°C / -20 ~ +60°C	-20 ~ +60°C
Dimension (WxHxD mm)	116.4 x 94.4 x 34.36	105.5 x 67.2 x 13.6
Certificate	CE, FCC, VCCI, Shock, Vibration, IP65 (Front Panel)	N/A

■ S=RS232/422/485; U=USB; GLAN=GigaLan; LPT=Printer; mPCle=miniPCle

# Open Frame Series



Model Name	VOX-070-TS	VOX-065-TS	VOX-084-TS	VOX-090-TS	VOX-104-TS	VOX-150-TS
Display Size	7" WVGA / WSVGA	6.5" VGA	8.4" SVGA	9" WSVGA	10.4" SVGA	15" XGA
Max. Resolution	800 x 480 / 1024 x 600	640 x 480	800 x 600	1024 x 600	800 x 600	1024 x 768
Luminance (cd/m <sup>2</sup> )	400/500	800	250	300	300	350
Touch Screen	Analog Resistive					
CPU	Vortex86EX2 -600MHz / NXP i.MX8M Mini	Vortex86DX2-933MHz / Vortex86DX3-1GHz / Intel® Braswell x5-E8000 / N7310 / N3160 / 9" Support NXP i.MX8M Mini				
System Memory	1GB/2GB	1GB/2GB/4GB				
Storage	eMMC onboard / SD Slot	SATA / mSATA / eMMC onboard for NXP i.MX8M Mini only				
Expansion I/O	MiniPCle Slot					
Power Requirement	+12 ~ +36VDC	+5VDC & +12VDC / +12VDC / +12V~36VDC				
Operating Temp.	0 ~ +50°C / -20 ~ +60°C					

■ S=RS232/422/485; U=USB; GLAN=GigaLan; LPT=Printer; mPCle=miniPCle

## iBPC Series

- CPU : DMP Vortex86DX3
- Operating Temp. : -20 ~ +70°C
- Dimensions : 151.7 x 103 x 53.3mm
- Features : Panel mounting available  
Isolated GPIO  
LVDS support  
10 years life cycle



Part No.	CPU	RAM	Storage	I/O
iBPC-75GE	Vortex86DX3-1GHz	2GB Max.	SATA / Micro SD/	3S / 4U / 2GLAN / LAN / Audio / 8GPIO / 8GPIO (isolated) / VGA / LVDS
iBPC-75CE	Vortex86DX3-1GHz	2GB Max.	SATA / Micro SD	3S / 4U / 2GLAN / LAN / Audio / 8GPIO (isolated) / VGA / LVDS / CAN
iBPC-75FE	Vortex86DX3-1GHz	2GB Max.	SATA / Micro SD	3S / 4U / 2GLAN / LAN / Audio / 8GPIO / 8GPIO (isolated) / VGA / LVDS

■ S=RS232/422/485; U=USB; GLAN=GigaLan; LPT=Printer; mPCIe=miniPCIe

## EBOX-3362 Series

- CPU : DMP Vortex86DX3
- Operating Temp. : -20 ~ +70°C
- Dimensions : 115 x 115 x 35mm
- Features : 100 x 100mm VESA support  
Compact design  
Fanless design and DIN Rail rack  
10 years life cycle



■ VESA Mount

■ Din-Rail rack

Part No.	CPU	RAM	Storage	I/O
EB-3362-L2851C3P-I	Vortex86DX3-1GHz	2GB Max.	SATA / SD	4S / 3U / GLAN / LAN / Line-out / mPCIe / VGA
EB-3362-C2G2SIM-I	Vortex86DX3-1GHz	2GB Max.	SATA / SD	2S / 3U / LAN / Line-out / 16GPIO / mPCIe / VGA
EB-3362-L2C2851G1E-I	Vortex86DX3-1GHz	2GB Max.	SATA	3S / 3U / GLAN / LAN / Mic-in / Line-out / 8GPIO / VGA

■ S=RS232/422/485; U=USB; GLAN=GigaLan; LPT=Printer; mPCIe=miniPCIe

# D-3362 Series

- CPU : DMP Vortex86DX3
- Operating Temp. : -20 ~ +70°C
- Dimensions : 151.7 x 103 x 53.3mm
- Features : Fanless design  
DIN Rail rack  
10 years life cycle



▪ DIN-Rail rack

Part No.	CPU	RAM	Storage	I/O
D-3362-852C2-I	Vortex86DX3-1GHz	2GB Max.	SATA / SD (Internal)	4S / 2U / GLAN / LAN / mPCIe / VGA
D-3362-851C1G2-I	Vortex86DX3-1GHz	2GB Max.	SATA / SD (Internal)	2S / 2U / GLAN / LAN / mPCIe / 16GPIO / VGA

▪ S=RS232/422/485; U=USB; GLAN=GigaLan; LPT=Printer; mPCIe=miniPCIe

# ICE-104 Series

- CPU : DMP Vortex86DX3
- Operating Temp. : -100 ~ +80°C Max.
- Dimensions : 181.6 x 184.7 x 56.6mm
- Features : 100 x 100mm VESA support  
IP67 dust&water design enclosure  
Support PC/104 form factor  
Customizable I/O ports configuration services



Part No.	CPU	RAM	Storage	I/O
ICE-6754-DC	Vortex86DX3-1GHz	2GB Max.	SATA	3S / 2U / 16GPIO / VGA

▪ S=RS232/422/485; U=USB; GLAN=GigaLan; LPT=Printer; mPCIe=miniPCIe

### ICE-104 \_ Passive Cooling Design / Active Warming System Design

- Heat flows through enclosure
- Active warming design form factor
- Works below freezing



### ICE-104 \_ Customizable Service & Function

- Company Logo engraving services
- Customizable I/O panels services
- Stackable Chassis system form



# EBOX-335xDX3 Series

- **Operating Temp.** : 0 ~ +60°C / -20 ~ +70°C
- **Dimensions** : 95 x 95 x 20mm / 95 x 95 x 35mm
- **Features** : GLAN support  
Fanless design  
PXE Diskless Boot  
Auto Power On support  
75 x 75mm VESA support



Part No.	CPU	RAM	Storage	I/O
EBOX-335xDX3	Vortex86DX3-1GHz	1GB 2GB	SD	2S / 3U / LAN / Mic-in / Line-out / VGA
EBOX-335xDX3-GL	Vortex86DX3-1GHz	1GB 2GB	SD	2S / 3U / GLAN / Mic-in / Line-out / VGA
EBOX-335xDX3-W	Vortex86DX3-1GHz	1GB 2GB	SD	2S / 3U / LAN / Mic-in / Line-out / VGA
EBOX-335xDX3-GLW	Vortex86DX3-1GHz	1GB 2GB	SD	2S / 3U / GLAN / Mic-in / Line-out / VGA
EBOX-335xDX3-RCA	Vortex86DX3-1GHz	1GB 2GB	SATA / Micro SD	3U / LAN / Mic-in / Line-out / VGA / mPCIe / HDMI / RCA jack

■ S=RS232/422/485; U=USB; GLAN=GigaLan; LPT=Printer; mPCIe=miniPCIe

# EBOX-335xDX3-C2 Series

- **Operating Temp.** : 0 ~ +60°C / -20 ~ +70°C
- **Dimensions** : 95 x 95 x 35mm
- **Features** : GLAN support  
Dual RS-232 support  
Fanless design  
PXE Diskless Boot  
Auto Power On support  
75 x 75mm VESA support



Part No.	CPU	RAM	Storage	I/O
EBOX-335xDX3	Vortex86DX3-1GHz	1GB 2GB	SD	2S / 3U / LAN / Mic-in / Line-out / VGA
EBOX-335xDX3 1G LAN	Vortex86DX3-1GHz	1GB 2GB	SD	2S / 3U / GLAN / Mic-in / Line-out / VGA
EBOX-335xDX3 Wide Temp.	Vortex86DX3-1GHz	1GB 2GB	SD	2S / 3U / LAN / Mic-in / Line-out / VGA
EBOX-335xDX3 1G LAN Wide Temp.	Vortex86DX3-1GHz	1GB 2GB	SD	2S / 3U / GLAN / Mic-in / Line-out / VGA

■ S=RS232/422/485; U=USB; GLAN=GigaLan; LPT=Printer; mPCIe=miniPCIe



## EBOX-336x Standard Series

- **Operating Temp.** : 0 ~ +60°C / -20 ~ +70°C
- **Dimensions** : 115 x 115 x 35mm
- **Features** : Dual-core CPU All-in-One Module  
Multiple RS-232 / 485 / 422 / GPIO / CANbus  
100 x 100mm VESA support  
Fanless design and DIN Rail rack  
Auto Power On / PXE Diskless Boot



Part No.	CPU	RAM	Storage	I/O
EB-336x HDMI	Vortex86DX3-1GHz	1GB 2GB	SATA / SD	4S / 3U / GLAN / LAN / CAN / Mic-in / Line-out / mPCIe / HDMI
EB-336x RS-232	Vortex86DX3-1GHz	1GB 2GB	SATA / SD	4S / 3U / GLAN / LAN / CAN / Line-out / mPCIe / 16GPIO / VGA
EB-336x RS-485	Vortex86DX3-1GHz	1GB 2GB	SATA / SD	4S / 3U / GLAN / LAN / CAN / Mic-in / Line-out / mPCIe / 16GPIO / VGA
EB-336x RS-422	Vortex86DX3-1GHz	1GB 2GB	SATA / SD	4S / 3U / GLAN / LAN / CAN / Line-out / mPCIe / 16GPIO / VGA

■ S=RS232/422/485; U=USB; GLAN=GigaLan; LPT=Printer; mPCIe=miniPCIe

## EBOX-336x Special Series

- **Operating Temp.** : 0 ~ +60°C / -20 ~ +70°C
- **Dimensions** : 115 x 115 x 35mm
- **Features** : Dual-core CPU All-in-One Module  
Multiple LANs & COM ports  
SATA, CF, SD card, mPCIe, 4G LTE  
Auto Power On / PXE Diskless Boot  
100 x 100mm VESA support  
Fanless design and DIN Rail rack



Part No.	CPU	RAM	Storage	I/O
EBOX-336x 4G LTE	Vortex86DX3-1GHz	1GB 2GB	SATA / SD	4S / 3U / LAN / CAN / Line-out / mPCIe / 16GPIO / VGA
EBOX-336x GPIO	Vortex86DX3-1GHz	1GB 2GB	SATA / SD	4S / 3U / GLAN / LAN / CAN / Line-out / mPCIe / 16GPIO / VGA
EBOX-336x Multi LAN	Vortex86DX3-1GHz	1GB 2GB	SATA / SD	4S / 4U / 2GLAN / LAN / CAN / Mic-in / Line-out / mPCIe / 16GPIO / VGA
EBOX-336x Special IO	Vortex86DX3-1GHz	1GB 2GB	SATA / CF / SD	3S / 3U / GLAN / LAN / LPT / Line-out / VGA

■ S=RS232/422/485; U=USB; GLAN=GigaLan; LPT=Printer; mPCIe=miniPCIe

# EBOX-IMX8MM Series

- **Operating Temp.** : 0 ~ +60°C / -40 ~ +80°C
- **Dimensions** : 115 x 115 x 35mm
- **Features** : 2GB / 4GB LPDDR4, 16GB eMMC onboard  
Fanless design / DIN Rail rack  
100 x 100mm VESA support  
GLAN, RS-232 / 485  
Auto Power On support



Part No.	CPU	RAM	Storage	I/O
EBOX-IMX8MM w/RS-232	NXP i.MX8M Mini Quad-Core 1.6GHz	2GB 4GB	eMMC / Micro SD	2S / 3U / GLAN / Line-out / mPCIe / HDMI
EBOX-IMX8MM w/RS-485	NXP i.MX8M Mini Quad-Core 1.6GHz	2GB 4GB	eMMC / Micro SD	2S / 3U / GLAN / Line-out / mPCIe / HDMI
EBOX-IMX8MM w/WiFi & BT	NXP i.MX8M Mini Quad-Core 1.6GHz	2GB 4GB	eMMC / Micro SD	2S / 3U / GLAN / Line-out / mPCIe / HDMI
EBOX-IMX8MM w/RS-232, Dual LAN	NXP i.MX8M Mini Quad-Core 1.6GHz	2GB 4GB	eMMC / Micro SD	2S / 3U / 2GLAN / Line-out / mPCIe / HDMI
EBOX-IMX8MM w/RS-485, Dual LAN	NXP i.MX8M Mini Quad-Core 1.6GHz	2GB 4GB	eMMC / Micro SD	2S / 3U / 2GLAN / Line-out / mPCIe / HDMI
EBOX-IMX8MM w/WiFi & BT, Dual LAN	NXP i.MX8M Mini Quad-Core 1.6GHz	2GB 4GB	eMMC / Micro SD	2S / 3U / 2GLAN / Line-out / mPCIe / HDMI

■ S=RS232/422/485; U=USB; GLAN=GigaLan; LPT=Printer; mPCIe=miniPCIe

# DIN PC-336x Series

- **Operating Temp.** : 0 ~ +60°C / -20 ~ +70°C
- **Dimensions** : 151.7 x 103 x 53.3mm
- **Features** : Dual-core CPU All-in-One Module  
Fanless, DIN Rail support  
GLAN, RS-232 / 485 / 422 / GPIO  
PXE Diskless Boot  
Auto Power On support



Part No.	CPU	RAM	Storage	I/O
D-336x-C2	Vortex86DX3-1GHz	1GB 2GB	SATA / SD (Internal)	2S / 2U / GLAN / LAN / VGA
D-336x-C4	Vortex86DX3-1GHz	1GB 2GB	SATA / SD (Internal)	4S / 2U / GLAN / LAN / VGA
D-336x-852C2	Vortex86DX3-1GHz	1GB 2GB	SATA / SD (Internal)	4S / 2U / GLAN / LAN / VGA
D-336x-852G2	Vortex86DX3-1GHz	1GB 2GB	SATA / SD (Internal)	2S / 2U / GLAN / LAN / 16GPIO / VGA
D-336x-C2G2A	Vortex86DX3-1GHz	1GB 2GB	SATA / SD (Internal)	2S / 2U / GLAN / LAN / Mic-in / Line-out / 16GPIO / VGA

■ S=RS232/422/485; U=USB; GLAN=GigaLan; LPT=Printer; mPCIe=miniPCIe

# EBOX Apollo Lake Series

- **Operating Temp.** : 0 ~ +60°C / -20 ~ +60°C
- **Dimensions** : 115 x 115 x 48.5mm
- **Features** : Multi-Display outputs  
Multi-COM functions  
Dual GLAN, Fanless  
100 x 100mm VESA support  
Full size and Half size mPCIe



Part No.	CPU	RAM	Storage	I/O
EBOX-ALN3350 w/COM	Intel® Apollo Lake N3350 Dual-Core 1.1GHz	4GB 8GB	mSATA SATA	1S / 4U / 2GLAN / 2HDMI / VGA Audio / mPCIe
EBOX-ALN3350 w/8-bit GPIO	Intel® Apollo Lake N3350 Dual-Core 1.1GHz	4GB 8GB	mSATA SATA	4U / 2GLAN / 2HDMI / VGA Audio / mPCIe / 8GPIO
EBOX-ALN3350 w/COM & 8-bit GPIO	Intel® Apollo Lake N3350 Dual-Core 1.1GHz	4GB 8GB	mSATA SATA	1S / 4U / 2GLAN / 2HDMI Audio / mPCIe / 8GPIO
EBOX-ALN3455 w/COM	Intel® Apollo Lake N3455 Quad-Core 1.5GHz	4GB 8GB	mSATA SATA	1S / 4U / 2GLAN / 2HDMI / VGA Audio / mPCIe
EBOX-ALN3455 w/8-bit GPIO	Intel® Apollo Lake N3455 Quad-Core 1.5GHz	4GB 8GB	mSATA SATA	4U / 2GLAN / 2HDMI / VGA Audio / mPCIe / 8GPIO
EBOX-ALJ3455 w/COM & 8-bit GPIO	Intel® Apollo Lake N3455 Quad-Core 1.5GHz	4GB 8GB	mSATA SATA	1S / 4U / 2GLAN / 2HDMI Audio / mPCIe / 8GPIO

■ S=RS232/422/485; U=USB; GLAN=GigaLan; LPT=Printer; mPCIe=miniPCIe

# EBOX Braswell Series

- **Operating Temp.** : 0 ~ +60°C
- **Dimensions** : 115 x 115 x 35mm
- **Features** : AMI UEFI BIOS (Legacy mode switchable)  
M.2 2230 E Key support  
GLAN, RS-232 / 485  
100 x 100mm VESA support  
Auto Power On support



Part No.	CPU	RAM	Storage	I/O
EB-58E w/RS-232	Atom® x5-E8000 Quad-Core 1.04GHz	4GB 8GB	SATA / Micro SD	2S / 4U / GLAN / Mic-in / Line-out / M.2 / HDMI
EB-58E w/RS-485	Atom® x5-E8000 Quad-Core 1.04GHz	4GB 8GB	SATA / Micro SD	2S / 4U / GLAN / Mic-in / Line-out / M.2 / HDMI
EB-58E w/RS-232, Dual LAN	Atom® x5-E8000 Quad-Core 1.04GHz	4GB 8GB	SATA / Micro SD	2S / 4U / 2GLAN / Mic-in / Line-out / M.2 / HDMI
EB-58E w/RS-485, Dual LAN	Atom® x5-E8000 Quad-Core 1.04GHz	4GB 8GB	SATA / Micro SD	2S / 4U / 2GLAN / Mic-in / Line-out / M.2 / HDMI
EB-58N w/RS-232	Celeron® N3160 Quad-Core 1.6GHz	4GB 8GB	SATA / Micro SD	2S / 4U / GLAN / Mic-in / Line-out / M.2 / HDMI
EB-58N w/RS-485	Celeron® N3160 Quad-Core 1.6GHz	4GB 8GB	SATA / Micro SD	2S / 4U / GLAN / Mic-in / Line-out / M.2 / HDMI
EB-58N w/RS-232, Dual LAN	Celeron® N3160 Quad-Core 1.6GHz	4GB 8GB	SATA / Micro SD	2S / 4U / 2GLAN / Mic-in / Line-out / M.2 / HDMI
EB-58N w/RS-485, Dual LAN	Celeron® N3160 Quad-Core 1.6GHz	4GB 8GB	SATA / Micro SD	2S / 4U / 2GLAN / Mic-in / Line-out / M.2 / HDMI

■ S=RS232/422/485; U=USB; GLAN=GigaLan; LPT=Printer; mPCIe=miniPCIe

# QEC-EtherCAT Solutions

ICOP Technology provides a complete solution for EtherCAT – the QEC Series, which includes EtherCAT master motion controllers and EtherCAT slave modules (I/O, RS232/485, MPG, converters, motion control/drivers). With highly integrated hardware and software features, the QEC series supports a wide range of industrial automation applications and provides fast, simple, and often used/readily available functions while shortening development cycles. It can also build Database through MySQL library, which helps create smart IIoT technology.

## Easily Develop EtherCAT

QEC supports the Arduino development environment, allowing project development processes to be accelerated with rich built-in examples and libraries and making system configuration streamlined through virtual programming tools and database libraries. This results in an easy, accelerated EtherCAT solution.



EtherCAT I/O

EtherCAT

EtherCAT

Stepper Motor Controller



HMI Editor



86EVA EtherCAT Configurator

## Arduino Development Environment



ArduBlock Tools



SQL Database

### EtherCAT Slave Device



### EtherCAT Master Device

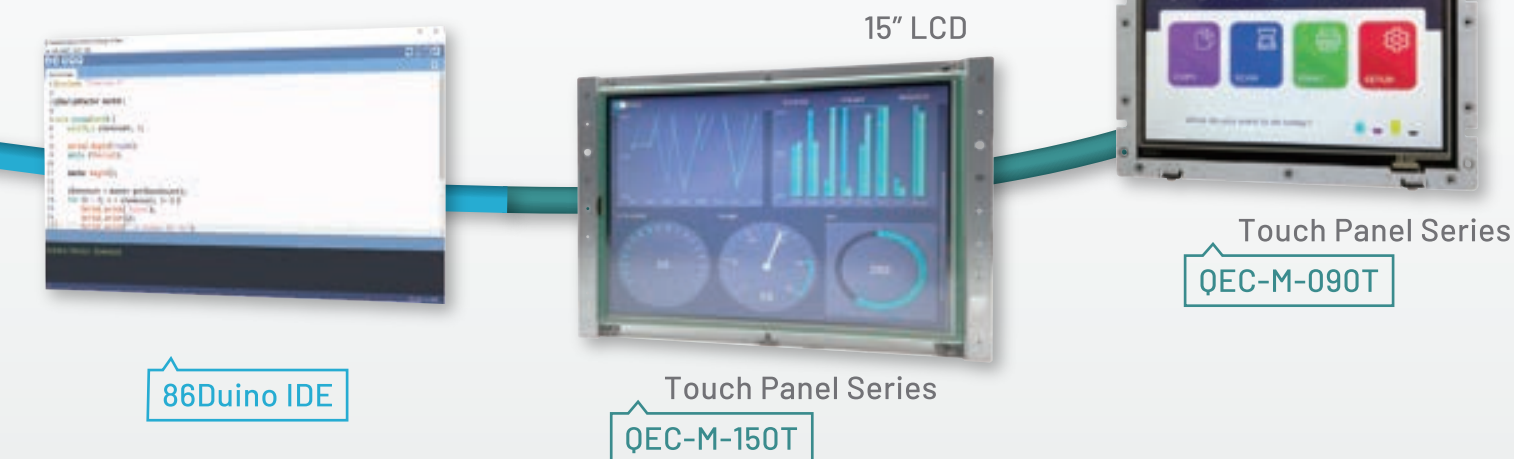

	<p><b>Real-time &amp; Reliability</b></p> <ul style="list-style-type: none"> <li>• Synchronous motion control of up to 32 axes</li> <li>• Minimum Communication Cycle 125us</li> <li>• Motion Control Environment</li> </ul>		<p><b>Compatibility</b></p> <ul style="list-style-type: none"> <li>• Support for Third-Party EtherCAT Slaves</li> <li>• Offer ESI file</li> </ul>
	<p><b>Easy Operation</b></p> <ul style="list-style-type: none"> <li>• Arduino Development Environment</li> <li>• HMI Resources &amp; Tools</li> <li>• Various Libraries &amp; Examples</li> </ul>		<p><b>Service</b></p> <ul style="list-style-type: none"> <li>• Professional Support Team</li> <li>• HMI Customization Service</li> <li>• ArduBlock Tool Collaboration Service</li> </ul>

# QEC-M, EtherCAT Master

The QEC-M series is an EtherCAT master control system based on the Vortex86EX2 processor, that provides two independent cores to meet the requirement of hardware and software real-time and reliable synchronous control.

The development environment uses industrial-Arduino software, 86Duino IDE, supporting a dedicated EtherCAT library and 3 graphical tools, which allows users to reduce development time and engineer threshold by using 86Duino IDE's rich built-in functions, examples, and libraries.

## QEC-M-01

EtherCAT Master

### Features

- Built-in Integrated API dev
- Small-size, DIN-Rail, Simple Wiring
- User-friendly, Easy Install, Time Saving



## QEC-M-043T

4.3-inch LCD  
EtherCAT Master

### Features

- Support LVGL GUI Graphics Library
- HMI EtherCAT Master Solution
- Interactive User Interface



## QEC-M-070T/090T

7-inch / 9-inch LCD  
Open Frame  
EtherCAT Master

### Features

- Full Arduino Pinout and Library
- Open Frame, Easy to Embedded
- Powerful & Versatile EtherCAT Master



## QEC-M-150T

15-inch LCD  
Open Frame  
EtherCAT Master

### Features

- 15" TFT 1024x768 Resistive Touch LCD
- Larger Screen with Higher Resolution
- Can Adopt UI Design from Other QEC-M



# QEC-R, EtherCAT Slave Modules

## QEC-R00D0FD

16-ch Digital Output



### Features

- Load Voltage Range: +24 ~ +56V DC
- Load Current: 1A
- Min. 1500 Vrms Optical Isolation
- Frequency Range up to 8KHz
- MOS-FET Relay

## QEC-R00DF0S

16-ch Digital Input



### Features

- Input Voltage Range: +24 ~ +56V DC
- Reverse Polarity Protection
- Min. 2000 Vrms Optical Isolation
- Frequency Range up to 8KHz
- Wire-break Detection

## QEC-R00HUAS

Human Interface Device



### Features

- Support Two Standard RS232/485 (Easy Change by Switch)
- Support MPG Hand-wheel
- Support Keypad + LCM
- LED Indicators for Status

## QS00-RKI0GEDB

I2C/SPI Analog Input



### Features

- Support SPI/I2C Interface
- 8-slot Customization Analog Input
- Vp/Vs Dual Isolated Power Input
- Multi-Color Terminal Blocks
- LED Indicators for Analog Status

## QEC-R00MP3S

Stepper Motor Controller



### Features

- 3 Stepper Motors, 2-phase Bipolar
- Drive Current up to 4.5A
- Encoder Interfaces, Differential
- 16 micro-steps per Full Step
- Automatic Current Reduction

## QEC-R00UN01

LCD Touch Screen



### Features

- Suitable Arduino Pin Assignment
- Support 2.5" and 3.5" TFT LCD
- Support Full Software API library
- Vp/Vs Dual Isolated Power Input
- LED Indicators for I/O Status

## QEC-R00JT1S

Extender Junction



### Features

- Handles Efficient Network Traffic
- Distance up to 100 m
- Support Daisy Chain and Star Connection
- Vp/Vs Dual Isolated Power Input

## QEC-R00JT3S

Fiber Optics Junction



### Features

- Support Fiber Optic Connector
- Handles Efficient Network Traffic
- Distance up to 20km
- Support Daisy Chain and Star Connection

# Flash Disk

## IDE DOM Series

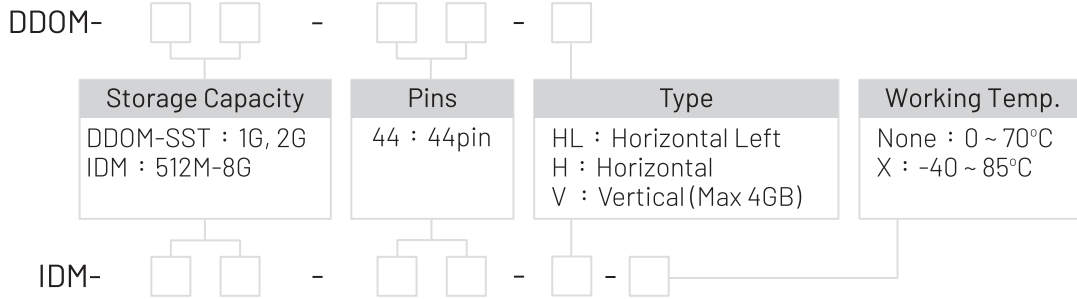

## SATA DOM Series

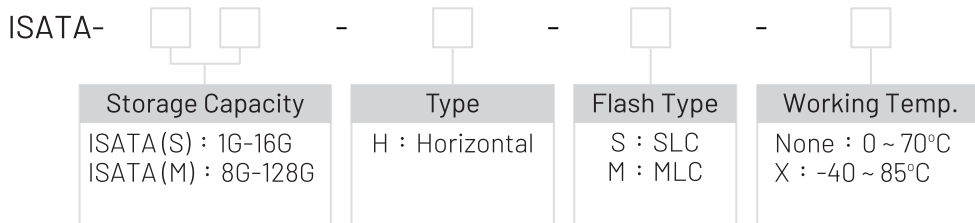

## SATA SLIM Series

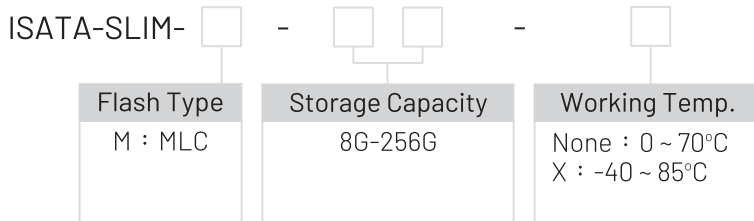

## M.2 Series (SATA 2242 M key)

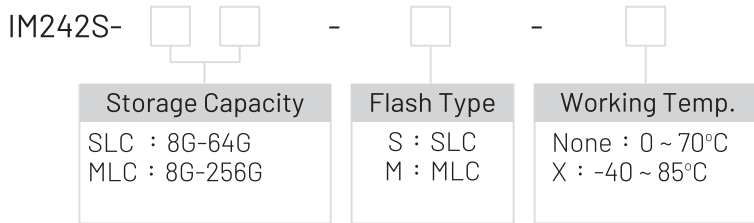

## mSATA Series

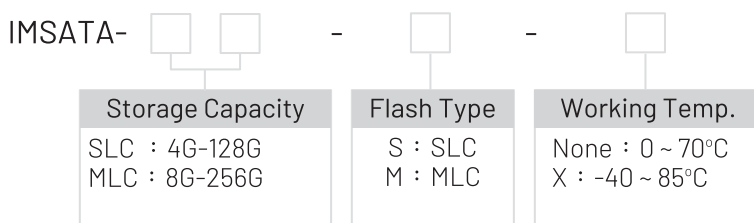

## Mini PCIe DOM

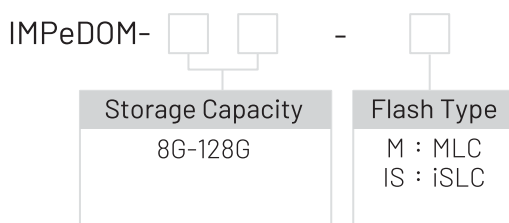



# Peripheral



## DCM

DC to DC power module



## SERIALCAN

UART to CAN module



## ICOP-0072

PC/104 DC to DC + 24-bit digital I/O card



## ICOP-1800

PC/104 RS232 x 4 port card



## ICOP-0101

PC/104 48-bit digital I/O card



## ICOP-0102

PC/104 24-bit digital I/O card



## MINIPCI-E-9160

Mini-PCIe VGA card



## MINIPCI-E-4S

Mini-PCIe to four RS232 card



## SD-1917

IDE (44pin) to Micro SD Controller



## CF-1916

IDE (44pin) to Compact Flash Type I/II



## CF-1915

IDE (44pin) to Compact Flash Type I/II



## ICOP-0076

LAN Adapter Kit

# Memo

---

# Memo

---

### ICOP Technology Inc.

No.15, Wugong 5th Rd, Xinzhuang Dist.,  
New Taipei City 248020, Taiwan  
新北市新莊區五工五路15號  
URL : [www.icop.com.tw](http://www.icop.com.tw)  
Email : [info@icop.com.tw](mailto:info@icop.com.tw)  
Tel : +886-2-8990-1933  
Fax : +886-2-8990-2045

### ICOP Technology Inc. (USA)

177 South Brent Circle, City of Industry, CA 91789, U.S.A  
URL : [www.icoptech.com](http://www.icoptech.com)  
Email : [info@icoptech.com](mailto:info@icoptech.com)  
Tel : +1-909-595-2333  
Fax : +1-909-595-2331

### ICOP Technology S. de R.L. de C.V. (Mexico)

Rio Lerma No.196 Int.301 Cuauhtémoc, C.P. 06500 CDMX  
URL : [www.icoptech.com](http://www.icoptech.com)  
Email : [info@icoptech.com](mailto:info@icoptech.com)  
Teléfono: (55) 5207-2660  
Móvil: 556818-1999  
Ventas y Soporte Técnico:556319-7787

### ICOP I.T.G. (Japan)

〒101-0021東京都千代田区外神田 6-16-9-8F  
URL : [www.icop.co.jp](http://www.icop.co.jp)  
Email : [info@icop.co.jp](mailto:info@icop.co.jp)  
Tel : (03) 3831-6666  
Fax : (03) 5846-6600

### ICOP Technology GmbH (Germany)

Beethovenplatz 1-3, 60325 Frankfurt am Main, Germany  
URL : [www.icoptech.eu](http://www.icoptech.eu)  
Email : [info@icoptech.eu](mailto:info@icoptech.eu)  
Tel : +49 (0) 69-2475-687-0  
Fax : +49 (0) 69-2475-687-77

### ICOP Technology Inc. (BeiJing)

北京市丰台区科技园区海鹰路6号院23号楼  
URL : [www.icop.com.cn](http://www.icop.com.cn)  
Email : [sales@icop.com.cn](mailto:sales@icop.com.cn)  
Tel : +86-10-6389-8777  
Fax : +86-10-6526-8777

### ICOP Technology Inc. (ShangHai)

上海市漕河泾高科技园区古美路1515号19栋902室  
URL : [www.icop.com.cn](http://www.icop.com.cn)  
Email : [sales@icop.com.cn](mailto:sales@icop.com.cn)  
Tel : +86-21-5445-1777  
Fax : +86-21-5445-1767

### ICOP Technology Inc. (ShenZhen)

深圳市龙华新区龙华街道和平路46号  
金凤凰豪苑C栋303-306  
URL : [www.icop.com.cn](http://www.icop.com.cn)  
Email : [sales@icop.com.cn](mailto:sales@icop.com.cn)  
Tel : +86-755-2650-0777  
Fax : +86-755-2650-5111

### ICOP Technology Inc. (Xi'An)

西安市高新区(雁塔区)科技路48号创业广场A0502  
URL : [www.icop.com.cn](http://www.icop.com.cn)  
Email : [sales@icop.com.cn](mailto:sales@icop.com.cn)  
Tel : +86-29-8799-7777  
Fax : +86-29-8799-7666



## ICOP Technology Inc.

All trademarks appearing in this manuscript are registered trademark of their respective owners.

All specifications are subject to change without notice.

Copyright 2023 ICOP Technology Inc. All Right Reserved.

230814v2



ICOP Online Shop