



鎢鋼鑽頭系列

Carbide  
Drill Bit Series

# 鎢鋼高速鑽頭×3D

## Carbide High Speed Drill x3D

低碳素鋼 Low Carbon Steels	中碳素鋼 Medium Carbon Steels	高碳素鋼 High Carbon Steels	合金鋼 Alloy Steels	工具鋼 Tool Steels	調質鋼 Hardened Steels	淬火鋼 Quenched and Tempered Steels			鑄鋼 Cast Steels	鑄鐵 Cast Iron	黃銅 Brass	青銅 Bronze	紅銅 Copper	鋁合金 Aluminum Rolled	不銹鋼 Stainless Steels			鈦合金 Titanium Alloys	鎳基合金 Nickel Alloys	碳纖維 Carbon Fiber	玻璃纖維 Glass Fiber	
C0.25%以下	C0.25%~0.45%	C0.45%以上	SCM	SKD	HRC 20~30	HRC 30~40	HRC 40~50	HRC 50~60	SC	FC	FCD	BS	PB	CU	AL	300	400	600	TI			
◎	◎	◎	○	○	○	○	○		○	◎	○						○	○				

○適用 ◎專用

◆特性：使用了優異耐削性和耐磨性的特殊刀刃形狀，不僅提升了刀具的穩定性，其鑽頭的中心定位也更加準確。

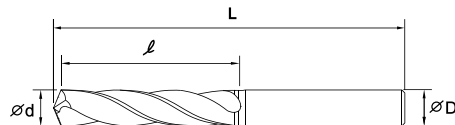

### DAS3D2A

單位:mm(Unit:mm)

刀具料號 Model No.	刃徑 d Diameter	溝長 l Grooving Length	全長 L Overall Length	柄徑 D Shank Diameter	在庫
DAS3D2A0250A	2.5	16	50	4	●
DAS3D2A0255A	2.55			4	●
DAS3D2A0260A	2.6			4	●
DAS3D2A0265A	2.65			4	●
DAS3D2A0270A	2.7			4	●
DAS3D2A0275A	2.75			4	●
DAS3D2A0280A	2.8			4	●
DAS3D2A0285A	2.85			4	●
DAS3D2A0290A	2.9			4	●
DAS3D2A0295A	2.95			4	●
DAS3D2A0030A	3.0	18	55	4	●
DAS3D2A3054A	3.05			4	●
DAS3D2A3104A	3.1			4	●
DAS3D2A3154A	3.15			4	●
DAS3D2A3204A	3.2			4	●
DAS3D2A3254A	3.25			4	●
DAS3D2A3304A	3.3			4	●
DAS3D2A3354A	3.35			4	●
DAS3D2A3404A	3.4			4	●
DAS3D2A3454A	3.45			4	●
DAS3D2A3504A	3.5	21	60	4	●
DAS3D2A3554A	3.55			4	●
DAS3D2A3604A	3.6			4	●
DAS3D2A3654A	3.65			4	●
DAS3D2A3704A	3.7			4	●
DAS3D2A3754A	3.75			4	●
DAS3D2A3804A	3.8			4	●
DAS3D2A3854A	3.85			4	●
DAS3D2A3904A	3.9			4	●
DAS3D2A3954A	3.95			4	●
DAS3D2A4004A	4.0	16	50	4	●
DAS3D2A3006A	3.0			6	●

○: 接單生產品 ●: 在庫品 ▲: 訂製品

# 鎢鋼高速鑽頭×3D

## Carbide High Speed Drill x3D

### DAS3D2A

單位:mm(Unit:mm)

刀具料號 Model No.	刃徑 d Diameter	溝長 L Grooving Length	全長 L Overall Length	柄徑 D Shank Diameter	在庫
DAS3D2A0305A	3.05	18	55	6	●
DAS3D2A0310A	3.1			6	●
DAS3D2A0315A	3.15			6	●
DAS3D2A0320A	3.2			6	●
DAS3D2A0325A	3.25			6	●
DAS3D2A0330A	3.3			6	●
DAS3D2A0335A	3.35			6	●
DAS3D2A0340A	3.4			6	●
DAS3D2A0345A	3.45			6	●
DAS3D2A0350A	3.5			6	●
DAS3D2A0355A	3.55	21	60	6	●
DAS3D2A0360A	3.6			6	●
DAS3D2A0365A	3.65			6	●
DAS3D2A0370A	3.7			6	●
DAS3D2A0375A	3.75			6	●
DAS3D2A0380A	3.8			6	●
DAS3D2A0385A	3.85			6	●
DAS3D2A0390A	3.9			6	●
DAS3D2A0395A	3.95			6	●
DAS3D2A0400A	4.0			6	●
DAS3D2A0405A	4.05	23	65	6	●
DAS3D2A0410A	4.1			6	●
DAS3D2A0415A	4.15			6	●
DAS3D2A0420A	4.2			6	●
DAS3D2A0425A	4.25			6	●
DAS3D2A0430A	4.3			6	●
DAS3D2A0435A	4.35			6	●
DAS3D2A0440A	4.4			6	●
DAS3D2A0445A	4.45			6	●
DAS3D2A0450A	4.5			6	●
DAS3D2A0455A	4.55	26	65	6	●
DAS3D2A0460A	4.6			6	●
DAS3D2A0465A	4.65			6	●
DAS3D2A0470A	4.7			6	●
DAS3D2A0475A	4.75			6	●
DAS3D2A0480A	4.8			6	●
DAS3D2A0485A	4.85			6	●
DAS3D2A0490A	4.9			6	●
DAS3D2A0495A	4.95			6	●
DAS3D2A0500A	5.0			6	●
DAS3D2A0505A	5.05	29	70	6	●
DAS3D2A0510A	5.1			6	●
DAS3D2A0515A	5.15			6	●
DAS3D2A0520A	5.2			6	●
DAS3D2A0525A	5.25			6	●
DAS3D2A0530A	5.3			6	●
DAS3D2A0535A	5.35			6	●
DAS3D2A0540A	5.4			6	●
DAS3D2A0545A	5.45			6	●
DAS3D2A0550A	5.5			6	●
DAS3D2A0555A	5.55	30	70	6	●
DAS3D2A0560A	5.6			6	●

○: 接單生產品    ●: 在庫品    ▲: 訂製品

# 鎢鋼高速鑽頭×3D

## Carbide High Speed Drill x3D

### DAS3D2A

單位:mm(Unit:mm)

刀具料號 Model No.	刃徑 d Diameter	溝長 L Grooving Length	全長 L Overall Length	柄徑 D Shank Diameter	在庫		
DAS3D2A0565A	5.65	30	70	6	●		
DAS3D2A0570A	5.7			6	●		
DAS3D2A0575A	5.75			6	●		
DAS3D2A0580A	5.8			6	●		
DAS3D2A0585A	5.85			6	●		
DAS3D2A0590A	5.9			6	●		
DAS3D2A0595A	5.95			6	●		
DAS3D2A0060A	6.0			6	●		
DAS3D2A0605A	6.05	33	75	8	●		
DAS3D2A0610A	6.1			8	●		
DAS3D2A0615A	6.15			8	●		
DAS3D2A0620A	6.2			8	●		
DAS3D2A0625A	6.25			8	●		
DAS3D2A0630A	6.3			8	●		
DAS3D2A0635A	6.35			8	●		
DAS3D2A0640A	6.4			8	●		
DAS3D2A0645A	6.45			8	●		
DAS3D2A0650A	6.5			8	●		
DAS3D2A0655A	6.55			35	80	8	●
DAS3D2A0660A	6.6					8	●
DAS3D2A0665A	6.65	8	●				
DAS3D2A0670A	6.7	8	●				
DAS3D2A0675A	6.75	8	●				
DAS3D2A0680A	6.8	8	●				
DAS3D2A0685A	6.85	8	●				
DAS3D2A0690A	6.9	8	●				
DAS3D2A0695A	6.95	8	●				
DAS3D2A0070A	7.0	8	●				
DAS3D2A0705A	7.05	36	80			8	●
DAS3D2A0710A	7.1					8	●
DAS3D2A0715A	7.15			8	●		
DAS3D2A0720A	7.2			8	●		
DAS3D2A0725A	7.25			8	●		
DAS3D2A0730A	7.3			8	●		
DAS3D2A0735A	7.35			8	●		
DAS3D2A0740A	7.4			8	●		
DAS3D2A0745A	7.45			8	●		
DAS3D2A0750A	7.5			8	●		
DAS3D2A0755A	7.55			38	85	8	●
DAS3D2A0760A	7.6					8	●
DAS3D2A0765A	7.65	8	●				
DAS3D2A0770A	7.7	8	●				
DAS3D2A0775A	7.75	8	●				
DAS3D2A0780A	7.8	8	●				
DAS3D2A0785A	7.85	8	●				
DAS3D2A0790A	7.9	8	●				
DAS3D2A0795A	7.95	8	●				
DAS3D2A0080A	8.0	8	●				
DAS3D2A0805A	8.05	41	85			10	●
DAS3D2A0810A	8.1					10	●
DAS3D2A0815A	8.15			10	●		
DAS3D2A0820A	8.2			10	●		

○: 接單生產品 ●: 在庫品 ▲: 訂製品

鎢鋼鑽頭系列

# 鎢鋼高速鑽頭×3D

## Carbide High Speed Drill x3D

### DAS3D2A

單位:mm(Unit:mm)

刀具料號 Model No.	刃徑 d Diameter	溝長 ℓ Grooving Length	全長 L Overall Length	柄徑 D Shank Diameter	在庫		
DAS3D2A0825A	8.25	41	85	10	●		
DAS3D2A0830A	8.3			10	●		
DAS3D2A0835A	8.35			10	●		
DAS3D2A0840A	8.4			10	●		
DAS3D2A0845A	8.45			10	●		
DAS3D2A0850A	8.5			10	●		
DAS3D2A0855A	8.55			10	●		
DAS3D2A0860A	8.6	43	90	10	●		
DAS3D2A0865A	8.65			10	●		
DAS3D2A0870A	8.7			10	●		
DAS3D2A0875A	8.75			10	●		
DAS3D2A0880A	8.8			10	●		
DAS3D2A0885A	8.85			10	●		
DAS3D2A0890A	8.9			10	●		
DAS3D2A0895A	8.95			10	●		
DAS3D2A0900A	9.0			10	●		
DAS3D2A0905A	9.05			46	90	10	●
DAS3D2A0910A	9.1					10	●
DAS3D2A0915A	9.15					10	●
DAS3D2A0920A	9.2					10	●
DAS3D2A0925A	9.25	10	●				
DAS3D2A0930A	9.3	10	●				
DAS3D2A0935A	9.35	10	●				
DAS3D2A0940A	9.4	10	●				
DAS3D2A0945A	9.45	10	●				
DAS3D2A0950A	9.5	10	●				
DAS3D2A0955A	9.55	47	95			10	●
DAS3D2A0960A	9.6					10	●
DAS3D2A0965A	9.65					10	●
DAS3D2A0970A	9.7			10	●		
DAS3D2A0975A	9.75			10	●		
DAS3D2A0980A	9.8			10	●		
DAS3D2A0985A	9.85			10	●		
DAS3D2A0990A	9.9			10	●		
DAS3D2A0995A	9.95			10	●		
DAS3D2A0100A	10.0			10	●		
DAS3D2A1005A	10.05			49	95	12	●
DAS3D2A1010A	10.1					12	●
DAS3D2A1015A	10.15					12	●
DAS3D2A1020A	10.2	12	●				
DAS3D2A1025A	10.25	12	●				
DAS3D2A1030A	10.3	12	●				
DAS3D2A1035A	10.35	12	●				
DAS3D2A1040A	10.4	12	●				
DAS3D2A1045A	10.45	12	●				
DAS3D2A1050A	10.5	12	●				
DAS3D2A1055A	10.55	51	105			12	●
DAS3D2A1060A	10.6					12	●
DAS3D2A1065A	10.65					12	●
DAS3D2A1070A	10.7			12	●		
DAS3D2A1075A	10.75			12	●		
DAS3D2A1080A	10.8			12	●		

○: 接單生產品    ●: 在庫品    ▲: 訂製品

鎢鋼鑽頭系列

# 鎢鋼高速鑽頭×3D

## Carbide High Speed Drill x3D

### DAS3D2A

單位:mm(Unit:mm)

刀具料號 Model No.	刃徑 d Diameter	溝長 ℓ Grooving Length	全長 L Overall Length	柄徑 D Shank Diameter	在庫
DAS3D2A1085A	10.85	51	105	12	●
DAS3D2A1090A	10.9			12	●
DAS3D2A1095A	10.95			12	●
DAS3D2A1100A	11.0			12	●
DAS3D2A1105A	11.05			12	●
DAS3D2A1110A	11.1	54		12	●
DAS3D2A1115A	11.15			12	●
DAS3D2A1120A	11.2			12	●
DAS3D2A1125A	11.25			12	●
DAS3D2A1130A	11.3			12	●
DAS3D2A1135A	11.35	55		12	●
DAS3D2A1140A	11.4			12	●
DAS3D2A1145A	11.45			12	●
DAS3D2A1150A	11.5			12	●
DAS3D2A1155A	11.55			12	●
DAS3D2A1160A	11.6	58	12	●	
DAS3D2A1165A	11.65		12	●	
DAS3D2A1170A	11.7		12	●	
DAS3D2A1175A	11.75		12	●	
DAS3D2A1180A	11.8		12	●	
DAS3D2A1185A	11.85		12	●	
DAS3D2A1190A	11.9		12	●	
DAS3D2A1195A	11.95		12	●	
DAS3D2A1200A	12.0		12	●	
DAS3D2A1205A	12.05		60	13	●
DAS3D2A1210A	12.1			13	●
DAS3D2A1215A	12.15			13	●
DAS3D2A1220A	12.2			13	●
DAS3D2A1225A	12.25			13	●
DAS3D2A1230A	12.3			13	●
DAS3D2A1235A	12.35	13		●	
DAS3D2A1240A	12.4	13		●	
DAS3D2A1245A	12.45	13		●	
DAS3D2A1250A	12.5	13		●	
DAS3D2A1255A	12.55	13		●	
DAS3D2A1260A	12.6	13		●	
DAS3D2A1265A	12.65	13		●	
DAS3D2A1270A	12.7	13		●	
DAS3D2A1275A	12.75	13		●	
DAS3D2A1280A	12.8	13	●		
DAS3D2A1285A	12.85	13	●		
DAS3D2A1290A	12.9	13	●		
DAS3D2A1295A	12.95	13	●		
DAS3D2A1300A	13.0	60	13	●	
DAS3D2A1305A	13.05		14	▲	
DAS3D2A1310A	13.1		14	▲	
DAS3D2A1315A	13.15		14	▲	
DAS3D2A1320A	13.2		14	▲	
DAS3D2A1325A	13.25	60	14	▲	
DAS3D2A1330A	13.3		14	▲	
DAS3D2A1335A	13.35		14	▲	
DAS3D2A1340A	13.4		14	▲	

○: 接單生產品 ●: 在庫品 ▲: 訂製品

鎢鋼鑽頭系列

# 鎢鋼高速鑽頭×3D

## Carbide High Speed Drill x3D

### DAS3D2A

單位:mm(Unit:mm)

刀具料號 Model No.	刃徑 d Diameter	溝長 ℓ Grooving Length	全長 L Overall Length	柄徑 D Shank Diameter	在庫	
DAS3D2A1345A	13.45	60	115	14	▲	
DAS3D2A1350A	13.5			●		
DAS3D2A1355A	13.55	62		14	▲	
DAS3D2A1360A	13.6			14	▲	
DAS3D2A1365A	13.65			14	▲	
DAS3D2A1370A	13.7			14	▲	
DAS3D2A1375A	13.75			14	▲	
DAS3D2A1380A	13.8			14	▲	
DAS3D2A1385A	13.85			14	▲	
DAS3D2A1390A	13.9			14	▲	
DAS3D2A1395A	13.95			14	▲	
DAS3D2A1400A	14.0			14	●	
DAS3D2A1405A	14.05	64	120	16	▲	
DAS3D2A1410A	14.1			16	▲	
DAS3D2A1415A	14.15			16	▲	
DAS3D2A1420A	14.2			16	▲	
DAS3D2A1425A	14.25			16	▲	
DAS3D2A1430A	14.3			16	▲	
DAS3D2A1435A	14.35			16	▲	
DAS3D2A1440A	14.4			16	▲	
DAS3D2A1445A	14.45			16	▲	
DAS3D2A1450A	14.5			16	●	
DAS3D2A1455A	14.55			66	16	▲
DAS3D2A1460A	14.6				16	▲
DAS3D2A1465A	14.65				16	▲
DAS3D2A1470A	14.7				16	▲
DAS3D2A1475A	14.75				16	▲
DAS3D2A1480A	14.8				16	▲
DAS3D2A1485A	14.85				16	▲
DAS3D2A1490A	14.9				16	▲
DAS3D2A1495A	14.95	16	▲			
DAS3D2A1500A	15.0	16	●			
DAS3D2A1505A	15.05	67	125		16	▲
DAS3D2A1510A	15.1				16	▲
DAS3D2A1515A	15.15			16	▲	
DAS3D2A1520A	15.2			16	▲	
DAS3D2A1525A	15.25			16	▲	
DAS3D2A1530A	15.3			16	▲	
DAS3D2A1535A	15.35			16	▲	
DAS3D2A1540A	15.4			16	▲	
DAS3D2A1545A	15.45			16	▲	
DAS3D2A1550A	15.5			16	●	
DAS3D2A1555A	15.55			70	16	▲
DAS3D2A1560A	15.6				16	▲
DAS3D2A1565A	15.65				16	▲
DAS3D2A1570A	15.7				16	▲
DAS3D2A1575A	15.75				16	▲
DAS3D2A1580A	15.8				16	▲
DAS3D2A1585A	15.85				16	▲
DAS3D2A1590A	15.9				16	▲
DAS3D2A1595A	15.95	16	▲			
DAS3D2A1600A	16.0	16	●			

○: 接單生產品    ●: 在庫品    ▲: 訂製品

# 鎢鋼高速鑽頭×5D

## Carbide High Speed Drill x5D

低碳素鋼 Low Carbon Steels	中碳素鋼 Medium Carbon Steels	高碳素鋼 High Carbon Steels	合金鋼 Alloy Steels	工具鋼 Tool Steels	調質鋼 Hardened Steels	淬火鋼 Quenched and Tempered Steels			鑄鋼 Cast Steels	鑄鐵 Cast Iron	黃銅 Brass	青銅 Bronze	紅銅 Copper	鋁合金 Aluminum Rolled	不銹鋼 Stainless Steels			鈦合金 Titanium Alloys	鎳基合金 Nickel Alloys	碳纖維 Carbon Fiber	玻璃纖維 Glass Fiber	
C0.25%以下	C0.25%~0.45%	C0.45%以上	SCM	SKD	HRC 20~30	HRC 30~40	HRC 40~50	HRC 50~60	SC	FC	FCD	BS	PB	CU	AL	300	400	600	TI			
◎	◎	◎	○	○	○	○	○		○	◎	○						○	○				

○適用 ◎專用

◆特性：使用了優異耐削性和耐磨性的特殊刀刃形狀，不僅提升了刀具的穩定性，其鑽頭的中心定位也更加準確。

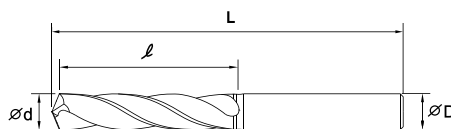

### DAS5D2B

單位:mm(Unit:mm)

刀具料號 Model No.	刃徑 d Diameter	溝長 l Grooving Length	全長 L Overall Length	柄徑 D Shank Diameter	在庫
DAS5D2B0250A	2.5	22	60	4	●
DAS5D2B0255A	2.55			●	
DAS5D2B0260A	2.6			●	
DAS5D2B0265A	2.65			●	
DAS5D2B0270A	2.7			●	
DAS5D2B0275A	2.75			●	
DAS5D2B0280A	2.8			●	
DAS5D2B0285A	2.85			●	
DAS5D2B0290A	2.9			●	
DAS5D2B0295A	2.95			●	
DAS5D2B0030A	3.0	25	65	4	●
DAS5D2B3054A	3.05			●	
DAS5D2B3104A	3.1			●	
DAS5D2B3154A	3.15			●	
DAS5D2B3204A	3.2			●	
DAS5D2B3254A	3.25			●	
DAS5D2B3304A	3.3			●	
DAS5D2B3354A	3.35			●	
DAS5D2B3404A	3.4			●	
DAS5D2B3454A	3.45			●	
DAS5D2B3504A	3.5	29	70	4	●
DAS5D2B3554A	3.55			●	
DAS5D2B3604A	3.6			●	
DAS5D2B3654A	3.65			●	
DAS5D2B3704A	3.7			●	
DAS5D2B3754A	3.75			●	
DAS5D2B3804A	3.8			●	
DAS5D2B3854A	3.85			●	
DAS5D2B3904A	3.9			●	
DAS5D2B3954A	3.95			●	
DAS5D2B4004A	4.0	22	60	4	●
DAS5D2B3006A	3.0			6	●

○: 接單生產品 ●: 在庫品 ▲: 訂製品



# 鎢鋼高速鑽頭×5D

## Carbide High Speed Drill x5D

### DAS5D2B

單位:mm(Unit:mm)

刀具料號 Model No.	刃徑 d Diameter	溝長 L Grooving Length	全長 L Overall Length	柄徑 D Shank Diameter	在庫
DAS5D2B0305A	3.05	25	65	6	●
DAS5D2B0310A	3.1			6	●
DAS5D2B0315A	3.15			6	●
DAS5D2B0320A	3.2			6	●
DAS5D2B0325A	3.25			6	●
DAS5D2B0330A	3.3			6	●
DAS5D2B0335A	3.35			6	●
DAS5D2B0340A	3.4			6	●
DAS5D2B0345A	3.45			6	●
DAS5D2B0350A	3.5			6	●
DAS5D2B0355A	3.55	29	70	6	●
DAS5D2B0360A	3.6			6	●
DAS5D2B0365A	3.65			6	●
DAS5D2B0370A	3.7			6	●
DAS5D2B0375A	3.75			6	●
DAS5D2B0380A	3.8			6	●
DAS5D2B0385A	3.85			6	●
DAS5D2B0390A	3.9			6	●
DAS5D2B0395A	3.95			6	●
DAS5D2B0400A	4.0			6	●
DAS5D2B0405A	4.05	32	75	6	●
DAS5D2B0410A	4.1			6	●
DAS5D2B0415A	4.15			6	●
DAS5D2B0420A	4.2			6	●
DAS5D2B0425A	4.25			6	●
DAS5D2B0430A	4.3			6	●
DAS5D2B0435A	4.35			6	●
DAS5D2B0440A	4.4			6	●
DAS5D2B0445A	4.45			6	●
DAS5D2B0450A	4.5			6	●
DAS5D2B0455A	4.55	36	80	6	●
DAS5D2B0460A	4.6			6	●
DAS5D2B0465A	4.65			6	●
DAS5D2B0470A	4.7			6	●
DAS5D2B0475A	4.75			6	●
DAS5D2B0480A	4.8			6	●
DAS5D2B0485A	4.85			6	●
DAS5D2B0490A	4.9			6	●
DAS5D2B0495A	4.95			6	●
DAS5D2B0500A	5.0			6	●
DAS5D2B0505A	5.05	40	85	6	●
DAS5D2B0510A	5.1			6	●
DAS5D2B0515A	5.15			6	●
DAS5D2B0520A	5.2			6	●
DAS5D2B0525A	5.25			6	●
DAS5D2B0530A	5.3			6	●
DAS5D2B0535A	5.35			6	●
DAS5D2B0540A	5.4			6	●
DAS5D2B0545A	5.45			6	●
DAS5D2B0550A	5.5			6	●
DAS5D2B0555A	5.55	42	90	6	●
DAS5D2B0560A	5.6			6	●

○: 接單生產品    ●: 在庫品    ▲: 訂製品

鎢鋼鑽頭系列

# 鎢鋼高速鑽頭×5D

## Carbide High Speed Drill x5D

### DAS5D2B

單位:mm(Unit:mm)

刀具料號 Model No.	刃徑 d Diameter	溝長 L Grooving Length	全長 L Overall Length	柄徑 D Shank Diameter	在庫
DAS5D2B0565A	5.65	42	90	6	●
DAS5D2B0570A	5.7			6	●
DAS5D2B0575A	5.75			6	●
DAS5D2B0580A	5.8			6	●
DAS5D2B0585A	5.85			6	●
DAS5D2B0590A	5.9			6	●
DAS5D2B0595A	5.95			6	●
DAS5D2B0060A	6.0			6	●
DAS5D2B0605A	6.05	46	90	8	●
DAS5D2B0610A	6.1			8	●
DAS5D2B0615A	6.15			8	●
DAS5D2B0620A	6.2			8	●
DAS5D2B0625A	6.25			8	●
DAS5D2B0630A	6.3			8	●
DAS5D2B0635A	6.35			8	●
DAS5D2B0640A	6.4			8	●
DAS5D2B0645A	6.45			8	●
DAS5D2B0650A	6.5			8	●
DAS5D2B0655A	6.55	49	95	8	●
DAS5D2B0660A	6.6			8	●
DAS5D2B0665A	6.65			8	●
DAS5D2B0670A	6.7			8	●
DAS5D2B0675A	6.75			8	●
DAS5D2B0680A	6.8			8	●
DAS5D2B0685A	6.85			8	●
DAS5D2B0690A	6.9			8	●
DAS5D2B0695A	6.95			8	●
DAS5D2B0070A	7.0			8	●
DAS5D2B0705A	7.05	51	100	8	●
DAS5D2B0710A	7.1			8	●
DAS5D2B0715A	7.15			8	●
DAS5D2B0720A	7.2			8	●
DAS5D2B0725A	7.25			8	●
DAS5D2B0730A	7.3			8	●
DAS5D2B0735A	7.35			8	●
DAS5D2B0740A	7.4			8	●
DAS5D2B0745A	7.45			8	●
DAS5D2B0750A	7.5			8	●
DAS5D2B0755A	7.55	55	100	8	●
DAS5D2B0760A	7.6			8	●
DAS5D2B0765A	7.65			8	●
DAS5D2B0770A	7.7			8	●
DAS5D2B0775A	7.75			8	●
DAS5D2B0780A	7.8			8	●
DAS5D2B0785A	7.85			8	●
DAS5D2B0790A	7.9			8	●
DAS5D2B0795A	7.95			8	●
DAS5D2B0080A	8.0			8	●
DAS5D2B0805A	8.05	58	105	10	●
DAS5D2B0810A	8.1			10	●
DAS5D2B0815A	8.15			10	●
DAS5D2B0820A	8.2			10	●

○: 接單生產品 ●: 在庫品 ▲: 訂製品

鎢鋼鑽頭系列

鎢鋼高速鑽頭×5D  
Carbide High Speed Drill x5D

DAS5D2B

單位:mm(Unit:mm)

刀具料號 Model No.	刃徑 d Diameter	溝長 L Grooving Length	全長 L Overall Length	柄徑 D Shank Diameter	在庫
DAS5D2B0825A	8.25	58	105	10	●
DAS5D2B0830A	8.3			10	●
DAS5D2B0835A	8.35			10	●
DAS5D2B0840A	8.4			10	●
DAS5D2B0845A	8.45			10	●
DAS5D2B0850A	8.5			10	●
DAS5D2B0855A	8.55			10	●
DAS5D2B0860A	8.6	61	110	10	●
DAS5D2B0865A	8.65			10	●
DAS5D2B0870A	8.7			10	●
DAS5D2B0875A	8.75			10	●
DAS5D2B0880A	8.8			10	●
DAS5D2B0885A	8.85			10	●
DAS5D2B0890A	8.9			10	●
DAS5D2B0895A	8.95	10	●		
DAS5D2B0900A	9.0	10	●		
DAS5D2B0905A	9.05	65	115	10	●
DAS5D2B0910A	9.1			10	●
DAS5D2B0915A	9.15			10	●
DAS5D2B0920A	9.2			10	●
DAS5D2B0925A	9.25			10	●
DAS5D2B0930A	9.3			10	●
DAS5D2B0935A	9.35			10	●
DAS5D2B0940A	9.4	10	●		
DAS5D2B0945A	9.45	10	●		
DAS5D2B0950A	9.5	10	●		
DAS5D2B0955A	9.55	68	120	10	●
DAS5D2B0960A	9.6			10	●
DAS5D2B0965A	9.65			10	●
DAS5D2B0970A	9.7			10	●
DAS5D2B0975A	9.75			10	●
DAS5D2B0980A	9.8			10	●
DAS5D2B0985A	9.85			10	●
DAS5D2B0990A	9.9	10	●		
DAS5D2B0995A	9.95	10	●		
DAS5D2B1000A	10.0	10	●		
DAS5D2B1005A	10.05	70	120	12	●
DAS5D2B1010A	10.1			12	●
DAS5D2B1015A	10.15			12	●
DAS5D2B1020A	10.2			12	●
DAS5D2B1025A	10.25			12	●
DAS5D2B1030A	10.3			12	●
DAS5D2B1035A	10.35			12	●
DAS5D2B1040A	10.4	12	●		
DAS5D2B1045A	10.45	12	●		
DAS5D2B1050A	10.5	12	●		
DAS5D2B1055A	10.55	74	125	12	●
DAS5D2B1060A	10.6			12	●
DAS5D2B1065A	10.65			12	●
DAS5D2B1070A	10.7			12	●
DAS5D2B1075A	10.75			12	●
DAS5D2B1080A	10.8			12	●

○: 接單生產品 ●: 在庫品 ▲: 訂製品

# 鎢鋼高速鑽頭×5D

## Carbide High Speed Drill x5D

### DAS5D2B

單位:mm(Unit:mm)

刀具料號 Model No.	刃徑 d Diameter	溝長 L Grooving Length	全長 L Overall Length	柄徑 D Shank Diameter	在庫		
DAS5D2B1085A	10.85	74	125	12	●		
DAS5D2B1090A	10.9			12	●		
DAS5D2B1095A	10.95			12	●		
DAS5D2B1100A	11.0			12	●		
DAS5D2B1105A	11.05	77		12	●		
DAS5D2B1110A	11.1			12	●		
DAS5D2B1115A	11.15			12	●		
DAS5D2B1120A	11.2			12	●		
DAS5D2B1125A	11.25			12	●		
DAS5D2B1130A	11.3			12	●		
DAS5D2B1135A	11.35	80	135	12	●		
DAS5D2B1140A	11.4			12	●		
DAS5D2B1145A	11.45			12	●		
DAS5D2B1150A	11.5			12	●		
DAS5D2B1155A	11.55			12	●		
DAS5D2B1160A	11.6			12	●		
DAS5D2B1165A	11.65			12	●		
DAS5D2B1170A	11.7			12	●		
DAS5D2B1175A	11.75			12	●		
DAS5D2B1180A	11.8			83	140	12	●
DAS5D2B1185A	11.85	12	●				
DAS5D2B1190A	11.9	12	●				
DAS5D2B1195A	11.95	12	●				
DAS5D2B1200A	12.0	12	●				
DAS5D2B1205A	12.05	85	145			13	●
DAS5D2B1210A	12.1					13	●
DAS5D2B1215A	12.15					13	●
DAS5D2B1220A	12.2					13	●
DAS5D2B1225A	12.25					13	●
DAS5D2B1230A	12.3			13	●		
DAS5D2B1235A	12.35			13	●		
DAS5D2B1240A	12.4			13	●		
DAS5D2B1245A	12.45			13	●		
DAS5D2B1250A	12.5			88	145	13	●
DAS5D2B1255A	12.55	13	●				
DAS5D2B1260A	12.6	13	●				
DAS5D2B1265A	12.65	13	●				
DAS5D2B1270A	12.7	13	●				
DAS5D2B1275A	12.75	13	●				
DAS5D2B1280A	12.8	13	●				
DAS5D2B1285A	12.85	13	●				
DAS5D2B1290A	12.9	13	●				
DAS5D2B1295A	12.95	13	●				
DAS5D2B1300A	13.0	88	145	13	●		
DAS5D2B1305A	13.05			14	▲		
DAS5D2B1310A	13.1			14	▲		
DAS5D2B1315A	13.15			14	▲		
DAS5D2B1320A	13.2			14	▲		
DAS5D2B1325A	13.25			14	▲		
DAS5D2B1330A	13.3			14	▲		
DAS5D2B1335A	13.35			14	▲		
DAS5D2B1340A	13.4	14	▲				

○: 接單生產品 ●: 在庫品 ▲: 訂製品

# 鎢鋼高速鑽頭×5D

## Carbide High Speed Drill x5D

### DAS5D2B

單位:mm(Unit:mm)

刀具料號 Model No.	刃徑 d Diameter	溝長 ℓ Grooving Length	全長 L Overall Length	柄徑 D Shank Diameter	在庫		
DAS5D2B1345A	13.45	88	145	14	▲		
DAS5D2B1350A	13.5			●			
DAS5D2B1355A	13.55	91		14	▲		
DAS5D2B1360A	13.6			▲			
DAS5D2B1365A	13.65			▲			
DAS5D2B1370A	13.7			▲			
DAS5D2B1375A	13.75			▲			
DAS5D2B1380A	13.8			▲			
DAS5D2B1385A	13.85			▲			
DAS5D2B1390A	13.9			▲			
DAS5D2B1395A	13.95			▲			
DAS5D2B1400A	14.0			●			
DAS5D2B1405A	14.05	94	150	16	▲		
DAS5D2B1410A	14.1			▲			
DAS5D2B1415A	14.15			▲			
DAS5D2B1420A	14.2			▲			
DAS5D2B1425A	14.25			▲			
DAS5D2B1430A	14.3			▲			
DAS5D2B1435A	14.35			▲			
DAS5D2B1440A	14.4			▲			
DAS5D2B1445A	14.45			▲			
DAS5D2B1450A	14.5			●			
DAS5D2B1455A	14.55			98	155	16	▲
DAS5D2B1460A	14.6					▲	
DAS5D2B1465A	14.65	▲					
DAS5D2B1470A	14.7	▲					
DAS5D2B1475A	14.75	▲					
DAS5D2B1480A	14.8	▲					
DAS5D2B1485A	14.85	▲					
DAS5D2B1490A	14.9	▲					
DAS5D2B1495A	14.95	▲					
DAS5D2B1500A	15.0	●					
DAS5D2B1505A	15.05	100	160			16	▲
DAS5D2B1510A	15.1					▲	
DAS5D2B1515A	15.15			▲			
DAS5D2B1520A	15.2			▲			
DAS5D2B1525A	15.25			▲			
DAS5D2B1530A	15.3			▲			
DAS5D2B1535A	15.35			▲			
DAS5D2B1540A	15.4			▲			
DAS5D2B1545A	15.45			▲			
DAS5D2B1550A	15.5			●			
DAS5D2B1555A	15.55			105	160	16	▲
DAS5D2B1560A	15.6					▲	
DAS5D2B1565A	15.65	▲					
DAS5D2B1570A	15.7	▲					
DAS5D2B1575A	15.75	▲					
DAS5D2B1580A	15.8	▲					
DAS5D2B1585A	15.85	▲					
DAS5D2B1590A	15.9	▲					
DAS5D2B1595A	15.95	▲					
DAS5D2B1600A	16.0	●					

○: 接單生產品    ●: 在庫品    ▲: 訂製品

# 強力鎢鋼油孔鑽頭×3D

## Carbide Drills With Internal Coolant Holes x3D

低碳素鋼 Low Carbon Steels	中碳素鋼 Medium Carbon Steels	高碳素鋼 High Carbon Steels	合金鋼 Alloy Steels	工具鋼 Tool Steels	調質鋼 Hardened Steels	淬火鋼 Quenched and Tempered Steels			鑄鋼 Cast Steels	鑄鐵 Cast Iron	黃銅 Brass	青銅 Bronze	紅銅 Copper	鋁合金 Aluminum Rolled	不銹鋼 Stainless Steels			鈦合金 Titanium Alloys	鎳基合金 Nickel Alloys	碳纖維 Carbon Fiber	玻璃纖維 Glass Fiber	
C0.25%以下	C0.25%~0.45%	C0.45%以上	SCM	SKD	HRC 20~30	HRC 30~40	HRC 40~50	HRC 50~60	SC	FC	FCD	BS	PB	CU	AL	300	400	600	TI			
◎	◎	◎	◎	○	◎	○	○		◎	◎	◎					○	○	○	○	○		

○ 適用 ◎ 專用

特性：

- ◆ 利用特殊刀刃設計,有效降低加工時所產生的阻力,大幅提升刀具穩定性,搭配中心出水的方式,讓鑽頭能夠擁有最好的冷卻效果與極佳的排屑效率。

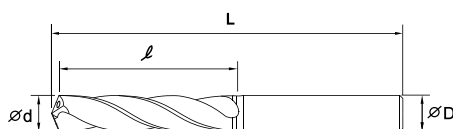

### DAH3D2A

單位:mm(Unit:mm)

刀具料號 Model No.	刃徑 d Diameter	溝長 l Grooving Length	全長 L Overall Length	柄徑 D Shank Diameter	在庫
DAH3D2A0250A	2.5	17	50	4	●
DAH3D2A0255A	2.55			4	●
DAH3D2A0260A	2.6			4	●
DAH3D2A0265A	2.65			4	●
DAH3D2A0270A	2.7			4	●
DAH3D2A0275A	2.75			4	●
DAH3D2A0280A	2.8			4	●
DAH3D2A0285A	2.85			4	●
DAH3D2A0290A	2.9			4	●
DAH3D2A0295A	2.95			4	●
DAH3D2A0030A	3.0	19	55	4	●
DAH3D2A3054A	3.05			4	●
DAH3D2A3104A	3.1			4	●
DAH3D2A3154A	3.15			4	●
DAH3D2A3204A	3.2			4	●
DAH3D2A3254A	3.25			4	●
DAH3D2A3304A	3.3			4	●
DAH3D2A3354A	3.35			4	●
DAH3D2A3404A	3.4			4	●
DAH3D2A3454A	3.45			4	●
DAH3D2A3504A	3.5	22	60	4	●
DAH3D2A3554A	3.55			4	●
DAH3D2A3604A	3.6			4	●
DAH3D2A3654A	3.65			4	●
DAH3D2A3704A	3.7			4	●
DAH3D2A3754A	3.75			4	●
DAH3D2A3804A	3.8			4	●
DAH3D2A3854A	3.85			4	●
DAH3D2A3904A	3.9			4	●
DAH3D2A3954A	3.95			4	●
DAH3D2A4004A	4.0	17	50	4	●
DAH3D2A3006A	3.0			6	●

○: 接單生產品 ●: 在庫品 ▲: 訂製品

# 強力鎢鋼油孔鑽頭×3D

## Carbide Drills With Internal Coolant Holes x3D

### DAH3D2A

單位:mm(Unit:mm)

刀具料號 Model No.	刃徑 d Diameter	溝長 ℓ Grooving Length	全長 L Overall Length	柄徑 D Shank Diameter	在庫
DAH3D2A0305A	3.05	19	55	6	●
DAH3D2A0310A	3.1			6	●
DAH3D2A0315A	3.15			6	●
DAH3D2A0320A	3.2			6	●
DAH3D2A0325A	3.25			6	●
DAH3D2A0330A	3.3			6	●
DAH3D2A0335A	3.35			6	●
DAH3D2A0340A	3.4			6	●
DAH3D2A0345A	3.45			6	●
DAH3D2A0350A	3.5			6	●
DAH3D2A0355A	3.55	22	60	6	●
DAH3D2A0360A	3.6			6	●
DAH3D2A0365A	3.65			6	●
DAH3D2A0370A	3.7			6	●
DAH3D2A0375A	3.75			6	●
DAH3D2A0380A	3.8			6	●
DAH3D2A0385A	3.85			6	●
DAH3D2A0390A	3.9			6	●
DAH3D2A0395A	3.95			6	●
DAH3D2A0404A	4.0			6	●
DAH3D2A0405A	4.05	25	65	6	●
DAH3D2A0410A	4.1			6	●
DAH3D2A0415A	4.15			6	●
DAH3D2A0420A	4.2			6	●
DAH3D2A0425A	4.25			6	●
DAH3D2A0430A	4.3			6	●
DAH3D2A0435A	4.35			6	●
DAH3D2A0440A	4.4			6	●
DAH3D2A0445A	4.45			6	●
DAH3D2A0450A	4.5			6	●
DAH3D2A0455A	4.55	28	65	6	●
DAH3D2A0460A	4.6			6	●
DAH3D2A0465A	4.65			6	●
DAH3D2A0470A	4.7			6	●
DAH3D2A0475A	4.75			6	●
DAH3D2A0480A	4.8			6	●
DAH3D2A0485A	4.85			6	●
DAH3D2A0490A	4.9			6	●
DAH3D2A0495A	4.95			6	●
DAH3D2A0050A	5.0			6	●
DAH3D2A0505A	5.05	30	75	6	●
DAH3D2A0510A	5.1			6	●
DAH3D2A0515A	5.15			6	●
DAH3D2A0520A	5.2			6	●
DAH3D2A0525A	5.25			6	●
DAH3D2A0530A	5.3			6	●
DAH3D2A0535A	5.35			6	●
DAH3D2A0540A	5.4			6	●
DAH3D2A0545A	5.45			6	●
DAH3D2A0550A	5.5			6	●
DAH3D2A0555A	5.55	32	75	6	●
DAH3D2A0560A	5.6			6	●

○: 接單生產 ●: 在庫品 ▲: 訂製品

# 強力鎢鋼油孔鑽頭×3D

## Carbide Drills With Internal Coolant Holes x3D

### DAH3D2A

單位:mm(Unit:mm)

刀具料號 Model No.	刃徑 d Diameter	溝長 $\ell$ Grooving Length	全長 L Overall Length	柄徑 D Shank Diameter	在庫		
DAH3D2A0565A	5.65	32	75	6	●		
DAH3D2A0570A	5.7			6	●		
DAH3D2A0575A	5.75			6	●		
DAH3D2A0580A	5.8			6	●		
DAH3D2A0585A	5.85			6	●		
DAH3D2A0590A	5.9			6	●		
DAH3D2A0595A	5.95			6	●		
DAH3D2A0060A	6.0			6	●		
DAH3D2A0605A	6.05	35	85	8	●		
DAH3D2A0610A	6.1			8	●		
DAH3D2A0615A	6.15			8	●		
DAH3D2A0620A	6.2			8	●		
DAH3D2A0625A	6.25			8	●		
DAH3D2A0630A	6.3			8	●		
DAH3D2A0635A	6.35			8	●		
DAH3D2A0640A	6.4			8	●		
DAH3D2A0645A	6.45			8	●		
DAH3D2A0650A	6.5			8	●		
DAH3D2A0655A	6.55			37	85	8	●
DAH3D2A0660A	6.6					8	●
DAH3D2A0665A	6.65					8	●
DAH3D2A0670A	6.7					8	●
DAH3D2A0675A	6.75					8	●
DAH3D2A0680A	6.8					8	●
DAH3D2A0685A	6.85	8	●				
DAH3D2A0690A	6.9	8	●				
DAH3D2A0695A	6.95	8	●				
DAH3D2A0070A	7.0	8	●				
DAH3D2A0705A	7.05	39	90	8	●		
DAH3D2A0710A	7.1			8	●		
DAH3D2A0715A	7.15			8	●		
DAH3D2A0720A	7.2			8	●		
DAH3D2A0725A	7.25			8	●		
DAH3D2A0730A	7.3			8	●		
DAH3D2A0735A	7.35			8	●		
DAH3D2A0740A	7.4			8	●		
DAH3D2A0745A	7.45			8	●		
DAH3D2A0750A	7.5			8	●		
DAH3D2A0755A	7.55			42	90	8	●
DAH3D2A0760A	7.6					8	●
DAH3D2A0765A	7.65					8	●
DAH3D2A0770A	7.7					8	●
DAH3D2A0775A	7.75	8	●				
DAH3D2A0780A	7.8	8	●				
DAH3D2A0785A	7.85	8	●				
DAH3D2A0790A	7.9	8	●				
DAH3D2A0795A	7.95	8	●				
DAH3D2A0080A	8.0	8	●				
DAH3D2A0805A	8.05	45	95	10	●		
DAH3D2A0810A	8.1			10	●		
DAH3D2A0815A	8.15			10	●		
DAH3D2A0820A	8.2			10	●		

○: 接單生產品 ●: 在庫品 ▲: 訂製品

鎢鋼鑽頭系列



# 強力鎢鋼油孔鑽頭×3D

## Carbide Drills With Internal Coolant Holes x3D

### DAH3D2A

單位:mm(Unit:mm)

刀具料號 Model No.	刃徑 d Diameter	溝長 ℓ Grooving Length	全長 L Overall Length	柄徑 D Shank Diameter	在庫		
DAH3D2A0825A	8.25	45	95	10	●		
DAH3D2A0830A	8.3			10	●		
DAH3D2A0835A	8.35			10	●		
DAH3D2A0840A	8.4			10	●		
DAH3D2A0845A	8.45			10	●		
DAH3D2A0850A	8.5			10	●		
DAH3D2A0855A	8.55			10	●		
DAH3D2A0860A	8.6	47		10	●		
DAH3D2A0865A	8.65			10	●		
DAH3D2A0870A	8.7			10	●		
DAH3D2A0875A	8.75			10	●		
DAH3D2A0880A	8.8			10	●		
DAH3D2A0885A	8.85			10	●		
DAH3D2A0890A	8.9			10	●		
DAH3D2A0895A	8.95	10	●				
DAH3D2A0090A	9.0	10	●				
DAH3D2A0905A	9.05	49	100	10	●		
DAH3D2A0910A	9.1			10	●		
DAH3D2A0915A	9.15			10	●		
DAH3D2A0920A	9.2			10	●		
DAH3D2A0925A	9.25			10	●		
DAH3D2A0930A	9.3			10	●		
DAH3D2A0935A	9.35			10	●		
DAH3D2A0940A	9.4			10	●		
DAH3D2A0945A	9.45			10	●		
DAH3D2A0950A	9.5			10	●		
DAH3D2A0955A	9.55			52	10	●	
DAH3D2A0960A	9.6				10	●	
DAH3D2A0965A	9.65				10	●	
DAH3D2A0970A	9.7				10	●	
DAH3D2A0975A	9.75	10			●		
DAH3D2A0980A	9.8	10			●		
DAH3D2A0985A	9.85	10			●		
DAH3D2A0990A	9.9	10			●		
DAH3D2A0995A	9.95	10			●		
DAH3D2A0100A	10.0	10			●		
DAH3D2A1005A	10.05	54			105	12	●
DAH3D2A1010A	10.1					12	●
DAH3D2A1015A	10.15					12	●
DAH3D2A1020A	10.2					12	●
DAH3D2A1025A	10.25			12		●	
DAH3D2A1030A	10.3			12		●	
DAH3D2A1035A	10.35			12		●	
DAH3D2A1040A	10.4			12		●	
DAH3D2A1045A	10.45		12	●			
DAH3D2A1050A	10.5		12	●			
DAH3D2A1055A	10.55		56	12		●	
DAH3D2A1060A	10.6			12		●	
DAH3D2A1065A	10.65			12		●	
DAH3D2A1070A	10.7			12		●	
DAH3D2A1075A	10.75	12		●			
DAH3D2A1080A	10.8	12		●			

○: 接單生產品    ●: 在庫品    ▲: 訂製品

鎢鋼鑽頭系列

# 強力鎢鋼油孔鑽頭×3D

## Carbide Drills With Internal Coolant Holes x3D

### DAH3D2A

單位:mm(Unit:mm)

刀具料號 Model No.	刃徑 d Diameter	溝長 L Grooving Length	全長 L Overall Length	柄徑 D Shank Diameter	在庫		
DAH3D2A1085A	10.85	56	105	12	●		
DAH3D2A1090A	10.9			12	●		
DAH3D2A1095A	10.95			12	●		
DAH3D2A1100A	11.0			12	●		
DAH3D2A1105A	11.05	58	110	12	●		
DAH3D2A1110A	11.1			12	●		
DAH3D2A1115A	11.15			12	●		
DAH3D2A1120A	11.2			12	●		
DAH3D2A1125A	11.25			12	●		
DAH3D2A1130A	11.3			12	●		
DAH3D2A1135A	11.35			12	●		
DAH3D2A1140A	11.4			12	●		
DAH3D2A1145A	11.45			12	●		
DAH3D2A1150A	11.5			12	●		
DAH3D2A1155A	11.55			60	110	12	●
DAH3D2A1160A	11.6					12	●
DAH3D2A1165A	11.65	12	●				
DAH3D2A1170A	11.7	12	●				
DAH3D2A1175A	11.75	12	●				
DAH3D2A1180A	11.8	12	●				
DAH3D2A1185A	11.85	12	●				
DAH3D2A1190A	11.9	12	●				
DAH3D2A1195A	11.95	12	●				
DAH3D2A1200A	12.0	12	●				
DAH3D2A1205A	12.05	63	115			13	●
DAH3D2A1210A	12.1					13	●
DAH3D2A1215A	12.15			13	●		
DAH3D2A1220A	12.2			13	●		
DAH3D2A1225A	12.25			13	●		
DAH3D2A1230A	12.3			13	●		
DAH3D2A1235A	12.35			13	●		
DAH3D2A1240A	12.4			13	●		
DAH3D2A1245A	12.45			13	●		
DAH3D2A1250A	12.5			13	●		
DAH3D2A1255A	12.55			65	115	13	●
DAH3D2A1260A	12.6					13	●
DAH3D2A1265A	12.65	13	●				
DAH3D2A1270A	12.7	13	●				
DAH3D2A1275A	12.75	13	●				
DAH3D2A1280A	12.8	13	●				
DAH3D2A1285A	12.85	13	●				
DAH3D2A1290A	12.9	13	●				
DAH3D2A1295A	12.95	13	●				
DAH3D2A1300A	13.0	13	●				
DAH3D2A1305A	13.05	68	125			14	▲
DAH3D2A1310A	13.1					14	▲
DAH3D2A1315A	13.15			14	▲		
DAH3D2A1320A	13.2			14	▲		
DAH3D2A1325A	13.25			14	▲		
DAH3D2A1330A	13.3			14	▲		
DAH3D2A1335A	13.35			14	▲		
DAH3D2A1340A	13.4			14	▲		

○: 接單生產品 ●: 在庫品 ▲: 訂製品

# 強力鎢鋼油孔鑽頭×3D

## Carbide Drills With Internal Coolant Holes x3D

### DAH3D2A

單位:mm(Unit:mm)

刀具料號 Model No.	刃徑 d Diameter	溝長 ℓ Grooving Length	全長 L Overall Length	柄徑 D Shank Diameter	在庫	
DAH3D2A1345A	13.45	68	125	14	▲	
DAH3D2A1350A	13.5			●		
DAH3D2A1355A	13.55	70		14	▲	
DAH3D2A1360A	13.6			14	▲	
DAH3D2A1365A	13.65			14	▲	
DAH3D2A1370A	13.7			14	▲	
DAH3D2A1375A	13.75			14	▲	
DAH3D2A1380A	13.8			14	▲	
DAH3D2A1385A	13.85			14	▲	
DAH3D2A1390A	13.9			14	▲	
DAH3D2A1395A	13.95			14	▲	
DAH3D2A1400A	14.0			14	●	
DAH3D2A1405A	14.05	73	130	16	▲	
DAH3D2A1410A	14.1			16	▲	
DAH3D2A1415A	14.15			16	▲	
DAH3D2A1420A	14.2			16	▲	
DAH3D2A1425A	14.25			16	▲	
DAH3D2A1430A	14.3			16	▲	
DAH3D2A1435A	14.35			16	▲	
DAH3D2A1440A	14.4			16	▲	
DAH3D2A1445A	14.45			16	▲	
DAH3D2A1450A	14.5			16	●	
DAH3D2A1455A	14.55			75	16	▲
DAH3D2A1460A	14.6				16	▲
DAH3D2A1465A	14.65				16	▲
DAH3D2A1470A	14.7				16	▲
DAH3D2A1475A	14.75				16	▲
DAH3D2A1480A	14.8				16	▲
DAH3D2A1485A	14.85				16	▲
DAH3D2A1490A	14.9				16	▲
DAH3D2A1495A	14.95	16	▲			
DAH3D2A1500A	15.0	16	●			
DAH3D2A1505A	15.05	78	135		16	▲
DAH3D2A1510A	15.1				16	▲
DAH3D2A1515A	15.15			16	▲	
DAH3D2A1520A	15.2			16	▲	
DAH3D2A1525A	15.25			16	▲	
DAH3D2A1530A	15.3			16	▲	
DAH3D2A1535A	15.35			16	▲	
DAH3D2A1540A	15.4			16	▲	
DAH3D2A1545A	15.45			16	▲	
DAH3D2A1550A	15.5			16	●	
DAH3D2A1555A	15.55			80	16	▲
DAH3D2A1560A	15.6				16	▲
DAH3D2A1565A	15.65				16	▲
DAH3D2A1570A	15.7				16	▲
DAH3D2A1575A	15.75				16	▲
DAH3D2A1580A	15.8				16	▲
DAH3D2A1585A	15.85				16	▲
DAH3D2A1590A	15.9				16	▲
DAH3D2A1595A	15.95	16	▲			
DAH3D2A1600A	16.0	16	●			

○: 接單生產品    ●: 在庫品    ▲: 訂製品

# 強力鎢鋼油孔鑽頭×5D

## Carbide Drills With Internal Coolant Holes x5D

低碳素鋼 Low Carbon Steels	中碳素鋼 Medium Carbon Steels	高碳素鋼 High Carbon Steels	合金鋼 Alloy Steels	工具鋼 Tool Steels	調質鋼 Hardened Steels	淬火鋼 Quenched and Tempered Steels			鑄鋼 Cast Steels	鑄鐵 Cast Iron	黃銅 Brass	青銅 Bronze	紅銅 Copper	鋁合金 Aluminum Rolled	不銹鋼 Stainless Steels			鈦合金 Titanium Alloys	鎳基合金 Nickel Alloys	碳纖維 Carbon Fiber	玻璃纖維 Glass Fiber	
C0.25%以下	C0.25%~0.45%	C0.45%以上	SCM	SKD	HRC 20~30	HRC 30~40	HRC 40~50	HRC 50~60	SC	FC	FCD	BS	PB	CU	AL	300	400	600	TI			
◎	◎	◎	◎	○	◎	○	○		◎	◎	◎					○	○	○	○	○		

○ 適用 ◎ 專用

特性：

- ◆ 利用特殊刀刃設計,有效降低加工時所產生的阻力,大幅提升刀具穩定性,搭配中心出水的方式讓鑽頭能夠擁有最好的冷卻效果與極佳的排屑效率。

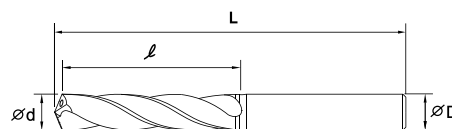

### DAH5D2B

單位:mm(Unit:mm)

刀具料號 Model No.	刃徑 d Diameter	溝長 l Grooving Length	全長 L Overall Length	柄徑 D Shank Diameter	在庫
DAH5D2B0250A	2.5	23	60	4	●
DAH5D2B0255A	2.55			4	●
DAH5D2B0260A	2.6			4	●
DAH5D2B0265A	2.65			4	●
DAH5D2B0270A	2.7			4	●
DAH5D2B0275A	2.75			4	●
DAH5D2B0280A	2.8			4	●
DAH5D2B0285A	2.85			4	●
DAH5D2B0290A	2.9			4	●
DAH5D2B0295A	2.95			4	●
DAH5D2B0030A	3.0	26	65	4	●
DAH5D2B3054A	3.05			4	●
DAH5D2B3104A	3.1			4	●
DAH5D2B3154A	3.15			4	●
DAH5D2B3204A	3.2			4	●
DAH5D2B3254A	3.25			4	●
DAH5D2B3304A	3.3			4	●
DAH5D2B3354A	3.35			4	●
DAH5D2B3404A	3.4			4	●
DAH5D2B3454A	3.45			4	●
DAH5D2B3504A	3.5	30	70	4	●
DAH5D2B3554A	3.55			4	●
DAH5D2B3604A	3.6			4	●
DAH5D2B3654A	3.65			4	●
DAH5D2B3704A	3.7			4	●
DAH5D2B3754A	3.75			4	●
DAH5D2B3804A	3.8			4	●
DAH5D2B3854A	3.85			4	●
DAH5D2B3904A	3.9			4	●
DAH5D2B3954A	3.95			4	●
DAH5D2B4004A	4.0	23	60	4	●
DAH5D2B3006A	3.0			6	●

○: 接單生產品 ●: 在庫品 ▲: 訂製品

# 強力鎢鋼油孔鑽頭×5D

## Carbide Drills With Internal Coolant Holes x5D

### DAH5D2B

單位:mm(Unit:mm)

刀具料號 Model No.	刃徑 d Diameter	溝長 ℓ Grooving Length	全長 L Overall Length	柄徑 D Shank Diameter	在庫
DAH5D2B0305A	3.05	26	65	6	●
DAH5D2B0310A	3.1			6	●
DAH5D2B0315A	3.15			6	●
DAH5D2B0320A	3.2			6	●
DAH5D2B0325A	3.25			6	●
DAH5D2B0330A	3.3			6	●
DAH5D2B0335A	3.35			6	●
DAH5D2B0340A	3.4			6	●
DAH5D2B0345A	3.45			6	●
DAH5D2B0350A	3.5			6	●
DAH5D2B0355A	3.55	30	70	6	●
DAH5D2B0360A	3.6			6	●
DAH5D2B0365A	3.65			6	●
DAH5D2B0370A	3.7			6	●
DAH5D2B0375A	3.75			6	●
DAH5D2B0380A	3.8			6	●
DAH5D2B0385A	3.85			6	●
DAH5D2B0390A	3.9			6	●
DAH5D2B0395A	3.95			6	●
DAH5D2B040A	4.0			6	●
DAH5D2B0405A	4.05	33	75	6	●
DAH5D2B0410A	4.1			6	●
DAH5D2B0415A	4.15			6	●
DAH5D2B0420A	4.2			6	●
DAH5D2B0425A	4.25			6	●
DAH5D2B0430A	4.3			6	●
DAH5D2B0435A	4.35			6	●
DAH5D2B0440A	4.4			6	●
DAH5D2B0445A	4.45			6	●
DAH5D2B0450A	4.5			6	●
DAH5D2B0455A	4.55	38	80	6	●
DAH5D2B0460A	4.6			6	●
DAH5D2B0465A	4.65			6	●
DAH5D2B0470A	4.7			6	●
DAH5D2B0475A	4.75			6	●
DAH5D2B0480A	4.8			6	●
DAH5D2B0485A	4.85			6	●
DAH5D2B0490A	4.9			6	●
DAH5D2B0495A	4.95			6	●
DAH5D2B050A	5.0			6	●
DAH5D2B0505A	5.05	41	85	6	●
DAH5D2B0510A	5.1			6	●
DAH5D2B0515A	5.15			6	●
DAH5D2B0520A	5.2			6	●
DAH5D2B0525A	5.25			6	●
DAH5D2B0530A	5.3			6	●
DAH5D2B0535A	5.35			6	●
DAH5D2B0540A	5.4			6	●
DAH5D2B0545A	5.45			6	●
DAH5D2B0550A	5.5			6	●
DAH5D2B0555A	5.55	44	90	6	●
DAH5D2B0560A	5.6			6	●

○: 接單生產 ●: 在庫品 ▲: 訂製品

# 強力鎢鋼油孔鑽頭×5D

## Carbide Drills With Internal Coolant Holes x5D

### DAH5D2B

單位:mm(Unit:mm)

刀具料號 Model No.	刃徑 d Diameter	溝長 $\ell$ Grooving Length	全長 L Overall Length	柄徑 D Shank Diameter	在庫		
DAH5D2B0565A	5.65	44	90	6	●		
DAH5D2B0570A	5.7			6	●		
DAH5D2B0575A	5.75			6	●		
DAH5D2B0580A	5.8			6	●		
DAH5D2B0585A	5.85			6	●		
DAH5D2B0590A	5.9			6	●		
DAH5D2B0595A	5.95			6	●		
DAH5D2B0060A	6.0			6	●		
DAH5D2B0605A	6.05	48	90	8	●		
DAH5D2B0610A	6.1			8	●		
DAH5D2B0615A	6.15			8	●		
DAH5D2B0620A	6.2			8	●		
DAH5D2B0625A	6.25			8	●		
DAH5D2B0630A	6.3			8	●		
DAH5D2B0635A	6.35			8	●		
DAH5D2B0640A	6.4			8	●		
DAH5D2B0645A	6.45			8	●		
DAH5D2B0650A	6.5			8	●		
DAH5D2B0655A	6.55			51	100	8	●
DAH5D2B0660A	6.6					8	●
DAH5D2B0665A	6.65	8	●				
DAH5D2B0670A	6.7	8	●				
DAH5D2B0675A	6.75	8	●				
DAH5D2B0680A	6.8	8	●				
DAH5D2B0685A	6.85	8	●				
DAH5D2B0690A	6.9	8	●				
DAH5D2B0695A	6.95	8	●				
DAH5D2B0070A	7.0	8	●				
DAH5D2B0705A	7.05	54	100			8	●
DAH5D2B0710A	7.1					8	●
DAH5D2B0715A	7.15					8	●
DAH5D2B0720A	7.2					8	●
DAH5D2B0725A	7.25			8	●		
DAH5D2B0730A	7.3			8	●		
DAH5D2B0735A	7.35			8	●		
DAH5D2B0740A	7.4			8	●		
DAH5D2B0745A	7.45			8	●		
DAH5D2B0750A	7.5			8	●		
DAH5D2B0755A	7.55			58	105	8	●
DAH5D2B0760A	7.6					8	●
DAH5D2B0765A	7.65	8	●				
DAH5D2B0770A	7.7	8	●				
DAH5D2B0775A	7.75	8	●				
DAH5D2B0780A	7.8	8	●				
DAH5D2B0785A	7.85	8	●				
DAH5D2B0790A	7.9	8	●				
DAH5D2B0795A	7.95	8	●				
DAH5D2B0080A	8.0	8	●				
DAH5D2B0805A	8.05	62	110			10	●
DAH5D2B0810A	8.1					10	●
DAH5D2B0815A	8.15			10	●		
DAH5D2B0820A	8.2			10	●		

○: 接單生產品 ●: 在庫品 ▲: 訂製品

# 強力鎢鋼油孔鑽頭×5D

## Carbide Drills With Internal Coolant Holes x5D

### DAH5D2B

單位:mm(Unit:mm)

刀具料號 Model No.	刃徑 d Diameter	溝長 ℓ Grooving Length	全長 L Overall Length	柄徑 D Shank Diameter	在庫
DAH5D2B0825A	8.25	62	110	10	●
DAH5D2B0830A	8.3			10	●
DAH5D2B0835A	8.35			10	●
DAH5D2B0840A	8.4			10	●
DAH5D2B0845A	8.45			10	●
DAH5D2B0850A	8.5			10	●
DAH5D2B0855A	8.55			10	●
DAH5D2B0860A	8.6	65	115	10	●
DAH5D2B0865A	8.65			10	●
DAH5D2B0870A	8.7			10	●
DAH5D2B0875A	8.75			10	●
DAH5D2B0880A	8.8			10	●
DAH5D2B0885A	8.85			10	●
DAH5D2B0890A	8.9			10	●
DAH5D2B0895A	8.95	10	●		
DAH5D2B0900A	9.0	10	●		
DAH5D2B0905A	9.05	68	120	10	●
DAH5D2B0910A	9.1			10	●
DAH5D2B0915A	9.15			10	●
DAH5D2B0920A	9.2			10	●
DAH5D2B0925A	9.25			10	●
DAH5D2B0930A	9.3			10	●
DAH5D2B0935A	9.35			10	●
DAH5D2B0940A	9.4	10	●		
DAH5D2B0945A	9.45	10	●		
DAH5D2B0950A	9.5	10	●		
DAH5D2B0955A	9.55	72	125	10	●
DAH5D2B0960A	9.6			10	●
DAH5D2B0965A	9.65			10	●
DAH5D2B0970A	9.7			10	●
DAH5D2B0975A	9.75			10	●
DAH5D2B0980A	9.8			10	●
DAH5D2B0985A	9.85			10	●
DAH5D2B0990A	9.9	10	●		
DAH5D2B0995A	9.95	10	●		
DAH5D2B1000A	10.0	10	●		
DAH5D2B1005A	10.05	75	125	12	●
DAH5D2B1010A	10.1			12	●
DAH5D2B1015A	10.15			12	●
DAH5D2B1020A	10.2			12	●
DAH5D2B1025A	10.25			12	●
DAH5D2B1030A	10.3			12	●
DAH5D2B1035A	10.35			12	●
DAH5D2B1040A	10.4	12	●		
DAH5D2B1045A	10.45	12	●		
DAH5D2B1050A	10.5	12	●		
DAH5D2B1055A	10.55	78	130	12	●
DAH5D2B1060A	10.6			12	●
DAH5D2B1065A	10.65			12	●
DAH5D2B1070A	10.7			12	●
DAH5D2B1075A	10.75			12	●
DAH5D2B1080A	10.8			12	●

○: 接單生產品    ●: 在庫品    ▲: 訂製品

鎢鋼鑽頭系列

# 強力鎢鋼油孔鑽頭×5D

## Carbide Drills With Internal Coolant Holes x5D

### DAH5D2B

單位:mm(Unit:mm)

刀具料號 Model No.	刃徑 d Diameter	溝長 L Grooving Length	全長 L Overall Length	柄徑 D Shank Diameter	在庫
DAH5D2B1085A	10.85	78	130	12	●
DAH5D2B1090A	10.9			12	●
DAH5D2B1095A	10.95			12	●
DAH5D2B1100A	11.0			12	●
DAH5D2B1105A	11.05	81		12	●
DAH5D2B1110A	11.1			12	●
DAH5D2B1115A	11.15			12	●
DAH5D2B1120A	11.2			12	●
DAH5D2B1125A	11.25			12	●
DAH5D2B1130A	11.3			12	●
DAH5D2B1135A	11.35			12	●
DAH5D2B1140A	11.4	12	●		
DAH5D2B1145A	11.45	12	●		
DAH5D2B1150A	11.5	12	●		
DAH5D2B1155A	11.55	84	140	12	●
DAH5D2B1160A	11.6			12	●
DAH5D2B1165A	11.65			12	●
DAH5D2B1170A	11.7			12	●
DAH5D2B1175A	11.75			12	●
DAH5D2B1180A	11.8			12	●
DAH5D2B1185A	11.85			12	●
DAH5D2B1190A	11.9			12	●
DAH5D2B1195A	11.95			12	●
DAH5D2B1200A	12.0			12	●
DAH5D2B1205A	12.05			88	13
DAH5D2B1210A	12.1	13			●
DAH5D2B1215A	12.15	13			●
DAH5D2B1220A	12.2	13			●
DAH5D2B1225A	12.25	13	●		
DAH5D2B1230A	12.3	13	●		
DAH5D2B1235A	12.35	13	●		
DAH5D2B1240A	12.4	13	●		
DAH5D2B1245A	12.45	13	●		
DAH5D2B1250A	12.5	13	●		
DAH5D2B1255A	12.55	91	145		13
DAH5D2B1260A	12.6			13	●
DAH5D2B1265A	12.65			13	●
DAH5D2B1270A	12.7			13	●
DAH5D2B1275A	12.75			13	●
DAH5D2B1280A	12.8			13	●
DAH5D2B1285A	12.85			13	●
DAH5D2B1290A	12.9			13	●
DAH5D2B1295A	12.95			13	●
DAH5D2B1300A	13.0			13	●
DAH5D2B1305A	13.05			95	14
DAH5D2B1310A	13.1	14			▲
DAH5D2B1315A	13.15	14			▲
DAH5D2B1320A	13.2	14			▲
DAH5D2B1325A	13.25	14			▲
DAH5D2B1330A	13.3	14			▲
DAH5D2B1335A	13.35	14			▲
DAH5D2B1340A	13.4	14	▲		

○: 接單生產品 ●: 在庫品 ▲: 訂製品



# 強力鎢鋼油孔鑽頭×5D

## Carbide Drills With Internal Coolant Holes x5D

### DAH5D2B

單位:mm(Unit:mm)

刀具料號 Model No.	刃徑 d Diameter	溝長 ℓ Grooving Length	全長 L Overall Length	柄徑 D Shank Diameter	在庫		
DAH5D2B1345A	13.45	95	145	14	▲		
DAH5D2B1350A	13.5			14	●		
DAH5D2B1355A	13.55	98	150	14	▲		
DAH5D2B1360A	13.6			14	▲		
DAH5D2B1365A	13.65			14	▲		
DAH5D2B1370A	13.7			14	▲		
DAH5D2B1375A	13.75			14	▲		
DAH5D2B1380A	13.8			14	▲		
DAH5D2B1385A	13.85			14	▲		
DAH5D2B1390A	13.9			14	▲		
DAH5D2B1395A	13.95			14	▲		
DAH5D2B1400A	14.0			14	●		
DAH5D2B1405A	14.05			101	150	16	▲
DAH5D2B1410A	14.1					16	▲
DAH5D2B1415A	14.15	16	▲				
DAH5D2B1420A	14.2	16	▲				
DAH5D2B1425A	14.25	16	▲				
DAH5D2B1430A	14.3	16	▲				
DAH5D2B1435A	14.35	16	▲				
DAH5D2B1440A	14.4	16	▲				
DAH5D2B1445A	14.45	16	▲				
DAH5D2B1450A	14.5	16	●				
DAH5D2B1455A	14.55	105	160			16	▲
DAH5D2B1460A	14.6					16	▲
DAH5D2B1465A	14.65			16	▲		
DAH5D2B1470A	14.7			16	▲		
DAH5D2B1475A	14.75			16	▲		
DAH5D2B1480A	14.8			16	▲		
DAH5D2B1485A	14.85			16	▲		
DAH5D2B1490A	14.9			16	▲		
DAH5D2B1495A	14.95			16	▲		
DAH5D2B1500A	15.0			16	●		
DAH5D2B1505A	15.05			108	160	16	▲
DAH5D2B1510A	15.1					16	▲
DAH5D2B1515A	15.15	16	▲				
DAH5D2B1520A	15.2	16	▲				
DAH5D2B1525A	15.25	16	▲				
DAH5D2B1530A	15.3	16	▲				
DAH5D2B1535A	15.35	16	▲				
DAH5D2B1540A	15.4	16	▲				
DAH5D2B1545A	15.45	16	▲				
DAH5D2B1550A	15.5	16	●				
DAH5D2B1555A	15.55	112	165			16	▲
DAH5D2B1560A	15.6					16	▲
DAH5D2B1565A	15.65			16	▲		
DAH5D2B1570A	15.7			16	▲		
DAH5D2B1575A	15.75			16	▲		
DAH5D2B1580A	15.8			16	▲		
DAH5D2B1585A	15.85			16	▲		
DAH5D2B1590A	15.9			16	▲		
DAH5D2B1595A	15.95			16	▲		
DAH5D2B1600A	16.0			16	●		

○: 接單生產品    ●: 在庫品    ▲: 訂製品

鎢鋼鑽頭系列

# 加強型鎢鋼鑽絞刀×3D Reinforced Carbide Drill Reamer x3D

低碳素鋼 Low Carbon Steels	中碳素鋼 Medium Carbon Steels	高碳素鋼 High Carbon Steels	合金鋼 Alloy Steels	工具鋼 Tool Steels	調質鋼 Hardened Steels	淬火鋼 Quenched and Tempered Steels			鑄鋼 Cast Steels	鑄鐵 Cast Iron	黃銅 Brass	青銅 Bronze	紅銅 Copper	鋁合金 Aluminum Rolled	不銹鋼 Stainless Steels			鈦合金 Titanium Alloys	鎳基合金 Nickel Alloys	碳纖維 Carbon Fiber	玻璃纖維 Glass Fiber	
C0.25%以下	C0.25%~0.45%	C0.45%以上	SCM	SKD	HRC 20~30	HRC 30~40	HRC 40~50	HRC 50~60	SC	FC	FCD	BS	PB	CU	AL	300	400	600	TI			
◎	◎	◎	○	○	○	○	○	○	○	◎	○						○	○				

○ 適用 ◎ 專用

◆ 特性：增加副刃，有效延長刀具使用壽命。

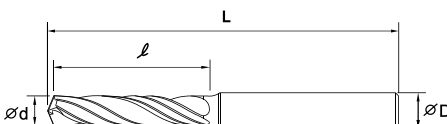

## DRS3D2A

單位:mm(Unit:mm)

刀具料號 Model No.	刃徑 d Diameter	溝長 l Grooving Length	全長 L Overall Length	柄徑 D Shank Diameter	在庫
DRS3D2A0030A	3.0	16	50	4	○
DRS3D2A0310A	3.1			6	○
DRS3D2A0320A	3.2			6	○
DRS3D2A0330A	3.3	18	55	6	●
DRS3D2A0335A	3.35			6	●
DRS3D2A0340A	3.4			6	●
DRS3D2A0350A	3.5			6	○
DRS3D2A0360A	3.6			6	○
DRS3D2A0370A	3.7			6	○
DRS3D2A0380A	3.8	21	60	6	○
DRS3D2A0390A	3.9			6	○
DRS3D2A0040A	4.0			6	○
DRS3D2A0410A	4.1			6	○
DRS3D2A0420A	4.2			6	●
DRS3D2A0425A	4.25	23		6	●
DRS3D2A0430A	4.3			6	●
DRS3D2A0440A	4.4			6	○
DRS3D2A0450A	4.5		65	6	○
DRS3D2A0460A	4.6			6	○
DRS3D2A0470A	4.7			6	○
DRS3D2A0480A	4.8	26		6	○
DRS3D2A0490A	4.9			6	○
DRS3D2A0050A	5.0			6	●
DRS3D2A0505A	5.05			6	●
DRS3D2A0510A	5.1			6	●
DRS3D2A0520A	5.2	29		6	○
DRS3D2A0530A	5.3			6	○
DRS3D2A0540A	5.4			6	○
DRS3D2A0550A	5.5		70	6	○
DRS3D2A0560A	5.6			6	○
DRS3D2A0570A	5.7			6	○
DRS3D2A0580A	5.8	30		6	○
DRS3D2A0590A	5.9			6	○
DRS3D2A0060A	6.0			6	○
DRS3D2A0610A	6.1	33	75	8	○

○：接單生產品 ●：在庫品 ▲：訂製品

# 加強型鎢鋼鑽絞刀×3D

## Reinforced Carbide Drill Reamer x3D

### DRS3D2A

單位:mm(Unit:mm)

刀具料號 Model No.	刃徑 d Diameter	溝長 ℓ Grooving Length	全長 L Overall Length	柄徑 D Shank Diameter	在庫
DRS3D2A0620A	6.2	33	75	8	○
DRS3D2A0630A	6.3			8	○
DRS3D2A0640A	6.4			8	○
DRS3D2A0650A	6.5			8	○
DRS3D2A0660A	6.6	35	80	8	○
DRS3D2A0670A	6.7			8	○
DRS3D2A0675A	6.75			8	●
DRS3D2A0680A	6.8			8	●
DRS3D2A0685A	6.85			8	●
DRS3D2A0690A	6.9			8	○
DRS3D2A0070A	7.0	36	80	8	○
DRS3D2A0710A	7.1			8	○
DRS3D2A0720A	7.2			8	○
DRS3D2A0730A	7.3			8	○
DRS3D2A0740A	7.4			8	○
DRS3D2A0750A	7.5			8	○
DRS3D2A0760A	7.6	38	85	8	○
DRS3D2A0770A	7.7			8	○
DRS3D2A0780A	7.8			8	○
DRS3D2A0790A	7.9			8	○
DRS3D2A0080A	8.0			8	○
DRS3D2A0810A	8.1			41	85
DRS3D2A0820A	8.2	10	○		
DRS3D2A0830A	8.3	10	○		
DRS3D2A0840A	8.4	10	○		
DRS3D2A0850A	8.5	10	●		
DRS3D2A0855A	8.55	10	●		
DRS3D2A0860A	8.6	43	90	10	●
DRS3D2A0870A	8.7			10	○
DRS3D2A0880A	8.8			10	○
DRS3D2A0890A	8.9			10	○
DRS3D2A0090A	9.0			10	○
DRS3D2A0910A	9.1			46	90
DRS3D2A0920A	9.2	10	○		
DRS3D2A0930A	9.3	10	○		
DRS3D2A0940A	9.4	10	○		
DRS3D2A0950A	9.5	10	○		
DRS3D2A0960A	9.6	47	95		
DRS3D2A0970A	9.7			10	○
DRS3D2A0980A	9.8			10	○
DRS3D2A0990A	9.9			10	○
DRS3D2A0100A	10.0			10	○
DRS3D2A1010A	10.1			49	95
DRS3D2A1020A	10.2	12	○		
DRS3D2A1025A	10.25	12	●		
DRS3D2A1030A	10.3	12	●		
DRS3D2A1035A	10.35	12	●		
DRS3D2A1040A	10.4	12	●		
DRS3D2A1050A	10.5	12	●		
DRS3D2A1060A	10.6	51	105	12	○
DRS3D2A1070A	10.7			12	○
DRS3D2A1080A	10.8			12	○

○: 接單生產品    ●: 在庫品    ▲: 訂製品

# 加強型鎢鋼鑽絞刀×3D

## Reinforced Carbide Drill Reamer x3D

### DRS3D2A

單位:mm(Unit:mm)

刀具料號 Model No.	刃徑 d Diameter	溝長 ℓ Grooving Length	全長 L Overall Length	柄徑 D Shank Diameter	在庫			
DRS3D2A1090A	10.9	51	105	12	○			
DRS3D2A1100A	11.0			12	○			
DRS3D2A1110A	11.1	54		12	○			
DRS3D2A1120A	11.2			12	○			
DRS3D2A1130A	11.3			12	○			
DRS3D2A1140A	11.4			12	○			
DRS3D2A1150A	11.5	55		12	○			
DRS3D2A1160A	11.6			12	○			
DRS3D2A1170A	11.7			12	○			
DRS3D2A1180A	11.8			12	○			
DRS3D2A1190A	11.9	58	110	12	○			
DRS3D2A1200A	12.0			12	○			
DRS3D2A1210A	12.1			60	115	13	○	
DRS3D2A1220A	12.2					13	○	
DRS3D2A1230A	12.3					13	○	
DRS3D2A1240A	12.4					13	○	
DRS3D2A1250A	12.5					13	○	
DRS3D2A1260A	12.6					13	○	
DRS3D2A1270A	12.7					13	○	
DRS3D2A1280A	12.8					13	○	
DRS3D2A1290A	12.9	13	○					
DRS3D2A1300A	13.0	62	120			13	○	
DRS3D2A1310A	13.1			64	125	14	○	
DRS3D2A1320A	13.2					14	○	
DRS3D2A1330A	13.3					14	○	
DRS3D2A1340A	13.4					14	○	
DRS3D2A1350A	13.5					14	○	
DRS3D2A1360A	13.6					66	14	○
DRS3D2A1370A	13.7						14	○
DRS3D2A1380A	13.8						14	○
DRS3D2A1390A	13.9						14	○
DRS3D2A1400A	14.0	67	125			14	○	
DRS3D2A1410A	14.1			70	16	○		
DRS3D2A1420A	14.2				16	○		
DRS3D2A1430A	14.3				16	○		
DRS3D2A1440A	14.4				16	○		
DRS3D2A1450A	14.5				16	○		
DRS3D2A1460A	14.6				66	16	○	
DRS3D2A1470A	14.7					16	○	
DRS3D2A1480A	14.8					16	○	
DRS3D2A1490A	14.9					16	○	
DRS3D2A1500A	15.0	67	125		16	○		
DRS3D2A1510A	15.1			16	○			
DRS3D2A1520A	15.2			16	○			
DRS3D2A1530A	15.3			16	○			
DRS3D2A1540A	15.4			16	○			
DRS3D2A1550A	15.5	70	125	16	○			
DRS3D2A1560A	15.6			16	○			
DRS3D2A1570A	15.7			16	○			
DRS3D2A1580A	15.8			16	○			
DRS3D2A1590A	15.9			16	○			
DRS3D2A1600A	16.0			16	○			

○: 接單生產品 ●: 在庫品 ▲: 訂製品

鎢鋼鑽頭系列

# 加強型鎢鋼鑽絞刀×5D

## Reinforced Carbide Drill Reamer x5D

低碳素鋼 Low Carbon Steels	中碳素鋼 Medium Carbon Steels	高碳素鋼 High Carbon Steels	合金鋼 Alloy Steels	工具鋼 Tool Steels	調質鋼 Hardened Steels	淬火鋼 Quenched and Tempered Steels			鑄鋼 Cast Steels	鑄鐵 Cast Iron			黃銅 Brass	青銅 Bronze	紅銅 Copper	鋁合金 Aluminum Rolled	不銹鋼 Stainless Steels			鈦合金 Titanium Alloys	鎳基合金 Nickel Alloys	碳纖維 Carbon Fiber	玻璃纖維 Glass Fiber
						HRC 20~30	HRC 30~40	HRC 40~50		HRC 50~60	SC	FC					FCD	BS	PB				
CO.25%以下	CO.25%~0.45%	CO.45%以上	SCM	SKD	HRC 20~30	HRC 30~40	HRC 40~50	HRC 50~60	SC	FC	FCD	BS	PB	CU	AL	300	400	600	TI				
○	◎	◎	○	○	○	○	○		○	◎	○						○	○					

○ 適用 ◎ 專用

◆ 特性：增加副刃・有效延長刀具使用壽命。

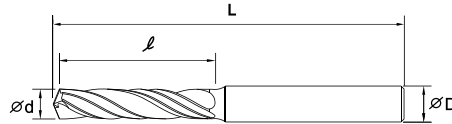

## DRS5D2B

單位:mm(Unit:mm)

刀具料號 Model No.	刃徑 d Diameter	溝長 l Grooving Length	全長 L Overall Length	柄徑 D Shank Diameter	在庫
DRS5D2B0030A	3.0	22	60	4	○
DRS5D2B0310A	3.1			6	○
DRS5D2B0320A	3.2			6	○
DRS5D2B0330A	3.3	25	65	6	●
DRS5D2B0335A	3.35			6	●
DRS5D2B0340A	3.4			6	●
DRS5D2B0350A	3.5			6	○
DRS5D2B0360A	3.6			6	○
DRS5D2B0370A	3.7			6	○
DRS5D2B0380A	3.8	29	70	6	○
DRS5D2B0390A	3.9			6	○
DRS5D2B0040A	4.0			6	○
DRS5D2B0410A	4.1			6	○
DRS5D2B0420A	4.2			6	●
DRS5D2B0425A	4.25	32	75	6	●
DRS5D2B0430A	4.3			6	●
DRS5D2B0440A	4.4			6	○
DRS5D2B0450A	4.5			6	○
DRS5D2B0460A	4.6			6	○
DRS5D2B0470A	4.7			6	○
DRS5D2B0480A	4.8	36	80	6	○
DRS5D2B0490A	4.9			6	○
DRS5D2B0050A	5.0			6	●
DRS5D2B0505A	5.05			6	●
DRS5D2B0510A	5.1			6	●
DRS5D2B0520A	5.2	40	85	6	○
DRS5D2B0530A	5.3			6	○
DRS5D2B0540A	5.4			6	○
DRS5D2B0550A	5.5			6	○
DRS5D2B0560A	5.6			6	○
DRS5D2B0570A	5.7			6	○
DRS5D2B0580A	5.8	42	90	6	○
DRS5D2B0590A	5.9			6	○
DRS5D2B0060A	6.0			6	○
DRS5D2B0610A	6.1	46		8	○

○: 接單生產 ●: 在庫品 ▲: 訂製品

# 加強型鎢鋼鑽絞刀×5D

## Reinforced Carbide Drill Reamer x5D

### DRS5D2B

單位:mm(Unit:mm)

刀具料號 Model No.	刃徑 d Diameter	溝長 ℓ Grooving Length	全長 L Overall Length	柄徑 D Shank Diameter	在庫		
DRS5D2B0620A	6.2	46	90	8	○		
DRS5D2B0630A	6.3			8	○		
DRS5D2B0640A	6.4			8	○		
DRS5D2B0650A	6.5			8	○		
DRS5D2B0660A	6.6	49	95	8	○		
DRS5D2B0670A	6.7			8	○		
DRS5D2B0675A	6.75			8	●		
DRS5D2B0680A	6.8			8	●		
DRS5D2B0685A	6.85			8	●		
DRS5D2B0690A	6.9			8	○		
DRS5D2B0070A	7.0	51	100	8	○		
DRS5D2B0710A	7.1			8	○		
DRS5D2B0720A	7.2			8	○		
DRS5D2B0730A	7.3			8	○		
DRS5D2B0740A	7.4			8	○		
DRS5D2B0750A	7.5			8	○		
DRS5D2B0760A	7.6			55	8	○	
DRS5D2B0770A	7.7				8	○	
DRS5D2B0780A	7.8				8	○	
DRS5D2B0790A	7.9				8	○	
DRS5D2B0080A	8.0	8	○				
DRS5D2B0810A	8.1	58	105	10	○		
DRS5D2B0820A	8.2			10	○		
DRS5D2B0830A	8.3			10	○		
DRS5D2B0840A	8.4			10	○		
DRS5D2B0850A	8.5			10	●		
DRS5D2B0855A	8.55			10	●		
DRS5D2B0860A	8.6			10	●		
DRS5D2B0870A	8.7	61	110	10	○		
DRS5D2B0880A	8.8			10	○		
DRS5D2B0890A	8.9			10	○		
DRS5D2B0090A	9.0			10	○		
DRS5D2B0910A	9.1			65	115	10	○
DRS5D2B0920A	9.2					10	○
DRS5D2B0930A	9.3	10	○				
DRS5D2B0940A	9.4	10	○				
DRS5D2B0950A	9.5	10	○				
DRS5D2B0960A	9.6	68	120			10	○
DRS5D2B0970A	9.7					10	○
DRS5D2B0980A	9.8			10	○		
DRS5D2B0990A	9.9			10	○		
DRS5D2B0100A	10.0			10	○		
DRS5D2B1010A	10.1			70	12	○	
DRS5D2B1020A	10.2				12	○	
DRS5D2B1025A	10.25				12	●	
DRS5D2B1030A	10.3				12	●	
DRS5D2B1035A	10.35				12	●	
DRS5D2B1040A	10.4	12	●				
DRS5D2B1050A	10.5	12	●				
DRS5D2B1060A	10.6	74	125		12	○	
DRS5D2B1070A	10.7			12	○		
DRS5D2B1080A	10.8			12	○		

○: 接單生產品    ●: 在庫品    ▲: 訂製品

鎢鋼鑽頭系列

# 加強型鎢鋼鑽絞刀×5D

## Reinforced Carbide Drill Reamer x5D

### DRS5D2B

單位:mm(Unit:mm)

刀具料號 Model No.	刃徑 d Diameter	溝長 L Grooving Length	全長 L Overall Length	柄徑 D Shank Diameter	在庫
DRS5D2B1090A	10.9	74	125	12	○
DRS5D2B1100A	11.0			12	○
DRS5D2B1110A	11.1	77		12	○
DRS5D2B1120A	11.2			12	○
DRS5D2B1130A	11.3			12	○
DRS5D2B1140A	11.4			12	○
DRS5D2B1150A	11.5	80	12	○	
DRS5D2B1160A	11.6		12	○	
DRS5D2B1170A	11.7		12	○	
DRS5D2B1180A	11.8		12	○	
DRS5D2B1190A	11.9		12	○	
DRS5D2B1200A	12.0		83	12	○
DRS5D2B1210A	12.1	13		○	
DRS5D2B1220A	12.2	13		○	
DRS5D2B1230A	12.3	13		○	
DRS5D2B1240A	12.4	13		○	
DRS5D2B1250A	12.5	13		○	
DRS5D2B1260A	12.6	85	13	○	
DRS5D2B1270A	12.7		13	○	
DRS5D2B1280A	12.8		13	○	
DRS5D2B1290A	12.9		13	○	
DRS5D2B1300A	13.0		13	○	
DRS5D2B1310A	13.1		88	14	○
DRS5D2B1320A	13.2	14		○	
DRS5D2B1330A	13.3	14		○	
DRS5D2B1340A	13.4	14		○	
DRS5D2B1350A	13.5	14		○	
DRS5D2B1360A	13.6	91		14	○
DRS5D2B1370A	13.7		14	○	
DRS5D2B1380A	13.8		14	○	
DRS5D2B1390A	13.9		14	○	
DRS5D2B1400A	14.0		14	○	
DRS5D2B1410A	14.1		94	16	○
DRS5D2B1420A	14.2	16		○	
DRS5D2B1430A	14.3	16		○	
DRS5D2B1440A	14.4	16		○	
DRS5D2B1450A	14.5	16		○	
DRS5D2B1460A	14.6	98		16	○
DRS5D2B1470A	14.7		16	○	
DRS5D2B1480A	14.8		16	○	
DRS5D2B1490A	14.9		16	○	
DRS5D2B1500A	15.0		100	16	○
DRS5D2B1510A	15.1			16	○
DRS5D2B1520A	15.2	16		○	
DRS5D2B1530A	15.3	16		○	
DRS5D2B1540A	15.4	16		○	
DRS5D2B1550A	15.5	105		16	○
DRS5D2B1560A	15.6		16	○	
DRS5D2B1570A	15.7		16	○	
DRS5D2B1580A	15.8		16	○	
DRS5D2B1590A	15.9		16	○	
DRS5D2B1600A	16.0		16	○	

○: 接單生產品   ●: 在庫品   ▲: 訂製品

# 加強型鎢鋼油孔鑽鉸刀×3D

## Reinforced Carbide Drill Reamer With Internal Coolant Holes x3D

低碳素鋼 Low Carbon Steels	中碳素鋼 Medium Carbon Steels	高碳素鋼 High Carbon Steels	合金鋼 Alloy Steels	工具鋼 Tool Steels	調質鋼 Hardened Steels	淬火鋼 Quenched and Tempered Steels			鑄鋼 Cast Steels	鑄鐵 Cast Iron	黃銅 Brass	青銅 Bronze	紅銅 Copper	鋁合金 Aluminum Rolled	不銹鋼 Stainless Steels			鈦合金 Titanium Alloys	鎳基合金 Nickel Alloys	碳纖維 Carbon Fiber	玻璃纖維 Glass Fiber	
C0.25%以下	C0.25%~0.45%	C0.45%以上	SCM	SKD	HRC 20~30	HRC 30~40	HRC 40~50	HRC 50~60	SC	FC	FCD	BS	PB	CU	AL	300	400	600	TI			
◎	◎	◎	◎	○	◎	○	○		◎	◎	◎					○	○	○	○	○		

○ 適用 ◎ 專用

◆ 特性：增加副刃，有效延長刀具使用壽命，搭配中心出水的方式使排屑效率及冷卻效果極佳。

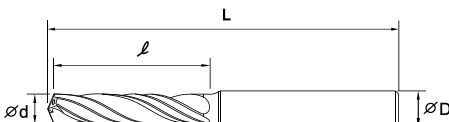

### DRH3D2A

單位:mm(Unit:mm)

刀具料號 Model No.	刃徑 d Diameter	溝長 l Grooving Length	全長 L Overall Length	柄徑 D Shank Diameter	在庫
DRH3D2A0030A	3.0	17	50	4	○
DRH3D2A0310A	3.1			6	○
DRH3D2A0320A	3.2			6	○
DRH3D2A0330A	3.3	19	55	6	●
DRH3D2A0335A	3.35			6	●
DRH3D2A0340A	3.4			6	●
DRH3D2A0350A	3.5			6	○
DRH3D2A0360A	3.6			6	○
DRH3D2A0370A	3.7			6	○
DRH3D2A0380A	3.8	22	60	6	○
DRH3D2A0390A	3.9			6	○
DRH3D2A0040A	4.0			6	○
DRH3D2A0410A	4.1			6	○
DRH3D2A0420A	4.2			6	●
DRH3D2A0425A	4.25	25		6	●
DRH3D2A0430A	4.3			6	●
DRH3D2A0440A	4.4			6	○
DRH3D2A0450A	4.5		65	6	○
DRH3D2A0460A	4.6			6	○
DRH3D2A0470A	4.7			6	○
DRH3D2A0480A	4.8	28		6	○
DRH3D2A0490A	4.9			6	○
DRH3D2A0050A	5.0			6	●
DRH3D2A0505A	5.05			6	●
DRH3D2A0510A	5.1			6	●
DRH3D2A0520A	5.2	30		6	○
DRH3D2A0530A	5.3			6	○
DRH3D2A0540A	5.4			6	○
DRH3D2A0550A	5.5		75	6	○
DRH3D2A0560A	5.6			6	○
DRH3D2A0570A	5.7			6	○
DRH3D2A0580A	5.8	32		6	○
DRH3D2A0590A	5.9			6	○
DRH3D2A0060A	6.0			6	○
DRH3D2A0610A	6.1	35	85	8	○

○：接單生產品 ●：在庫品 ▲：訂製品



# 加強型鎢鋼油孔鑽絞刀×3D

Reinforced Carbide Drill Reamer With Internal Coolant Holes x3D

## DRH3D2A

單位:mm(Unit:mm)

刀具料號 Model No.	刃徑 d Diameter	溝長 ℓ Grooving Length	全長 L Overall Length	柄徑 D Shank Diameter	在庫	
DRH3D2A0620A	6.2	35	85	8	○	
DRH3D2A0630A	6.3			8	○	
DRH3D2A0640A	6.4			8	○	
DRH3D2A0650A	6.5			8	○	
DRH3D2A0660A	6.6			8	○	
DRH3D2A0670A	6.7	37		8	○	
DRH3D2A0675A	6.75			8	●	
DRH3D2A0680A	6.8			8	●	
DRH3D2A0685A	6.85			8	●	
DRH3D2A0690A	6.9			8	○	
DRH3D2A0070A	7.0	90	8	○		
DRH3D2A0710A	7.1		8	○		
DRH3D2A0720A	7.2		8	○		
DRH3D2A0730A	7.3		8	○		
DRH3D2A0740A	7.4		8	○		
DRH3D2A0750A	7.5		8	○		
DRH3D2A0760A	7.6		42	8	○	
DRH3D2A0770A	7.7			8	○	
DRH3D2A0780A	7.8			8	○	
DRH3D2A0790A	7.9			8	○	
DRH3D2A0080A	8.0	8		○		
DRH3D2A0810A	8.1	45	95	10	○	
DRH3D2A0820A	8.2			10	○	
DRH3D2A0830A	8.3			10	○	
DRH3D2A0840A	8.4			10	○	
DRH3D2A0850A	8.5			10	●	
DRH3D2A0855A	8.55			10	●	
DRH3D2A0860A	8.6			47	10	●
DRH3D2A0870A	8.7				10	○
DRH3D2A0880A	8.8				10	○
DRH3D2A0890A	8.9				10	○
DRH3D2A0090A	9.0	10	○			
DRH3D2A0910A	9.1	49	100	10	○	
DRH3D2A0920A	9.2			10	○	
DRH3D2A0930A	9.3			10	○	
DRH3D2A0940A	9.4			10	○	
DRH3D2A0950A	9.5			10	○	
DRH3D2A0960A	9.6			52	10	○
DRH3D2A0970A	9.7				10	○
DRH3D2A0980A	9.8				10	○
DRH3D2A0990A	9.9				10	○
DRH3D2A0100A	10.0				10	○
DRH3D2A1010A	10.1	54	105	12	○	
DRH3D2A1020A	10.2			12	○	
DRH3D2A1025A	10.25			12	●	
DRH3D2A1030A	10.3			12	●	
DRH3D2A1035A	10.35			12	●	
DRH3D2A1040A	10.4			12	●	
DRH3D2A1050A	10.5			12	●	
DRH3D2A1060A	10.6			56	12	○
DRH3D2A1070A	10.7				12	○
DRH3D2A1080A	10.8				12	○

○: 接單生產品    ●: 在庫品    ▲: 訂製品

# 加強型鎢鋼油孔鑽絞刀×3D

Reinforced Carbide Drill Reamer With Internal Coolant Holes x3D

## DRH3D2A

單位:mm(Unit:mm)

刀具料號 Model No.	刃徑 d Diameter	溝長 ℓ Grooving Length	全長 L Overall Length	柄徑 D Shank Diameter	在庫
DRH3D2A1090A	10.9	56	105	12	○
DRH3D2A1100A	11.0			12	○
DRH3D2A1110A	11.1	58	110	12	○
DRH3D2A1120A	11.2			12	○
DRH3D2A1130A	11.3			12	○
DRH3D2A1140A	11.4			12	○
DRH3D2A1150A	11.5			12	○
DRH3D2A1160A	11.6			60	110
DRH3D2A1170A	11.7	12	○		
DRH3D2A1180A	11.8	12	○		
DRH3D2A1190A	11.9	12	○		
DRH3D2A1200A	12.0	12	○		
DRH3D2A1210A	12.1	63	115		
DRH3D2A1220A	12.2			13	○
DRH3D2A1230A	12.3			13	○
DRH3D2A1240A	12.4			13	○
DRH3D2A1250A	12.5			13	○
DRH3D2A1260A	12.6			65	115
DRH3D2A1270A	12.7	13	○		
DRH3D2A1280A	12.8	13	○		
DRH3D2A1290A	12.9	13	○		
DRH3D2A1300A	13.0	13	○		
DRH3D2A1310A	13.1	68	125		
DRH3D2A1320A	13.2			14	○
DRH3D2A1330A	13.3			14	○
DRH3D2A1340A	13.4			14	○
DRH3D2A1350A	13.5			14	○
DRH3D2A1360A	13.6			70	125
DRH3D2A1370A	13.7	14	○		
DRH3D2A1380A	13.8	14	○		
DRH3D2A1390A	13.9	14	○		
DRH3D2A1400A	14.0	14	○		
DRH3D2A1410A	14.1	73	130		
DRH3D2A1420A	14.2			16	○
DRH3D2A1430A	14.3			16	○
DRH3D2A1440A	14.4			16	○
DRH3D2A1450A	14.5			16	○
DRH3D2A1460A	14.6			75	130
DRH3D2A1470A	14.7	16	○		
DRH3D2A1480A	14.8	16	○		
DRH3D2A1490A	14.9	16	○		
DRH3D2A1500A	15.0	16	○		
DRH3D2A1510A	15.1	78	135		
DRH3D2A1520A	15.2			16	○
DRH3D2A1530A	15.3			16	○
DRH3D2A1540A	15.4			16	○
DRH3D2A1550A	15.5			16	○
DRH3D2A1560A	15.6			80	135
DRH3D2A1570A	15.7	16	○		
DRH3D2A1580A	15.8	16	○		
DRH3D2A1590A	15.9	16	○		
DRH3D2A1600A	16.0	16	○		

○: 接單生產品 ●: 在庫品 ▲: 訂製品

鎢鋼鑽頭系列

# 加強型鎢鋼油孔鑽絞刀×5D

Reinforced Carbide Drill Reamer With Internal Coolant Holes x5D

低碳素鋼 Low Carbon Steels	中碳素鋼 Medium Carbon Steels	高碳素鋼 High Carbon Steels	合金鋼 Alloy Steels	工具鋼 Tool Steels	調質鋼 Hardened Steels	淬火鋼 Quenched and Tempered Steels			鑄鋼 Cast Steels	鑄鐵 Cast Iron		黃銅 Brass	青銅 Bronze	紅銅 Copper	鋁合金 Aluminum Rolled	不銹鋼 Stainless Steels			鈦合金 Titanium Alloys	鎳基合金 Nickel Alloys	碳纖維 Carbon Fiber	玻璃纖維 Glass Fiber
						HRC 30~40	HRC 40~50	HRC 50~60		SC	FC					FCD	300	400				
CO.25%以下	CO.25%~0.45%	CO.45%以上	SCM	SKD	HRC 20~30	HRC 30~40	HRC 40~50	HRC 50~60	SC	FC	FCD	BS	PB	CU	AL	300	400	600	TI			
◎	◎	◎	◎	○	◎	○	○		◎	◎	◎					○	○	○	○	○		

○適用 ◎專用

◆特性：增加副刃，有效延長刀具使用壽命，搭配中心出水的方式使排屑效率及冷卻效果極佳。

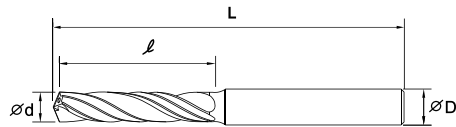

## DRH5D2B

單位:mm(Unit:mm)

刀具料號 Model No.	刃徑 d Diameter	溝長 l Grooving Length	全長 L Overall Length	柄徑 D Shank Diameter	在庫
DRH5D2B0030A	3.0	23	60	4	○
DRH5D2B0310A	3.1			6	○
DRH5D2B0320A	3.2			6	○
DRH5D2B0330A	3.3			6	●
DRH5D2B0335A	3.35	26	65	6	●
DRH5D2B0340A	3.4			6	●
DRH5D2B0350A	3.5			6	○
DRH5D2B0360A	3.6			6	○
DRH5D2B0370A	3.7			6	○
DRH5D2B0380A	3.8	30	70	6	○
DRH5D2B0390A	3.9			6	○
DRH5D2B0040A	4.0			6	○
DRH5D2B0410A	4.1			6	○
DRH5D2B0420A	4.2			6	●
DRH5D2B0425A	4.25			6	●
DRH5D2B0430A	4.3	33	75	6	●
DRH5D2B0440A	4.4			6	○
DRH5D2B0450A	4.5			6	○
DRH5D2B0460A	4.6			6	○
DRH5D2B0470A	4.7			6	○
DRH5D2B0480A	4.8	38	80	6	○
DRH5D2B0490A	4.9			6	○
DRH5D2B0050A	5.0			6	●
DRH5D2B0505A	5.05			6	●
DRH5D2B0510A	5.1			6	●
DRH5D2B0520A	5.2			6	○
DRH5D2B0530A	5.3	41	85	6	○
DRH5D2B0540A	5.4			6	○
DRH5D2B0550A	5.5			6	○
DRH5D2B0560A	5.6			6	○
DRH5D2B0570A	5.7			6	○
DRH5D2B0580A	5.8	44	90	6	○
DRH5D2B0590A	5.9			6	○
DRH5D2B0060A	6.0			6	○
DRH5D2B0610A	6.1	48		8	○

○: 接單生產 ●: 在庫品 ▲: 訂製品

# 加強型鎢鋼油孔鑽絞刀×5D

Reinforced Carbide Drill Reamer With Internal Coolant Holes x5D

## DRH5D2B

單位:mm(Unit:mm)

刀具料號 Model No.	刃徑 d Diameter	溝長 ℓ Grooving Length	全長 L Overall Length	柄徑 D Shank Diameter	在庫		
DRH5D2B0620A	6.2	48	90	8	○		
DRH5D2B0630A	6.3			8	○		
DRH5D2B0640A	6.4			8	○		
DRH5D2B0650A	6.5			8	○		
DRH5D2B0660A	6.6	51	100	8	○		
DRH5D2B0670A	6.7			8	○		
DRH5D2B0675A	6.75			8	●		
DRH5D2B0680A	6.8			8	●		
DRH5D2B0685A	6.85			8	●		
DRH5D2B0690A	6.9			8	○		
DRH5D2B0070A	7.0			8	○		
DRH5D2B0710A	7.1			54	100	8	○
DRH5D2B0720A	7.2	8	○				
DRH5D2B0730A	7.3	8	○				
DRH5D2B0740A	7.4	8	○				
DRH5D2B0750A	7.5	8	○				
DRH5D2B0760A	7.6	58	105	8	○		
DRH5D2B0770A	7.7			8	○		
DRH5D2B0780A	7.8			8	○		
DRH5D2B0790A	7.9			8	○		
DRH5D2B0080A	8.0			8	○		
DRH5D2B0810A	8.1	62	110	10	○		
DRH5D2B0820A	8.2			10	○		
DRH5D2B0830A	8.3			10	○		
DRH5D2B0840A	8.4			10	○		
DRH5D2B0850A	8.5			10	●		
DRH5D2B0855A	8.55			10	●		
DRH5D2B0860A	8.6			10	●		
DRH5D2B0870A	8.7	65	115	10	○		
DRH5D2B0880A	8.8			10	○		
DRH5D2B0890A	8.9			10	○		
DRH5D2B0090A	9.0			10	○		
DRH5D2B0910A	9.1			68	120	10	○
DRH5D2B0920A	9.2	10	○				
DRH5D2B0930A	9.3	10	○				
DRH5D2B0940A	9.4	10	○				
DRH5D2B0950A	9.5	10	○				
DRH5D2B0960A	9.6	72	125			10	○
DRH5D2B0970A	9.7					10	○
DRH5D2B0980A	9.8			10	○		
DRH5D2B0990A	9.9			10	○		
DRH5D2B0100A	10.0			10	○		
DRH5D2B1010A	10.1			75	125	12	○
DRH5D2B1020A	10.2					12	○
DRH5D2B1025A	10.25					12	●
DRH5D2B1030A	10.3	12	●				
DRH5D2B1035A	10.35	12	●				
DRH5D2B1040A	10.4	12	●				
DRH5D2B1050A	10.5	12	●				
DRH5D2B1060A	10.6	78	130	12	○		
DRH5D2B1070A	10.7			12	○		
DRH5D2B1080A	10.8			12	○		

○: 接單生產品    ●: 在庫品    ▲: 訂製品

鎢鋼鑽頭系列

# 加強型鎢鋼油孔鑽絞刀×5D

Reinforced Carbide Drill Reamer With Internal Coolant Holes x5D

## DRH5D2B

單位:mm(Unit:mm)

刀具料號 Model No.	刃徑 d Diameter	溝長 ℓ Grooving Length	全長 L Overall Length	柄徑 D Shank Diameter	在庫
DRH5D2B1090A	10.9	78	130	12	○
DRH5D2B1100A	11.0			12	○
DRH5D2B1110A	11.1	81		12	○
DRH5D2B1120A	11.2			12	○
DRH5D2B1130A	11.3			12	○
DRH5D2B1140A	11.4			12	○
DRH5D2B1150A	11.5	84	12	○	
DRH5D2B1160A	11.6		12	○	
DRH5D2B1170A	11.7		12	○	
DRH5D2B1180A	11.8		12	○	
DRH5D2B1190A	11.9		12	○	
DRH5D2B1200A	12.0		88	12	○
DRH5D2B1210A	12.1	13		○	
DRH5D2B1220A	12.2	13		○	
DRH5D2B1230A	12.3	13		○	
DRH5D2B1240A	12.4	13		○	
DRH5D2B1250A	12.5	13		○	
DRH5D2B1260A	12.6	91	145	13	○
DRH5D2B1270A	12.7			13	○
DRH5D2B1280A	12.8			13	○
DRH5D2B1290A	12.9			13	○
DRH5D2B1300A	13.0			13	○
DRH5D2B1310A	13.1			95	14
DRH5D2B1320A	13.2	14	○		
DRH5D2B1330A	13.3	14	○		
DRH5D2B1340A	13.4	14	○		
DRH5D2B1350A	13.5	14	○		
DRH5D2B1360A	13.6	98	14		○
DRH5D2B1370A	13.7		14	○	
DRH5D2B1380A	13.8		14	○	
DRH5D2B1390A	13.9		14	○	
DRH5D2B1400A	14.0		101	14	○
DRH5D2B1410A	14.1			16	○
DRH5D2B1420A	14.2	16		○	
DRH5D2B1430A	14.3	16		○	
DRH5D2B1440A	14.4	16		○	
DRH5D2B1450A	14.5	16		○	
DRH5D2B1460A	14.6	105	160	16	○
DRH5D2B1470A	14.7			16	○
DRH5D2B1480A	14.8			16	○
DRH5D2B1490A	14.9			16	○
DRH5D2B1500A	15.0			16	○
DRH5D2B1510A	15.1			108	16
DRH5D2B1520A	15.2	16	○		
DRH5D2B1530A	15.3	16	○		
DRH5D2B1540A	15.4	16	○		
DRH5D2B1550A	15.5	16	○		
DRH5D2B1560A	15.6	112	165		16
DRH5D2B1570A	15.7			16	○
DRH5D2B1580A	15.8			16	○
DRH5D2B1590A	15.9			16	○
DRH5D2B1600A	16.0			16	○

○: 接單生產品    ●: 在庫品    ▲: 訂製品

# 鎢鋼平底鑽頭×3D

## Carbide Flat Drills x3D

低碳素鋼 Low Carbon Steels	中碳素鋼 Medium Carbon Steels	高碳素鋼 High Carbon Steels	合金鋼 Alloy Steels	工具鋼 Tool Steels	調質鋼 Hardened Steels	淬火鋼 Quenched and Tempered Steels			鑄鋼 Cast Steels	鑄鐵 Cast Iron	黃銅 Brass	青銅 Bronze	紅銅 Copper	鋁合金 Aluminum Rolled	不銹鋼 Stainless Steels			鈦合金 Titanium Alloys	鎳基合金 Nickel Alloys	碳纖維 Carbon Fiber	玻璃纖維 Glass Fiber	
C0.25%以下	C0.25%~0.45%	C0.45%以上	SCM	SKD	HRC 20~30	HRC 30~40	HRC 40~50	HRC 50~60	SC	FC	FCD	BS	PB	CU	AL	300	400	600	TI			
◎	◎	◎	○	○	○	○			○	◎	○						○	○				

○ 適用 ◎ 專用

特性：

- ◆採用自行研發特殊刀刃設計，低阻力、加大溝深排屑順暢、不易纏屑，在高速加工的環境也能展現其穩定性。
- ◆針對曲面與斜面加工，亦有絕佳的精準度與效能，不易因加工時遇熱而產生硬化現象，刀具壽命佳。
- ◆端面刃口加工後平面度可達0.02mm內。

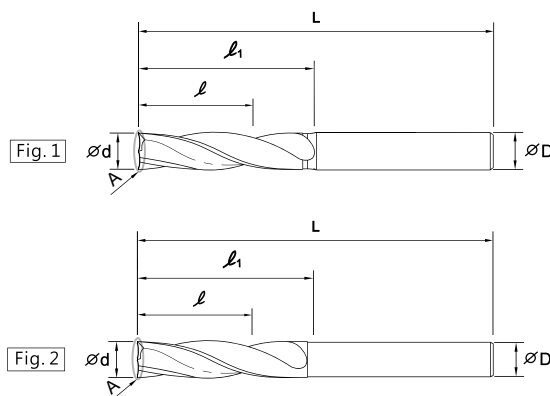
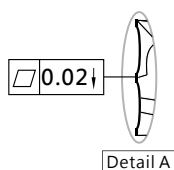

## FDS3D2A

單位:mm(Unit:mm)

刀具料號 Model No.	刃徑 d Diameter	刃長 l Flute Length	溝長 l1 Grooving Length	全長 L Overall Length	柄徑 D Shank Diameter	形狀 Figure	在庫		
FDS3D2A0030A	3.0	9.0	14	50	4	Fig. 1	●		
FDS3D2A0310A	3.1	9.3	15		4	Fig. 1	●		
FDS3D2A0320A	3.2	9.6			4	Fig. 1	●		
FDS3D2A0330A	3.3	9.9			4	Fig. 1	●		
FDS3D2A0335A	3.35	10.1			4	Fig. 1	●		
FDS3D2A0340A	3.4	10.2			4	Fig. 1	●		
FDS3D2A0350A	3.5	10.5			4	Fig. 1	●		
FDS3D2A0360A	3.6	10.8			4	Fig. 1	●		
FDS3D2A0370A	3.7	11.1			4	Fig. 1	●		
FDS3D2A0380A	3.8	11.4			18	4	Fig. 1	●	
FDS3D2A0390A	3.9	11.7		4		Fig. 1	●		
FDS3D2A040A	4.0	12.0	4	Fig. 1		●			
FDS3D2A0410A	4.1	12.3	20	4		Fig. 2	●		
FDS3D2A0420A	4.2	12.6		4		Fig. 2	●		
FDS3D2A0425A	4.25	12.8		4		Fig. 2	●		
FDS3D2A0430A	4.3	12.9		4		Fig. 2	●		
FDS3D2A0440A	4.4	13.2		22		4	Fig. 2	●	
FDS3D2A0450A	4.5	13.5				4	Fig. 2	●	
FDS3D2A0460A	4.6	13.8				6	Fig. 1	●	
FDS3D2A0470A	4.7	14.1			6	Fig. 1	●		
FDS3D2A0480A	4.8	14.4			23	6	Fig. 1	●	
FDS3D2A0490A	4.9	14.7				6	Fig. 1	●	
FDS3D2A0050A	5.0	15.0	25			6	Fig. 1	●	
FDS3D2A0505A	5.05	15.2				6	Fig. 1	●	
FDS3D2A0510A	5.1	15.3				25	6	Fig. 1	●
FDS3D2A0520A	5.2	15.6					6	Fig. 1	●
FDS3D2A0530A	5.3	15.9		6			Fig. 1	●	

○：接單生產品 ●：在庫品 ▲：訂製品

# 鎢鋼平底鑽頭×3D

## Carbide Flat Drills x3D

### FDS3D2A

單位:mm(Unit:mm)

刀具料號 Model No.	刃徑 d Diameter	刃長 ℓ Fluet Length	溝長 ℓ1 Grooving Length	全長 L Overall Length	柄徑 D Shank Diameter	形狀 Figure	在庫
FDS3D2A0540A	5.4	16.2	26	65	6	Fig. 1	●
FDS3D2A0550A	5.5	16.5			6	Fig. 1	●
FDS3D2A0560A	5.6	16.8			6	Fig. 1	●
FDS3D2A0570A	5.7	17.1	28		6	Fig. 1	●
FDS3D2A0580A	5.8	17.4			6	Fig. 1	●
FDS3D2A0590A	5.9	17.7			6	Fig. 1	●
FDS3D2A0600A	6.0	18.0	29	70	6	Fig. 1	●
FDS3D2A0610A	6.1	18.3			6	Fig. 2	●
FDS3D2A0620A	6.2	18.6			6	Fig. 2	●
FDS3D2A0630A	6.3	18.9	31		6	Fig. 2	●
FDS3D2A0640A	6.4	19.2			6	Fig. 2	●
FDS3D2A0650A	6.5	19.5			6	Fig. 2	●
FDS3D2A0660A	6.6	19.8	32	6	Fig. 2	●	
FDS3D2A0670A	6.7	20.1		6	Fig. 2	●	
FDS3D2A0675A	6.75	20.3		6	Fig. 2	●	
FDS3D2A0680A	6.8	20.4	34	80	8	Fig. 1	●
FDS3D2A0685A	6.85	20.6			8	Fig. 1	●
FDS3D2A0690A	6.9	20.7			8	Fig. 1	●
FDS3D2A0700A	7.0	21.0	34		8	Fig. 1	●
FDS3D2A0710A	7.1	21.3			8	Fig. 1	●
FDS3D2A0720A	7.2	21.6			8	Fig. 1	●
FDS3D2A0730A	7.3	21.9	35	85	8	Fig. 1	●
FDS3D2A0740A	7.4	22.2			8	Fig. 1	●
FDS3D2A0750A	7.5	22.5			8	Fig. 1	●
FDS3D2A0760A	7.6	22.8	37		8	Fig. 1	●
FDS3D2A0770A	7.7	23.1			8	Fig. 1	●
FDS3D2A0780A	7.8	23.4			8	Fig. 1	●
FDS3D2A0790A	7.9	23.7	38	90	8	Fig. 1	●
FDS3D2A0800A	8.0	24.0			8	Fig. 1	●
FDS3D2A0810A	8.1	24.3			8	Fig. 2	●
FDS3D2A0820A	8.2	24.6	40		8	Fig. 2	●
FDS3D2A0830A	8.3	24.9			8	Fig. 2	●
FDS3D2A0840A	8.4	25.2			8	Fig. 2	●
FDS3D2A0850A	8.5	25.5	41	85	8	Fig. 2	●
FDS3D2A0855A	8.55	25.7			8	Fig. 2	●
FDS3D2A0860A	8.6	25.8			42	10	Fig. 1
FDS3D2A0870A	8.7	26.1	10			Fig. 1	●
FDS3D2A0880A	8.8	26.4	10			Fig. 1	●
FDS3D2A0890A	8.9	26.7	44		10	Fig. 1	●
FDS3D2A0900A	9.0	27.0		10	Fig. 1	●	
FDS3D2A0910A	9.1	27.3		10	Fig. 1	●	
FDS3D2A0920A	9.2	27.6	44	90	10	Fig. 1	●
FDS3D2A0930A	9.3	27.9			10	Fig. 1	●
FDS3D2A0940A	9.4	28.2			10	Fig. 1	●
FDS3D2A0950A	9.5	28.5	46		10	Fig. 1	●
FDS3D2A0960A	9.6	28.8			10	Fig. 1	●
FDS3D2A0970A	9.7	29.1			46	10	Fig. 1
FDS3D2A0980A	9.8	29.4	10	Fig. 1		●	
FDS3D2A0990A	9.9	29.7	10	Fig. 1		●	
FDS3D2A0100A	10.0	30.0			10	Fig. 1	●

○: 接單生產 ●: 在庫品 ▲: 訂製品

# 鎢鋼平底鑽頭×3D

## Carbide Flat Drills x3D

### FDS3D2A

單位:mm(Unit:mm)

刀具料號 Model No.	刃徑 d Diameter	刃長 ℓ Fluet Length	溝長 ℓ1 Grooving Length	全長 L Overall Length	柄徑 D Shank Diameter	形狀 Figure	在庫
FDS3D2A1010A	10.1	30.3	47	90	10	Fig. 2	●
FDS3D2A1020A	10.2	30.6			●		
FDS3D2A1025A	10.25	30.8			●		
FDS3D2A1030A	10.3	30.9			●		
FDS3D2A1035A	10.35	31.1	49		10	Fig. 2	●
FDS3D2A1040A	10.4	31.2			10	Fig. 2	●
FDS3D2A1050A	10.5	31.5	49		12	Fig. 1	●
FDS3D2A1060A	10.6	31.8			12	Fig. 1	●
FDS3D2A1070A	10.7	32.1	50	95	12	Fig. 1	●
FDS3D2A1080A	10.8	32.4			12	Fig. 1	●
FDS3D2A1090A	10.9	32.7			12	Fig. 1	●
FDS3D2A1100A	11.0	33.0			12	Fig. 1	●
FDS3D2A1110A	11.1	33.3	51		12	Fig. 1	●
FDS3D2A1120A	11.2	33.6			12	Fig. 1	●
FDS3D2A1130A	11.3	33.9	53		12	Fig. 1	●
FDS3D2A1140A	11.4	34.2			12	Fig. 1	●
FDS3D2A1150A	11.5	34.5	53	100	12	Fig. 1	●
FDS3D2A1160A	11.6	34.8			12	Fig. 1	●
FDS3D2A1170A	11.7	35.1	55		12	Fig. 1	●
FDS3D2A1180A	11.8	35.4			12	Fig. 1	●
FDS3D2A1190A	11.9	35.7			12	Fig. 1	●
FDS3D2A1200A	12.0	36.0			12	Fig. 1	●
FDS3D2A1210A	12.1	36.3	56		12	Fig. 2	●
FDS3D2A1220A	12.2	36.6			12	Fig. 2	●
FDS3D2A1230A	12.3	36.9	58	12	Fig. 2	●	
FDS3D2A1240A	12.4	37.2		12	Fig. 2	●	
FDS3D2A1250A	12.5	37.5	58	105	12	Fig. 2	●
FDS3D2A1260A	12.6	37.8			12	Fig. 2	●
FDS3D2A1270A	12.7	38.1	59		12	Fig. 2	●
FDS3D2A1280A	12.8	38.4			12	Fig. 2	●
FDS3D2A1290A	12.9	38.7			12	Fig. 2	●
FDS3D2A1300A	13.0	39.0			60	12	Fig. 2
FDS3D2A1310A	13.1	39.3	14			Fig. 1	▲
FDS3D2A1320A	13.2	39.6	62		14	Fig. 1	▲
FDS3D2A1330A	13.3	39.9		14	Fig. 1	▲	
FDS3D2A1340A	13.4	40.2	62	14	Fig. 1	▲	
FDS3D2A1350A	13.5	40.5		14	Fig. 1	●	
FDS3D2A1360A	13.6	40.8	64	115	14	Fig. 1	▲
FDS3D2A1370A	13.7	41.1			14	Fig. 1	▲
FDS3D2A1380A	13.8	41.4			14	Fig. 1	▲
FDS3D2A1390A	13.9	41.7			14	Fig. 1	▲
FDS3D2A1400A	14.0	42.0	65		14	Fig. 1	●
FDS3D2A1410A	14.1	42.3			14	Fig. 2	▲
FDS3D2A1420A	14.2	42.6	67		14	Fig. 2	▲
FDS3D2A1430A	14.3	42.9			14	Fig. 2	▲
FDS3D2A1440A	14.4	43.2	67	14	Fig. 2	▲	
FDS3D2A1450A	14.5	43.5		14	Fig. 2	●	
FDS3D2A1460A	14.6	43.8	68	120	14	Fig. 2	▲
FDS3D2A1470A	14.7	44.1			14	Fig. 2	▲
FDS3D2A1480A	14.8	44.4			14	Fig. 2	▲

○: 接單生產品    ●: 在庫品    ▲: 訂製品



# 鎢鋼平底鑽頭×3D

## Carbide Flat Drills x3D

### FDS3D2A

單位:mm(Unit:mm)

刀具料號 Model No.	刃徑 d Diameter	刃長 ℓ Fluet Length	溝長 ℓ1 Grooving Length	全長 L Overall Length	柄徑 D Shank Diameter	形狀 Figure	在庫
FDS3D2A1490A	14.9	44.7	68	120	14	Fig. 2	▲
FDS3D2A1500A	15.0	45.0	70		14	Fig. 2	●
FDS3D2A1510A	15.1	45.3			16	Fig. 1	▲
FDS3D2A1520A	15.2	45.6			16	Fig. 1	▲
FDS3D2A1530A	15.3	45.9	71		16	Fig. 1	▲
FDS3D2A1540A	15.4	46.2			16	Fig. 1	▲
FDS3D2A1550A	15.5	46.5	71		125	16	Fig. 1
FDS3D2A1560A	15.6	46.8	73	16		Fig. 1	▲
FDS3D2A1570A	15.7	47.1		16		Fig. 1	▲
FDS3D2A1580A	15.8	47.4		16		Fig. 1	▲
FDS3D2A1590A	15.9	47.4	73	16		Fig. 1	▲
FDS3D2A1600A	16.0	48.0		16	Fig. 1	●	

○: 接單生產品    ●: 在庫品    ▲: 訂製品

# 加強型鎢鋼平底鑽絞刀×3D Reinforced Carbide Flat Drill Reamer x3D

低碳素鋼 Low Carbon Steels	中碳素鋼 Medium Carbon Steels	高碳素鋼 High Carbon Steels	合金鋼 Alloy Steels	工具鋼 Tool Steels	調質鋼 Hardened Steels	淬火鋼 Quenched and Tempered Steels			鑄鋼 Cast Steels	鑄鐵 Cast Iron	黃銅 Brass	青銅 Bronze	紅銅 Copper	鋁合金 Aluminum Rolled	不銹鋼 Stainless Steels			鈦合金 Titanium Alloys	鎳基合金 Nickel Alloys	碳纖維 Carbon Fiber	玻璃纖維 Glass Fiber	
C0.25%以下	C0.25%~0.45%	C0.45%以上	SCM	SKD	HRC 20~30	HRC 30~40	HRC 40~50	HRC 50~60	SC	FC	FCD	BS	PB	CU	AL	300	400	600	TI			
◎	◎	◎	○	○	○	○			○	◎	○						○	○				

○適用 ◎專用

特性：

- ◆增加副刃，有效延長刀具使用壽命。
- ◆端面刃口加工後平面度可達0.02mm內。

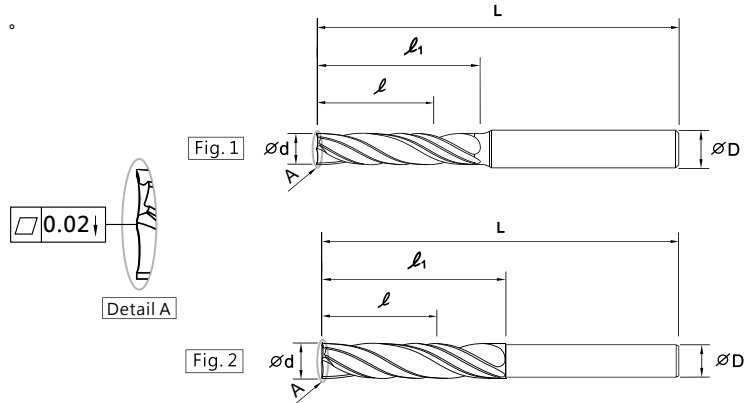

## FDRS3D2A

單位:mm(Unit:mm)

刀具料號 Model No.	刃徑 d Diameter	刃長 l Fluet Length	溝長 l1 Grooving Length	全長 L Overall Length	柄徑 D Shank Diameter	形狀 Figure	在庫	
FDRS3D2A0030A	3.0	9.0	14	50	4	Fig. 1	●	
FDRS3D2A0310A	3.1	9.3	15		4	Fig. 1	●	
FDRS3D2A0320A	3.2	9.6			4	Fig. 1	●	
FDRS3D2A0330A	3.3	9.9			4	Fig. 1	●	
FDRS3D2A0335A	3.35	10.1			4	Fig. 1	●	
FDRS3D2A0340A	3.4	10.2			4	Fig. 1	●	
FDRS3D2A0350A	3.5	10.5			4	Fig. 1	●	
FDRS3D2A0360A	3.6	10.8			4	Fig. 1	●	
FDRS3D2A0370A	3.7	11.1			18	4	Fig. 1	●
FDRS3D2A0380A	3.8	11.4				4	Fig. 1	●
FDRS3D2A0390A	3.9	11.7		4		Fig. 1	●	
FDRS3D2A040A	4.0	12.0	20	4		Fig. 1	●	
FDRS3D2A0410A	4.1	12.3		4		Fig. 2	●	
FDRS3D2A0420A	4.2	12.6		4		Fig. 2	●	
FDRS3D2A0425A	4.25	12.8		4		Fig. 2	●	
FDRS3D2A0430A	4.3	12.9		22		4	Fig. 2	●
FDRS3D2A0440A	4.4	13.2				4	Fig. 2	●
FDRS3D2A0450A	4.5	13.5				4	Fig. 2	●
FDRS3D2A0460A	4.6	13.8			6	Fig. 1	●	
FDRS3D2A0470A	4.7	14.1			23	6	Fig. 1	●
FDRS3D2A0480A	4.8	14.4				6	Fig. 1	●
FDRS3D2A0490A	4.9	14.7	6			Fig. 1	●	
FDRS3D2A0050A	5.0	15.0	25			6	Fig. 1	●
FDRS3D2A0505A	5.05	15.2				6	Fig. 1	●
FDRS3D2A0510A	5.1	15.3				25	6	Fig. 1
FDRS3D2A0520A	5.2	15.6		6			Fig. 1	●
FDRS3D2A0530A	5.3	15.9		6			Fig. 1	●

○：接單生產品 ●：在庫品 ▲：訂製品

# 加強型鎢鋼平底鑽絞刀×3D

## Reinforced Carbide Flat Drill Reamer x3D

### FDRS3D2A

單位:mm(Unit:mm)

刀具料號 Model No.	刃徑 d Diameter	刃長 ℓ Fluet Length	溝長 ℓ1 Grooving Length	全長 L Overall Length	柄徑 D Shank Diameter	形狀 Figure	在庫	
FDRS3D2A0540A	5.4	16.2		65	6	Fig. 1	●	
FDRS3D2A0550A	5.5	16.5	26		6	Fig. 1	●	
FDRS3D2A0560A	5.6	16.8			6	Fig. 1	●	
FDRS3D2A0570A	5.7	17.1	28		6	Fig. 1	●	
FDRS3D2A0580A	5.8	17.4			6	Fig. 1	●	
FDRS3D2A0590A	5.9	17.7			6	Fig. 1	●	
FDRS3D2A0600A	6.0	18.0		70	6	Fig. 1	●	
FDRS3D2A0610A	6.1	18.3	29		6	Fig. 2	●	
FDRS3D2A0620A	6.2	18.6			6	Fig. 2	●	
FDRS3D2A0630A	6.3	18.9			6	Fig. 2	●	
FDRS3D2A0640A	6.4	19.2	31		6	Fig. 2	●	
FDRS3D2A0650A	6.5	19.5			6	Fig. 2	●	
FDRS3D2A0660A	6.6	19.8			6	Fig. 2	●	
FDRS3D2A0670A	6.7	20.1	32		6	Fig. 2	●	
FDRS3D2A0675A	6.75	20.3			6	Fig. 2	●	
FDRS3D2A0680A	6.8	20.4			8	Fig. 1	●	
FDRS3D2A0685A	6.85	20.6			8	Fig. 1	●	
FDRS3D2A0690A	6.9	20.7			8	Fig. 1	●	
FDRS3D2A0700A	7.0	21.0	34	8	Fig. 1	●		
FDRS3D2A0710A	7.1	21.3	34	80	8	Fig. 1	●	
FDRS3D2A0720A	7.2	21.6			8	Fig. 1	●	
FDRS3D2A0730A	7.3	21.9			8	Fig. 1	●	
FDRS3D2A0740A	7.4	22.2			8	Fig. 1	●	
FDRS3D2A0750A	7.5	22.5	35		8	Fig. 1	●	
FDRS3D2A0760A	7.6	22.8			8	Fig. 1	●	
FDRS3D2A0770A	7.7	23.1			8	Fig. 1	●	
FDRS3D2A0780A	7.8	23.4	37		8	Fig. 1	●	
FDRS3D2A0790A	7.9	23.7			8	Fig. 1	●	
FDRS3D2A0800A	8.0	24.0			8	Fig. 1	●	
FDRS3D2A0810A	8.1	24.3			38	8	Fig. 2	●
FDRS3D2A0820A	8.2	24.6	8			Fig. 2	●	
FDRS3D2A0830A	8.3	24.9	8	Fig. 2		●		
FDRS3D2A0840A	8.4	25.2	8	Fig. 2		●		
FDRS3D2A0850A	8.5	25.5	40	8	Fig. 2	●		
FDRS3D2A0855A	8.55	25.7		8	Fig. 2	●		
FDRS3D2A0860A	8.6	25.8	40	85	10	Fig. 1	●	
FDRS3D2A0870A	8.7	26.1	41		10	Fig. 1	●	
FDRS3D2A0880A	8.8	26.4			10	Fig. 1	●	
FDRS3D2A0890A	8.9	26.7			10	Fig. 1	●	
FDRS3D2A0900A	9.0	27.0	42		10	Fig. 1	●	
FDRS3D2A0910A	9.1	27.3			10	Fig. 1	●	
FDRS3D2A0920A	9.2	27.6			10	Fig. 1	●	
FDRS3D2A0930A	9.3	27.9			10	Fig. 1	●	
FDRS3D2A0940A	9.4	28.2			44	10	Fig. 1	●
FDRS3D2A0950A	9.5	28.5	10			Fig. 1	●	
FDRS3D2A0960A	9.6	28.8	44		90	10	Fig. 1	●
FDRS3D2A0970A	9.7	29.1	46			10	Fig. 1	●
FDRS3D2A0980A	9.8	29.4		10		Fig. 1	●	
FDRS3D2A0990A	9.9	29.7		10		Fig. 1	●	
FDRS3D2A0100A	10.0	30.0		10		Fig. 1	●	

○: 接單生產品 ●: 在庫品 ▲: 訂製品

# 加強型鎢鋼平底鑽絞刀×3D

## Reinforced Carbide Flat Drill Reamer x3D

### FDRS3D2A

單位:mm(Unit:mm)

刀具料號 Model No.	刃徑 d Diameter	刃長 ℓ Fluet Length	溝長 ℓ1 Grooving Length	全長 L Overall Length	柄徑 D Shank Diameter	形狀 Figure	在庫
FDS3D2A1010A	10.1	30.3	47	90	10	Fig. 2	●
FDS3D2A1020A	10.2	30.6			●		
FDS3D2A1025A	10.25	30.8			●		
FDS3D2A1030A	10.3	30.9			●		
FDS3D2A1035A	10.35	31.1	49		10	Fig. 2	●
FDS3D2A1040A	10.4	31.2			10	Fig. 2	●
FDS3D2A1050A	10.5	31.5	49		12	Fig. 1	●
FDS3D2A1060A	10.6	31.8			12	Fig. 1	●
FDS3D2A1070A	10.7	32.1	50	95	12	Fig. 1	●
FDS3D2A1080A	10.8	32.4			12	Fig. 1	●
FDS3D2A1090A	10.9	32.7			12	Fig. 1	●
FDS3D2A1100A	11.0	33.0			12	Fig. 1	●
FDS3D2A1110A	11.1	33.3	51		12	Fig. 1	●
FDS3D2A1120A	11.2	33.6			12	Fig. 1	●
FDS3D2A1130A	11.3	33.9	53		12	Fig. 1	●
FDS3D2A1140A	11.4	34.2			12	Fig. 1	●
FDS3D2A1150A	11.5	34.5	53	100	12	Fig. 1	●
FDS3D2A1160A	11.6	34.8			12	Fig. 1	●
FDS3D2A1170A	11.7	35.1	55		12	Fig. 1	●
FDS3D2A1180A	11.8	35.4			12	Fig. 1	●
FDS3D2A1190A	11.9	35.7			12	Fig. 1	●
FDS3D2A1200A	12.0	36.0			12	Fig. 1	●
FDS3D2A1210A	12.1	36.3	56		12	Fig. 2	●
FDS3D2A1220A	12.2	36.6			12	Fig. 2	●
FDS3D2A1230A	12.3	36.9	58	12	Fig. 2	●	
FDS3D2A1240A	12.4	37.2		12	Fig. 2	●	
FDS3D2A1250A	12.5	37.5	58	105	12	Fig. 2	●
FDS3D2A1260A	12.6	37.8			12	Fig. 2	●
FDS3D2A1270A	12.7	38.1	59		12	Fig. 2	●
FDS3D2A1280A	12.8	38.4			12	Fig. 2	●
FDS3D2A1290A	12.9	38.7			12	Fig. 2	●
FDS3D2A1300A	13.0	39.0			60	12	Fig. 2
FDS3D2A1310A	13.1	39.3	14			Fig. 1	○
FDS3D2A1320A	13.2	39.6	62		14	Fig. 1	○
FDS3D2A1330A	13.3	39.9		14	Fig. 1	○	
FDS3D2A1340A	13.4	40.2	62	14	Fig. 1	○	
FDS3D2A1350A	13.5	40.5		14	Fig. 1	○	
FDS3D2A1360A	13.6	40.8	64	115	14	Fig. 1	○
FDS3D2A1370A	13.7	41.1			14	Fig. 1	○
FDS3D2A1380A	13.8	41.4			14	Fig. 1	○
FDS3D2A1390A	13.9	41.7			14	Fig. 1	○
FDS3D2A1400A	14.0	42.0	65		14	Fig. 1	○
FDS3D2A1410A	14.1	42.3			14	Fig. 2	○
FDS3D2A1420A	14.2	42.6	67		14	Fig. 2	○
FDS3D2A1430A	14.3	42.9			14	Fig. 2	○
FDS3D2A1440A	14.4	43.2	67	14	Fig. 2	○	
FDS3D2A1450A	14.5	43.5		14	Fig. 2	○	
FDS3D2A1460A	14.6	43.8	68	120	14	Fig. 2	○
FDS3D2A1470A	14.7	44.1			14	Fig. 2	○
FDS3D2A1480A	14.8	44.4			14	Fig. 2	○

○: 接單生產品 ●: 在庫品 ▲: 訂製品

鎢鋼鑽頭系列

# 加強型鎢鋼平底鑽絞刀×3D

## Reinforced Carbide Flat Drill Reamer x3D

### FDRS3D2A

單位:mm(Unit:mm)

刀具料號 Model No.	刃徑 d Diameter	刃長 ℓ Fluet Length	溝長 ℓ1 Grooving Length	全長 L Overall Length	柄徑 D Shank Diameter	形狀 Figure	在庫
FDRS3D2A1490A	14.9	44.7	68	120	14	Fig. 2	○
FDRS3D2A1500A	15.0	45.0	70		14	Fig. 2	○
FDRS3D2A1510A	15.1	45.3			16	Fig. 1	○
FDRS3D2A1520A	15.2	45.6			16	Fig. 1	○
FDRS3D2A1530A	15.3	45.9	71		16	Fig. 1	○
FDRS3D2A1540A	15.4	46.2			16	Fig. 1	○
FDRS3D2A1550A	15.5	46.5	71	125	16	Fig. 1	○
FDRS3D2A1560A	15.6	46.8	73		16	Fig. 1	○
FDRS3D2A1570A	15.7	47.1			16	Fig. 1	○
FDRS3D2A1580A	15.8	47.4			16	Fig. 1	○
FDRS3D2A1590A	15.9	47.4			16	Fig. 1	○
FDRS3D2A1600A	16.0	48.0		16	Fig. 1	○	

○: 接單生產品    ●: 在庫品    ▲: 訂製品

# 切削條件表

Cutting Condition Table

# 切削條件表

## Cutting Condition Table

**Table 01 鎢鋼高速鑽頭/加強型鎢鋼鑽絞刀切濕式加工條件表**

**Carbide High Speed Drill / Reinforced Carbide Drill Reamer Cutting Condition Table**

被削材	一般鋼		合金鋼		模具鋼		白鐵	
Work Material	SS400.S50C.FC250		SCM440		SKD61		SUS 400/600	
	~200HB		20~30HRC		30~40HRC			
外徑 Diameter (mm)	回轉速 Rotation (min <sup>-1</sup> )	進刀速度 Feed (mm/min)	回轉速 Rotation (min <sup>-1</sup> )	進刀速度 Feed (mm/min)	回轉速 Rotation (min <sup>-1</sup> )	進刀速度 Feed (mm/min)	回轉速 Rotation (min <sup>-1</sup> )	進刀速度 Feed (mm/min)
3	7650	380	6300	320	3330	170	4200	100
5	4590	590	3690	490	1980	230	2500	100
8	2880	590	2340	490	1260	230	2000	100
10	2300	590	1890	460	990	230	1600	100
12	1890	590	1530	430	860	210	1300	75
16	1440	500	1170	400	630	190	1000	75

切削條件注意事項：

- 1.請將鑽頭種類所標示的基準切削條件表內的數值作為新的加工並為大致標準。
- 2.因工件和加工設備的關係出現震動和異常聲響時，請根據情況變更加工條件。
- 3.如您使用的加工設備最高轉數到達基準切削條件時，請以其最高轉數進行加工。  
此時，請按相同比例降低進給速度。
- 4.建議依斷屑狀況退屑，避免造成鑽頭損壞。
- 5.加工深度5D以上建議先加導引孔。
- 6.於車床上加工刀具中心點與主軸中心需準確。

**Table 02 強力鎢鋼油孔鑽頭/加強型鎢鋼油孔鑽絞刀切濕式加工條件表**

**Carbide Drill With Internal Coolant Holes / Reinforced Carbide Drill Reamer With Internal Coolant Holes Cutting Condition Table**

被削材	一般鋼		合金鋼		模具鋼		白鐵	
Work Material	SS400.S50C.FC250		SCM440		SKD61		SUS 400/600	
	~200HB		20~30HRC		30~40HRC			
外徑 Diameter (mm)	回轉速 Rotation (min <sup>-1</sup> )	進刀速度 Feed (mm/min)	回轉速 Rotation (min <sup>-1</sup> )	進刀速度 Feed (mm/min)	回轉速 Rotation (min <sup>-1</sup> )	進刀速度 Feed (mm/min)	回轉速 Rotation (min <sup>-1</sup> )	進刀速度 Feed (mm/min)
3	7650	456	6300	384	3330	204	4200	120
5	4590	708	3690	588	1980	276	2500	120
8	2880	708	2340	588	1260	276	2000	120
10	2300	708	1890	552	990	276	1600	120
12	1890	708	1530	516	860	252	1300	90
16	1440	500	1170	480	630	228	1000	90

切削條件注意事項：

- 1.請將鑽頭種類所標示的基準切削條件表內的數值作為新的加工並為大致標準。
- 2.因工件和加工設備的關係出現震動和異常聲響時，請根據情況變更加工條件。
- 3.如您使用的加工設備最高轉數到達基準切削條件時，請以其最高轉數進行加工。  
此時，請按相同比例降低進給速度。
- 4.建議依斷屑狀況退屑，避免造成鑽頭損壞。
- 5.加工深度5D以上建議先加導引孔。
- 6.於車床上加工刀具中心點與主軸中心需準確。

# 切削條件表

## Cutting Condition Table

**Table 03 鎢鋼平底鑽頭/加強型鎢鋼平底鑽絞刀切濕式加工條件表**

**Carbide Flat Drills / Reinforced Carbide Flat Drill Reamer Cutting Condition Table**

被削材	一般鋼		合金鋼		淬硬鋼	
Work Material	SS400.S50C.FC		SCM440			
	~200HB		20~30HRC		30~40HRC	
外徑 Diameter (mm)	回轉速 Rotation (min <sup>-1</sup> )	進刀速度 Feed (mm/min)	回轉速 Rotation (min <sup>-1</sup> )	進刀速度 Feed (mm/min)	回轉速 Rotation (min <sup>-1</sup> )	進刀速度 Feed (mm/min)
3	7950	400	6900	280	3700	150
4	5950	420	5150	360	2800	170
5	4800	420	4150	360	2200	170
6	4000	420	3450	360	1800	170
8	3000	420	2600	360	1400	170
10	2400	420	2050	360	1100	170
12	2000	420	1700	360	950	170
16	1500	420	1300	360	700	170

切削條件注意事項：

- 1.請將鑽頭種類所標示的基準切削條件表內的數值作為新的加工並為大致標準。
- 2.因工件和加工設備的關係出現震動和異常聲響時，請根據情況變更加工條件。
- 3.如您使用的加工設備最高轉數到達基準切削條件時，請以其最高轉數進行加工。  
此時，請按相同比例降低進給速度。
- 4.建議依斷屑狀況退屑，避免造成鑽頭損壞。
- 5.刀具使用時，在允許狀態下，建議用定位鎖作加工。
- 6.於車床上加工刀具中心點與主軸中心需準確。