



吉輔企業有限公司
Gifu Enterprise Co., Ltd.

台灣總部 Taiwan

台灣台中市潭子區祥和路133巷33號
427 No.33, Ln. 133, Xianghe Rd., Tanzi Dist., Taichung City, Taiwan
Tel: +886-4-25389933、25379933、25334246、25334244
Fax: +886-4-25334224
E-mail: sales@atcgifu.com.tw

中國 上海營業部 China-Shanghai Office

上海市閔行區龍茗路2121弄15號1101室
Room 1101, No.15, Ln.2121, Longmin Rd., Minhang Dist., Shanghai, China
Tel: +86-21-34529067、34529068
Fax: +86-21-34529088
E-mail: gifush@163.com

www.atcgifu.com



2017.07



AUTOMATIC TOOL CHANGERS
綜合切削加工中心機刀庫

各
種





**ALWAYS BE GRATEFUL
TO THE ONES WHO GAVE**
飲水思源

CONTENTS

目錄

Company Profile 公司簡介	03
HORIZONTAL TYPE TOOL CHANGERS 臥式換刀刀庫	
Chain Type 鏈式刀庫	09
Umbrella Type 斗笠式刀庫	23
Disc Type 圓盤刀庫	24
VERTICAL TYPE TOOL CHANGERS 立式換刀刀庫	
Chain Type 鏈式刀庫	29
Umbrella Type 斗笠式刀庫	33
Disc Type 圓盤刀庫	37



COMPANY PROFILE

公司簡介

Gifu Enterprise Co., Ltd plays a leading role in AUTOMATIC TOOL CHANGER manufacturers in Taiwan. Due to the strength of R&D team, Gifu Enterprise Co., Ltd has excellent performance on both modularized products and high-end products. With innovative designs, precise performance in manufacturing, rich experiences on international marketing and completed after-sales services, Gifu Enterprise Co., Ltd is always your best choice to be a long-term manufacturing partner no matter in Taiwan or in the international market.

吉輔企業有限公司成立近40年並在台灣製造業扮演領導者的角色，是台灣第一家取得ISO 9001品質管理認證及實施生產管理系統GFPS (Gifu Production System 吉輔生產管理系統) 的專業刀庫大廠。我們重視創新並且積極研發刀庫，從模組化至高階客製化刀庫皆可滿足客戶需求並且有豐富的銷售實績，近年來吉輔企業陸續獲得「中小企業創新研究獎」、「經濟部傑出SBIR研發成果獎」、「台灣精品銀質獎」、「國家品牌玉山獎」等各類獎項的肯定，不論企業形象或產品品質，均為業界標竿，由於在設計及製造方面的傑出表現，吉輔企業有限公司是您作為長期合作夥伴的最佳選擇！



01

Gifu is established in 1979. We have the most professional research and development team with more than 35 experienced professionals. Aside from that, Gifu is the first professional tool changer manufacturer to earn the approval of Quality Assurance- BSI ISO 9001: 2015.

吉輔企業成立於1979年，我們擁有實力最雄厚的研發團隊，超過35位研發工程師。我們是台灣首家經認證之專業刀庫製造商，拿到品質管理認證：BSI ISO 9001:2015

02

Until now, Gifu has developed and produced over 400 models. Our products are sold to more than 300 well-known machine manufacturers in more than 30 countries.

至今我們已實際開發生產超過400種機型，此外我們的產品也銷售至超過30個國家300間以上知名的工具機廠商。

03

We have the most efficient after-sale service; besides, our sales representatives always respond to the customers through the Internet at the shortest time to support the clients worldwide.

最有效率的售後服務：我們不僅擁有22位以上售後服務工程師的售後服務團隊為世界各地的客戶服務，也同時搭配互聯網，使服務零距離、零時差。

HONESTY STABILITY AND INNOVATION

誠信 / 踏實 / 創新

CREATE INFINITE POSSIBILITY

創造無限可能

MANAGEMENT PHILOSOPHY AND VISION

經營理念與願景

Insisting on the operational principles of “honesty, stability and innovation”, we do the best to meet customers’ requirements and assist them in acquiring market opportunities.

Meanwhile, we put much effort and keep developing and offering our customers with high-end products to open up a blue sea market.

吉輔始終堅持誠信、踏實、創新的經營理念，並且竭盡所能協助客戶取得市場先機。

同時我們以近40年的基礎與創新研發為核心，持續研發高階及創新產品，並提升技術開拓全球新興國家與藍海新市場。

BUILDING THE PERFECT ACCURACY

建構精準完美

DEPENDENT PARTNER

信賴的合作夥伴

Due to our strict quality control, Gifu Enterprise wins the final trust of our clients.

We have the innovative ability allowing Gifu Enterprise to become the best partner for our clients.

Gifu is capable of providing the most accurate products and the best service to our clients anywhere at anytime.

因為嚴格的品質，

吉輔企業贏得客戶的最終信任。

因為創新的能力，

吉輔企業成為客戶最佳的夥伴。

吉輔企業任何時刻皆可提供最精準的服務、建構完美的產品。

HORIZONTAL TYPE ATC / CHAIN TYPE

臥式換刀刀庫 / 鏈式刀庫

Horizontal Rail-Type Tool Changer

滑軌臥式刀庫

PRODUCT FEATURES

- Cross-type tool arm with new patent.
- The tool changer allows to store and change dual type of tools.
- Commonly applied on horizontal boring/milling machining centers.

產品特點

- 新型專利之十字型換刀臂結構
- 可儲存、交換雙型式刀具
- 泛用於臥式搪銑床

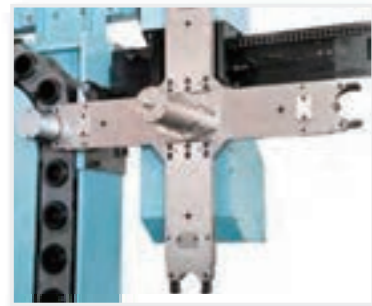
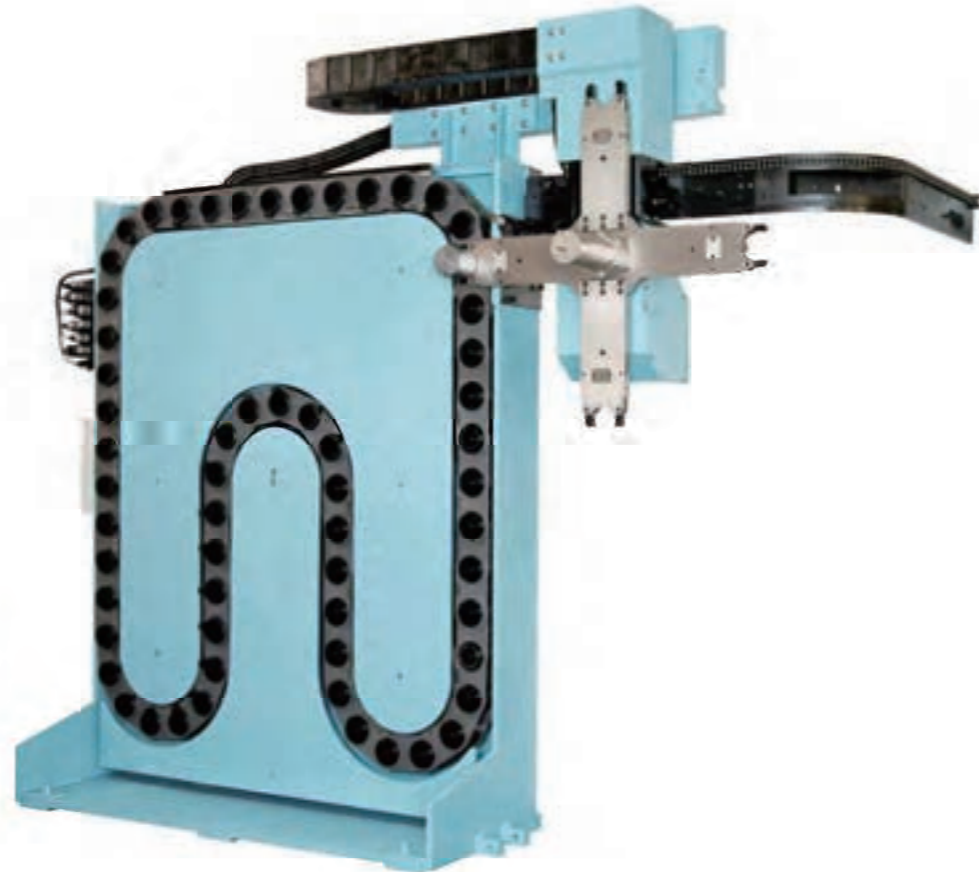

Tool Holder Type 刀具型式		BT / ISO / CAT / HSK	
Taper Type 刀把規格		50#(HSK-100)	
Max. Tool Weight 最大刀具重量		30	kg
Tool Diameter 刀具外徑	All pocket full 滿刀	Ø135	mm
	No Adjacent Tool 鄰空刀	Ø250	
Tool Capacity 刀具數量		40 / 60 / 90 / 120	T
Power Supply of Magazine 刀庫動力源		Servo / Hydraulic 伺服/油壓	
Tool Changing Mechanism 換刀機構		Hydraulic rack 油壓齒條	
Moving mechanism 移動機構		Electric / Servo / Hydraulic 電機/伺服/油壓	

Horizontal Rail-Type Tool Changer

滑軌臥式刀庫

PRODUCT FEATURES

- Light-weight aluminum structure of tool magazine.
- Integral forming aluminum tool pot.
- Commonly applied on horizontal boring / milling machining centers.

產品特點

- 採用輕量化鋁擠型結構
- 一體成型鋁壓鑄刀套
- 泛用於臥式搪銑床

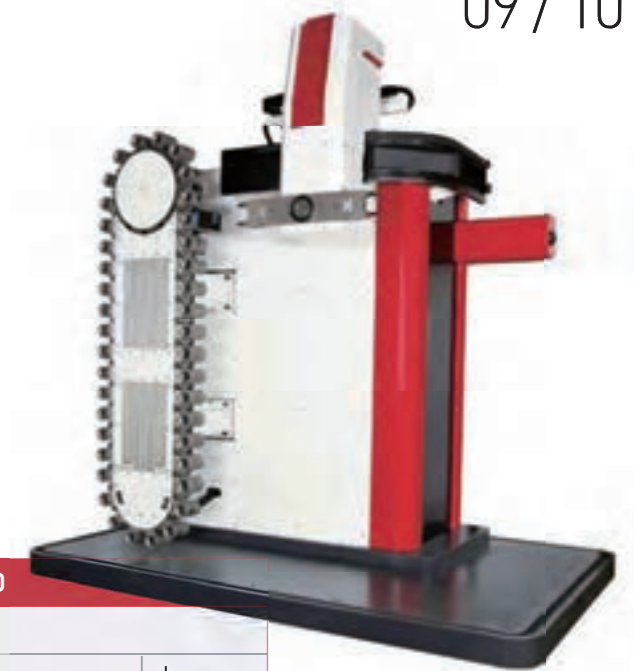

Tool Holder Type 刀具型式		BT / ISO / CAT / HSK-100	
Taper Type 刀把規格		50#	
Max. Tool Weight 最大刀具重量		25	kg
Tool Diameter 刀具外徑	All pocket full 滿刀	Ø125	mm
	No Adjacent Tool 鄰空刀	Ø250	
Tool Capacity 刀具數量		40 / 50 / 60	T
Power Supply of Magazine 刀庫動力源		Electric / Servo / Hydraulic 電機/伺服/油壓	
Tool Changing Mechanism 換刀機構		Hydraulic rack, Electric parallel movement 油壓齒條、電機平移	
Moving mechanism 移動機構		Electric / Servo / Hydraulic 電機/伺服/油壓	



台灣精品 2016
TAIWAN EXCELLENCE



Horizontal Rail-Type Tool Changer

滑軌臥式刀庫

PRODUCT FEATURES

- Commonly applied on horizontal boring / milling machining centers.

產品特點

- 泛用於臥式搪銑床

Tool Holder Type 刀具型式		BT / ISO / CAT / HSK		
Taper Type 刀把規格		40#(HSK-63)	50#(HSK-100)	60#(HSK-125)
Max. Tool Weight 最大刀具重量		8、12	35、50、60	50、70 kg
Tool Diameter 刀具外徑	All pocket full 滿刀	Ø80、Ø95	Ø125、Ø175	Ø170 mm
	No Adjacent Tool 鄰空刀	Ø150、Ø180	Ø250、Ø350	
Tool Capacity 刀具數量		20 / 24 / 30 / 32 / 40 / 60 / 90 T		
Power Supply of Magazine 刀庫動力源		Electric / Servo / Hydraulic 電機/伺服/油壓		
Tool Changing Mechanism 換刀機構		Hydraulic rack, electric horizontal movement 油壓齒條、電機平移		

HORIZONTAL TYPE ATC / CHAIN TYPE

臥式換刀刀庫 / 鏈式刀庫

Horizontal Rail-Type Tool Changer

滑軌臥式刀庫

PRODUCT FEATURES

- Special tool arm with dual-type opening claws.
- The tool changer allows to store and change dual type of tools.
- Expandable modularized magazine.
- Commonly applied on horizontal boring/milling machining center.

產品特點

- 雙型式開合夾爪刀臂
- 可儲存、交換雙型式刀具
- 擴充式模組化本體
- 泛用於臥式搪銑床



Dual Tool Holder Type 雙刀具型式		CAT-50 / HSK-63 / ISO-50 / CAPTO-8 / HSK-100 / BT-60			
Max. Tool Weight 最大刀具重量		18, 50	25, 50	50	kg
Tool Diameter 刀具外徑	All pocket full 滿刀	Ø125	Ø130	Ø125	mm
	No Adjacent Tool 鄰空刀	Ø250	Ø280	Ø250	
Tool Capacity 刀具數量		40 / 60 / 90 / 120			T
Power Supply of Magazine 刀庫動力源		Servo / Hydraulic 伺服/油壓			
Tool Changing Mechanism 換刀機構		Hydraulic rack, electric horizontal movement 油壓齒條、電機平移			
Arm Mechanism 刀臂機構		Two-sides independent hydraulic open claw 兩側獨立油壓開合式夾持			

Horizontal Rail-Type Tool Changer

平移臥式刀庫

PRODUCT FEATURES

- The tool changing mechanism is allowed to move to the tool changing position at the spindle side.
- Commonly applied on horizontal boring machines.

產品特點

- 換刀機構可長距離水平移動至主軸換刀位置
- 泛用於臥式加工中心機、臥式搪銑床



Tool Holder Type 刀具型式		BT / ISO / CAT / HSK		
Taper Type 刀把規格		40#(HSK-63)		50#(HSK-100)
Max. Tool Weight 最大刀具重量		8, 12	35, 50, 60	
Tool Diameter 刀具外徑	All pocket full 滿刀	Ø80, Ø95	Ø125, Ø175	
	No Adjacent Tool 鄰空刀	Ø150, Ø180	Ø250, Ø350	
Tool Capacity 刀具數量		40 / 50 / 60 / 120		T
Power Supply of Magazine 刀庫動力源		Electric / Hydraulic / Servo 電機/油壓/伺服		
Tool Changing Mechanism 換刀機構		Hydraulic rack / Electric / Servo 油壓齒條/電機/伺服		
Horizontal moving Mechanism 平移機構		Hydraulic sliding / Servo 油壓式平移/伺服電機		

HORIZONTAL TYPE ATC / CHAIN TYPE

臥式換刀刀庫 / 鏈式刀庫

Horizontal Chain-Type Tool Changer 臥式快速換刀刀庫

PRODUCT FEATURES

- 90-degree swinging mechanism with sub-tool pot.
- Equipped with high-speed tool changing mechanism.
- Commonly applied on horizontal machining centers.

產品特點

- 副刀套搖擺90度機構
- 搭配快速型臥式換刀機構
- 泛用於臥式加工中心機

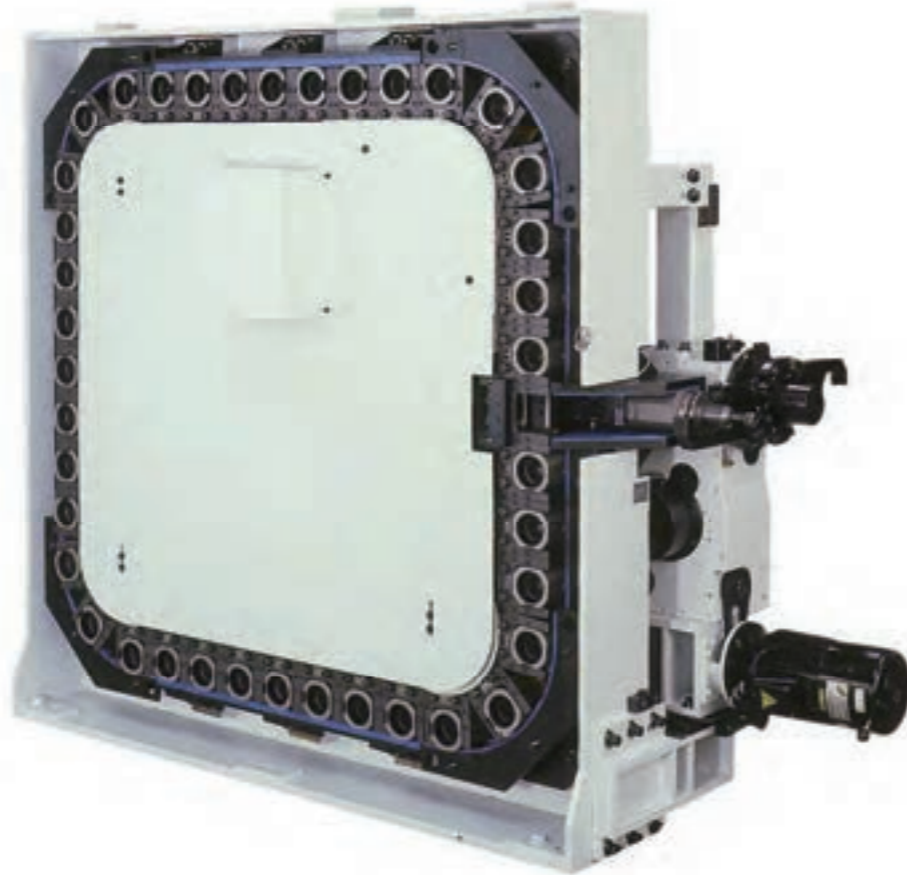

Tool Holder Type 刀具型式		BT / ISO / CAT / HSK		
Taper Type 刀把規格		40#(HSK-63)	50#(HSK-100)	
Max. Tool Weight 最大刀具重量		8	25	kg
Tool Diameter 刀具外徑	All pocket full 滿刀	Ø95	Ø125	
	No Adjacent Tool 鄰空刀	Ø190	Ø250	
Tool Capacity 刀具數量		40 / 60 / 90 / 120		
Power Supply of Magazine 刀庫動力源		Electric / Hydraulic / Servo 電機/油壓/伺服		
Tool Changing Mechanism 換刀機構		Cam-type changing mechanism 凸輪式換刀機構		

Intelligent Chain-Type ATC with Door Open Simultaneously with Tool Arm 智能化同動開門快速換刀刀庫

PRODUCT FEATURES

- Equipped with intelligent tool damage detection system, intelligent tool changing system with varied speed and lifetime predictive maintenance system.
- Cam-type tool changing mechanism with door open simultaneously.
- tenon tool pot.
- 90-degree swinging mechanism with sub-tool pot.
- Commonly applied on horizontal machining centers.

產品特點

- 搭載智能化變頻式換刀系統、
- 壽命偵測系統、刀具斷刀檢測系統
- 正位複合凸輪式同動開門換刀機構
- 卡榫式刀套
- 副刀套搖擺90度機構
- 泛用於臥式加工中心機



Tool Holder Type 刀具型式		BT / ISO / CAT / HSK-100		
Taper Type 刀把規格		50#		
Max. Tool Weight 最大刀具重量		25		kg
Tool Diameter 刀具外徑	All pocket full 滿刀	Ø125		
	No Adjacent Tool 鄰空刀	Ø250		
Tool Capacity 刀具數量		40/60		T
Power Supply of Magazine 刀庫動力源		Electric / Servo 電機/伺服		
Tool Changing Mechanism 換刀機構		Servo 伺服		

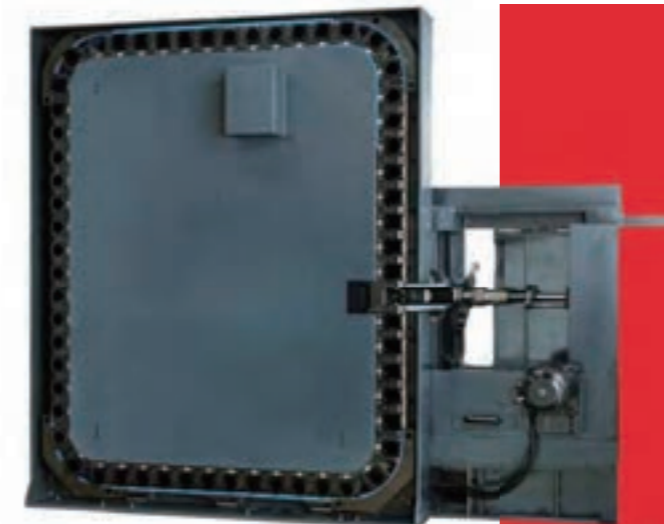

High-Speed Tool Changer with Spindle And Door Open Simultaneously 同動開門快速換刀刀庫

PRODUCT FEATURES

- 90-degree swinging mechanism with sub-tool pot.
- Cam-type tool changing mechanism with door open simultaneously.
- Commonly applied on horizontal machining centers.

產品特點

- 副刀套搖擺90度機構
- 凸輪式同動開門換刀機構
- 泛用於臥式加工機

Tool Holder Type 刀具型式		BT / ISO / CAT / HSK		
Taper Type 刀把規格		40#(HSK-63)	50#(HSK-100)	
Max. Tool Weight 最大刀具重量		8	25	kg
Tool Diameter 刀具外徑	All pocket full 滿刀	Ø95	Ø125	
	No Adjacent Tool 鄰空刀	Ø150	Ø250	
Tool Capacity 刀具數量		40 / 50 / 60 / 120		
Power Supply of Magazine 刀庫動力源		Hydraulic / Servo 油壓/伺服		
Tool Changing Mechanism 換刀機構		Reverse complex cam-type changing mechanism 反邊複合式凸輪換刀機構		

Vertical / Horizontal Tool Changer with Swinging Tool Changing Mechanism 搖擺式立臥型刀庫

PRODUCT FEATURES

- Equipped with 90-degree swinging tool changing mechanism.
- The tools can be changed vertically and horizontally.
- Commonly applied on double-column machining centers.

產品特點

- 搖擺機構可進行0~90度搖擺
- 換刀機構可進行立式或臥式雙型式換刀
- 泛用於龍門加工中心機



Tool Holder Type 刀具型式		BT / ISO / CAT / HSK		
Taper Type 刀把規格		40#(HSK-63)	50#(HSK-100)	
Max. Tool Weight 最大刀具重量		8, 12	35, 50, 60	kg
Tool Diameter 刀具外徑	All pocket full 滿刀	Ø80、Ø95	Ø125、Ø175	
	No Adjacent Tool 鄰空刀	Ø150、Ø180	Ø250、Ø350	
Tool Capacity 刀具數量		40 / 60 / 90 / 120		
Power Supply of Magazine 刀庫動力源		Electric / Servo / Hydraulic 電機/伺服/油壓		
Tool Changing Mechanism 換刀機構		Hidden hydraulic rack 內藏油壓齒條		

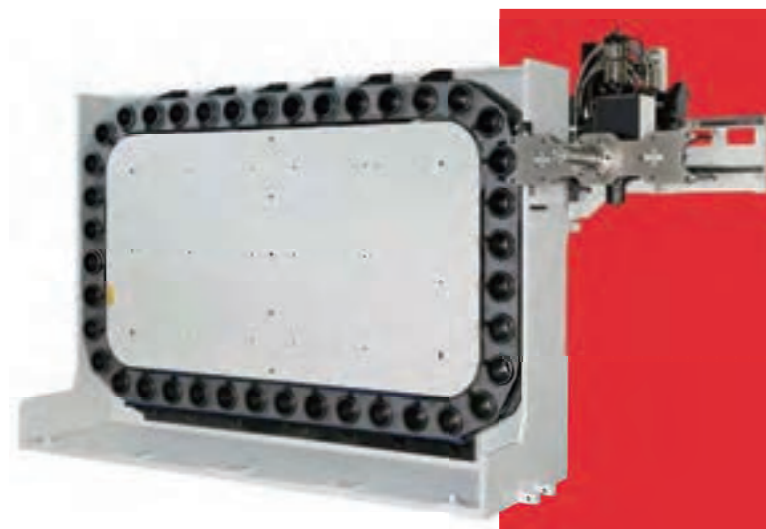

Horizontal Tool Changer with Swinging Tool Changing Mechanism 搖擺型臥式刀庫

PRODUCT FEATURES

- Equipped with 90-degree swinging tool changing mechanism.
- Commonly applied on horizontal machining centers.

產品特點

- 搖擺機構可進行0~90度搖擺
- 泛用於臥式加工中心機

Tool Holder Type 刀具型式		BT / ISO / CAT / HSK			
Taper Type 刀把規格		40#(HSK-63)	50#(HSK-100)	60#(HSK-125)	
Max. Tool Weight 最大刀具重量		8, 12	35, 50, 60	50, 70	kg
Tool Diameter 刀具外徑	All pocket full 滿刀	Ø80、Ø95	Ø125、Ø175	Ø170	mm
	No Adjacent Tool 鄰空刀	Ø150、Ø180	Ø250、Ø350	Ø350	
Tool Capacity 刀具數量		40 / 60 / 90 / 120			
Power Supply of Magazine 刀庫動力源		Electric / Servo / Hydraulic 電機/伺服/油壓			
Tool Changing Mechanism 換刀機構		Hydraulic rack 油壓齒條			

HORIZONTAL TYPE ATC / CHAIN TYPE 臥式換刀刀庫 / 鏈式刀庫

Horizontal Chain-Type Tool Changer 臥式快速換刀刀庫

PRODUCT FEATURES

- Cam-type tool clamping mechanism with swinging sub-tool pot and sub claw.
- Equipped with high-speed tool changing mechanism.
- Expandable and modularized tool storage.
- Commonly applied on horizontal machining centers.

產品特點

- 複合式夾出機構(副刀臂夾出、副刀套搖擺90度)
- 搭配快速型臥式換刀機構
- 採模組化擴充式儲刀倉
- 泛用於臥式加工中心機

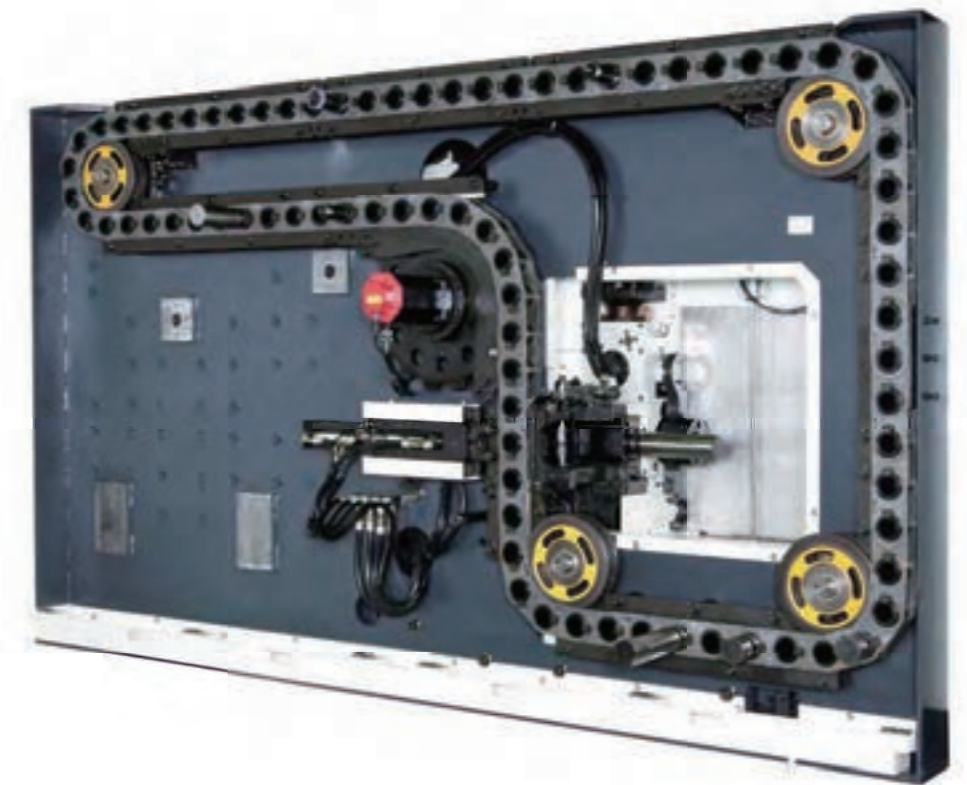

Tool Holder Type 刀具型式		BT / ISO / CAT / HSK			
Taper Type 刀把規格		40#(HSK-63)	50#(HSK-100)	60#(HSK-125)	
Max. Tool Weight 最大刀具重量		8	20, 25, 35	50	kg
Tool Diameter 刀具外徑	All pocket full 滿刀	Ø95	Ø125	Ø170	
	No Adjacent Tool 鄰空刀	Ø185	Ø245	Ø350	
Tool Capacity 刀具數量		40 / 60 / 80 / 90 / 120 / 220			
Power Supply of Magazine 刀庫動力源		Hydraulic / Servo 油壓/伺服			
Tool Changing Mechanism 換刀機構		Cam-type tool changing mechanism 凸輪式換刀機構			

HORIZONTAL TYPE ATC / CHAIN TYPE

臥式換刀刀庫 / 鏈式刀庫

Horizontal & Expandable Tool Changer

臥式擴充型換刀刀庫

PRODUCT FEATURES

- Expandable structure of magazine.
- Equipped with 90-degree swinging tool changing mechanism.
- Commonly applied on horizontal machining centers.

產品特點

- 擴充式刀倉結構
- 搭配搖擺90度換刀機構
- 泛用於臥式加工中心機

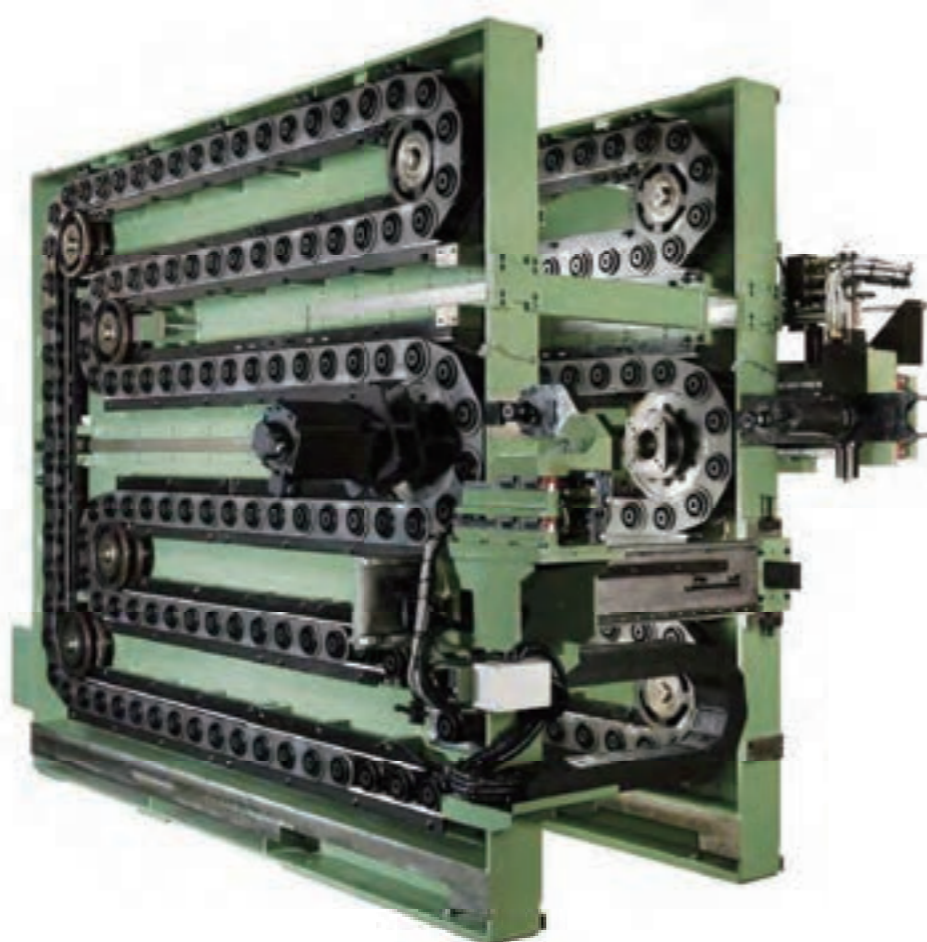

Tool Holder Type 刀具型式		BT / ISO / CAT / HSK		
Taper Type 刀把規格		40#(HSK-63)	50#(HSK-100)	
Max. Tool Weight 最大刀具重量		8、12	35、50、60	kg
Tool Diameter 刀具外徑	All pocket full 滿刀	Ø85、Ø95	Ø125、Ø175	mm
	No Adjacent Tool 鄰空刀	Ø150、Ø180	Ø250、Ø350	
Tool Capacity 刀具數量		40 / 60 / 80 / 90 / 120 / 240 / 360		T
Power Supply of Magazine 刀庫動力源		Servo / Hydraulic 伺服 / 油壓		
Tool Changing Mechanism 換刀機構		Hydraulic rack 油壓齒條		

Expandable Matrix Tool Changer

矩陣型擴充式刀庫

PRODUCT FEATURES

- Tool-catching mechanism with sub tool pot.
- Equipped with sliding tool changing mechanism.
- Modularized matrix magazine with expandable structure.
- Commonly applied on horizontal machining centers.

產品特點

- 副刀套取刀機構
- 搭載滑軌式換刀機構
- 模組化矩陣型擴充式刀倉結構
- 泛用於臥式加工中心機



Tool Holder Type 刀具型式		BT/ISO/CAT/HSK-40A		
Taper Type 刀把規格		30#		
Max. Tool Weight 最大刀具重量		1.2		kg
Tool Diameter 刀具外徑	All pocket full 滿刀	Ø40		mm
	No Adjacent Tool 鄰空刀			
Tool Capacity 刀具數量		120		T
Power Supply of Magazine 刀庫動力源		Hydraulic 油壓		
Tool Changing Mechanism 換刀機構		Double servo electric, ball screw 雙伺服電機、滾珠螺桿		
Horizontal moving Mechanism 平移機構		Quick-disassembling device 快速拆卸裝置		

HORIZONTAL TYPE ATC / CHAIN TYPE

臥式換刀刀庫 / 鏈式刀庫

Horizontal & Expandable Tool Changer 臥式擴充型換刀刀庫

PRODUCT FEATURES

- Long-Distance shifting-out mechanism of sub tool pot.
- Expandable structure of tool magazine.
- Commonly applied on horizontal machining centers.

產品特點

- 遠距離副刀套移出機構
- 擴充式刀倉結構
- 泛用於臥式加工中心機

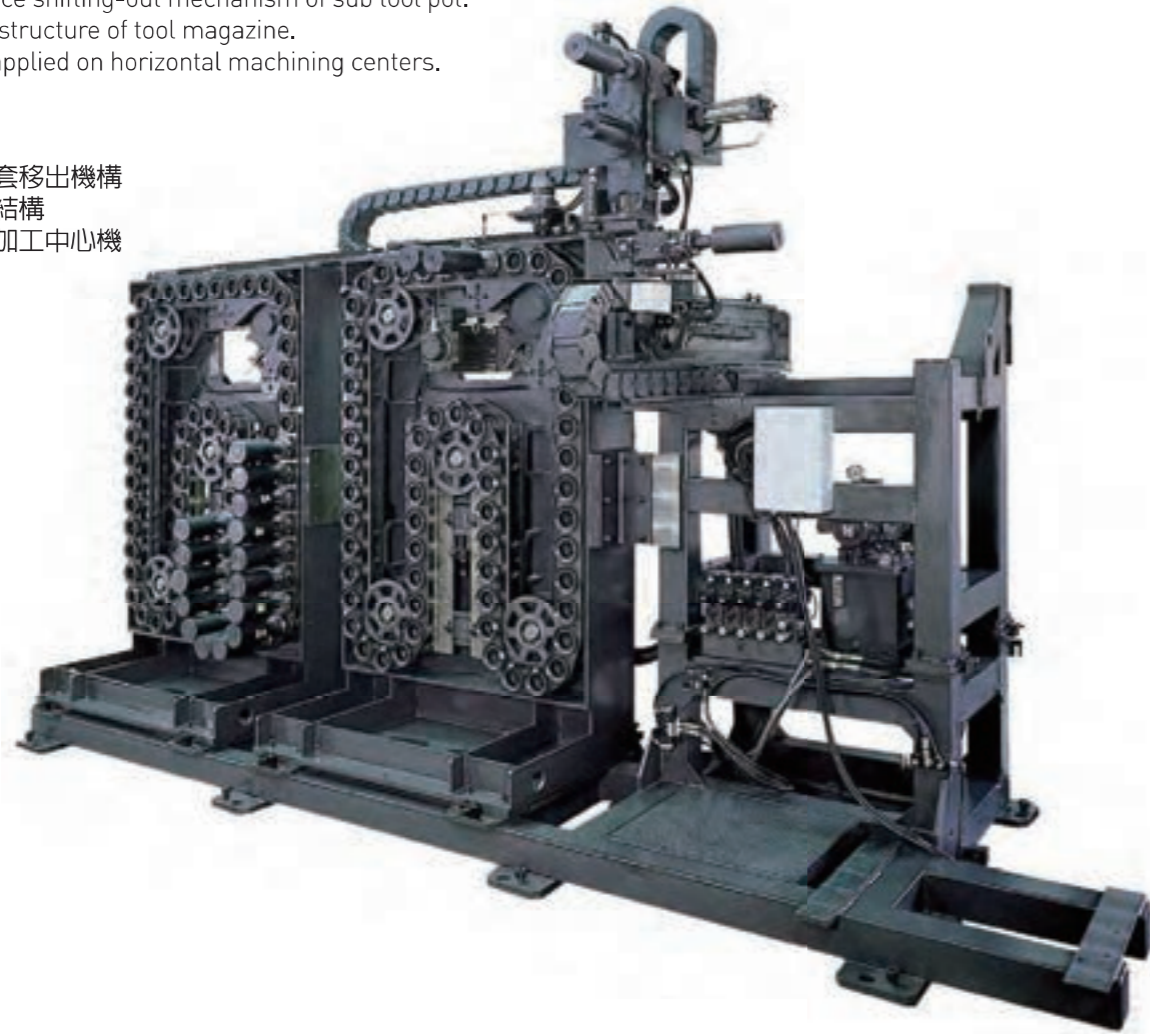

Tool Holder Type 刀具型式		BT / ISO / CAT / HSK	
Taper Type 刀把規格		40#(HSK-63)	50#(HSK-100)
Max. Tool Weight 最大刀具重量		8	35
Tool Diameter 刀具外徑	All pocket full 滿刀	Ø95	Ø125
	No Adjacent Tool 鄰空刀	Ø150	Ø250
Tool Capacity 刀具數量		40 / 50 / 60 / 120 / 240	T
Power Supply of Magazine 刀庫動力源		Servo 伺服	
Tool Changing Mechanism 換刀機構		Hydraulic rack 油壓齒條	
Movement Mechanism 平移機構		Hydraulic rack 油壓齒條	

Double-Deck ATC with Long Distance & Move Parallel Tool Changing for Turning / Milling Centers 車銑複合遠距離平移式換刀臥式雙刀庫

PRODUCT FEATURES

- 90 degree tool arm.
- Expandable tool magazine.
- Commonly applied on multi-tasking machining centers.

產品特點

- 90度換刀臂設計
- 車銑複合專用機
- 擴充式刀倉結構
- 泛用於車銑複合加工中心機

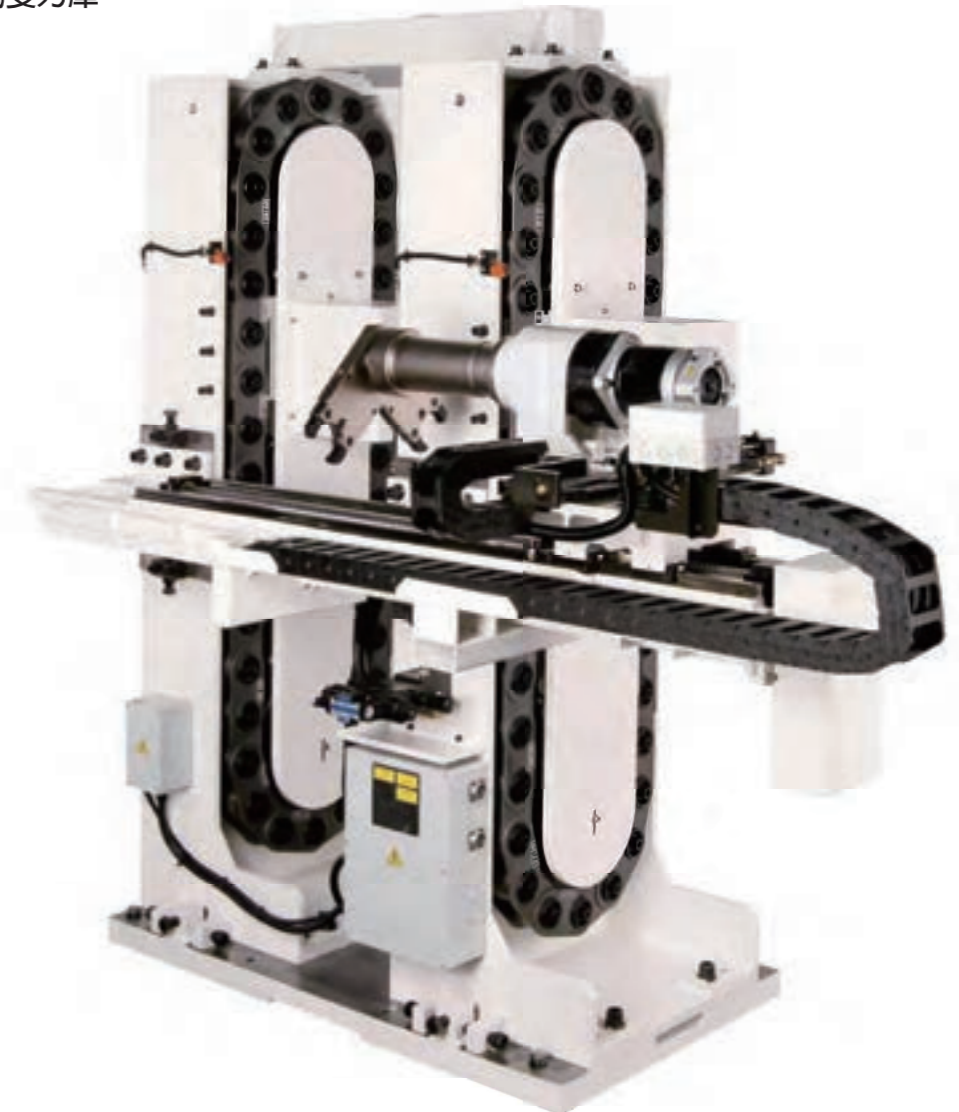

Tool Holder Type 刀具型式		BT/ISO/CAT/HSK-63	
Taper Type 刀把規格		40#	
Max. Tool Weight 最大刀具重量		8	kg
Tool Diameter 刀具外徑	All pocket full 滿刀	Ø90	mm
	No Adjacent Tool 鄰空刀	Ø140	
Tool Capacity 刀具數量		36 / 72	T
Power Supply of Magazine 刀庫動力源		Servo / Electric 伺服/電機	
Tool Changing Mechanism 換刀機構		Servo 伺服	
Horizontal Moving Mechanism 平移機構		Hydraulic parallel movement 油壓平移	

HORIZONTAL TYPE ATC / CHAIN TYPE

臥式換刀刀庫 / 鏈式刀庫

Specialized Tool Changer for Industrialized Flexible Production Line

智慧化彈性製造專用刀庫

PRODUCT FEATURES

- Adopts CCD tool detective device.
- The tool changer works with manipulator for tool catching on automated flexible production system.
- It can be applied on automated production.

產品特點

- 搭載 CCD 自動刀具檢測裝置
- 自動化彈性製造系統之機械手取刀專用機
- 配置於自動化產線

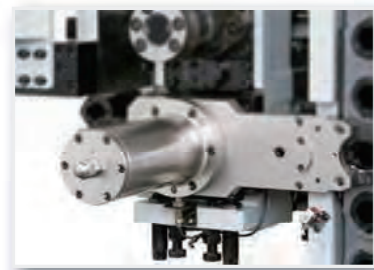
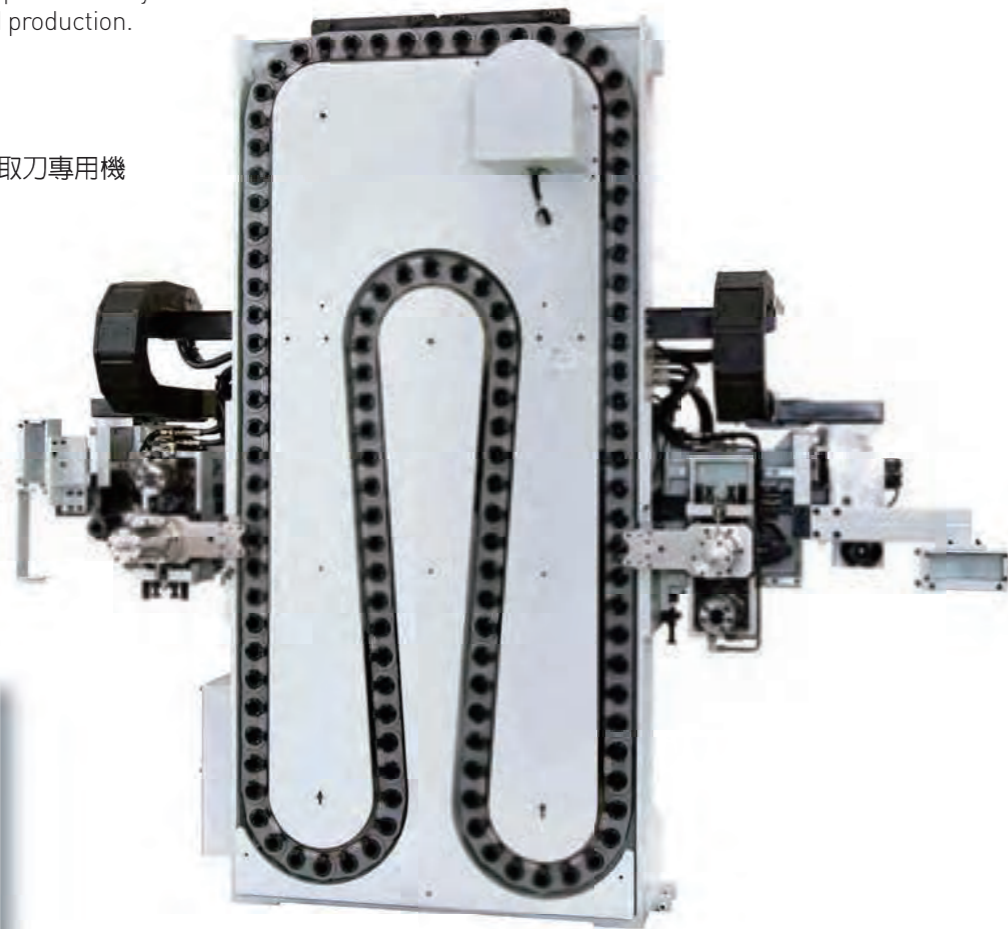

Tool Holder Type 刀具型式		BT / ISO / CAT / HSK-40	
Taper Type 刀把規格		30#	
Max. Tool Weight 最大刀具重量		3	kg
Tool Diameter 刀具外徑	All pocket full 滿刀	Ø75	mm
	No Adjacent Tool 鄰空刀	Ø75	
Tool Capacity 刀具數量		60 / 90 / 120	T
Power Supply of Magazine 刀庫動力源		Servo 伺服	
Tool Changing Mechanism 換刀機構		Hydraulic 油壓	

Horizontal Chain-Type Tool Changer

鏈式型臥式快速換刀刀庫

PRODUCT FEATURES

- 90-degree swinging mechanism with sub-tool pot.
- Commonly applied on horizontal machining centers.

產品特點

- 副刀套移出搖擺90度機構
- 泛用於臥式加工中心機

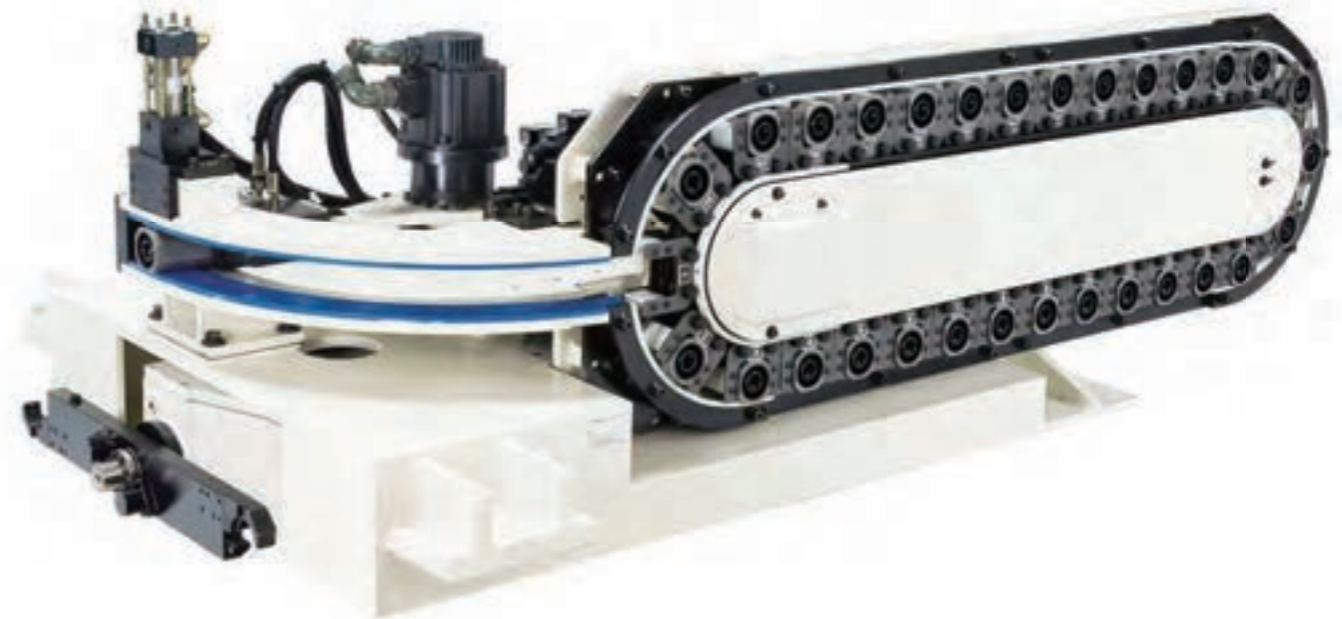

Tool Holder Type 刀具型式		BT / ISO / CAT / HSK		
Taper Type 刀把規格		40#(HSK-63)	50#(HSK-100)	
Max. Tool Weight 最大刀具重量		8	25	kg
Tool Diameter 刀具外徑	All pocket full 滿刀	Ø95	Ø125	mm
	No Adjacent Tool 鄰空刀	Ø150	Ø250	
Tool Capacity 刀具數量		40 / 50 / 60 / 80 / 90		
Power Supply of Magazine 刀庫動力源		Electric 電機		
Tool Changing Mechanism 換刀機構		Cam-type tool changing mechanism 凸輪式換刀機構		

HORIZONTAL TYPE ATC / UMBRELLA TYPE

臥式換刀刀庫 / 斗笠式刀庫

Horizontal Carousel Tool Changer

圓盤斗笠臥式刀庫

PRODUCT FEATURES

- Light-weight tool disc.
- Commonly applied on horizontal machining centers.

產品特點

- 輕量化刀盤結構
- 泛用於臥式加工中心機



Intelligent Radial Pattern Tool Changer (Disc Type)

智能化放射型圓盤式刀庫

PRODUCT FEATURES

- Integral forming aluminum tool pot.
- Equipped with intelligent detecting system for drill damage detection and examination system and lifetime predictive maintenance system.
- Downsized design is helpful for space saving.
- Commonly applied on horizontal machining centers.

產品特點

- 一體成型鋁壓鑄刀套
- 搭載智能化刀具斷刀檢測系統、壽命偵測系統
- 縮小刀庫佔地面積
- 泛用於臥式加工中心機



台灣精品 2017
TAIWAN EXCELLENCE

HORIZONTAL TYPE ATC / DISC TYPE

臥式換刀刀庫 / 圓盤刀庫

Tool Holder Type 刀具型式		HSK	
Taper Type 刀把規格		30# (HSK-40E)	40#(HSK-63A)
Max. Tool Weight 最大刀具重量		8	12
Tool Diameter 刀具外徑	All pocket full 滿刀	Ø65	Ø100
	No Adjacent Tool 鄰空刀	Ø100	Ø125
Tool Capacity 刀具數量		12 / 16 / 24	T
Power Supply of Magazine 刀庫動力源		Servo 伺服	

Tool Holder Type 刀具型式		BT / ISO / CAT / HSK	
Taper Type 刀把規格		40#(HSK-63)	50#(HSK-100)
Max. Tool Weight 最大刀具重量		8	25
Tool Diameter 刀具外徑	All pocket full 滿刀	Ø80	Ø125
	No Adjacent Tool 鄰空刀	Ø130	Ø250
Tool Capacity 刀具數量		40 / 60	T
Power Supply of Magazine 刀庫動力源		Electric / Servo 電機/伺服	
Tool Changing Mechanism 換刀機構		Electric / Servo 電機/伺服	

HORIZONTAL TYPE ATC / DISC TYPE

臥式換刀刀庫 / 圓盤刀庫

Horizontal Radical-Type Tool Changer

圓盤臥式放射狀快速換刀刀庫

PRODUCT FEATURES

- 90 degree swinging tool pot.
- Commonly applied on horizontal machining centers.

產品特點

- 移出式刀套搖擺90度機構
- 泛用於臥式加工中心機

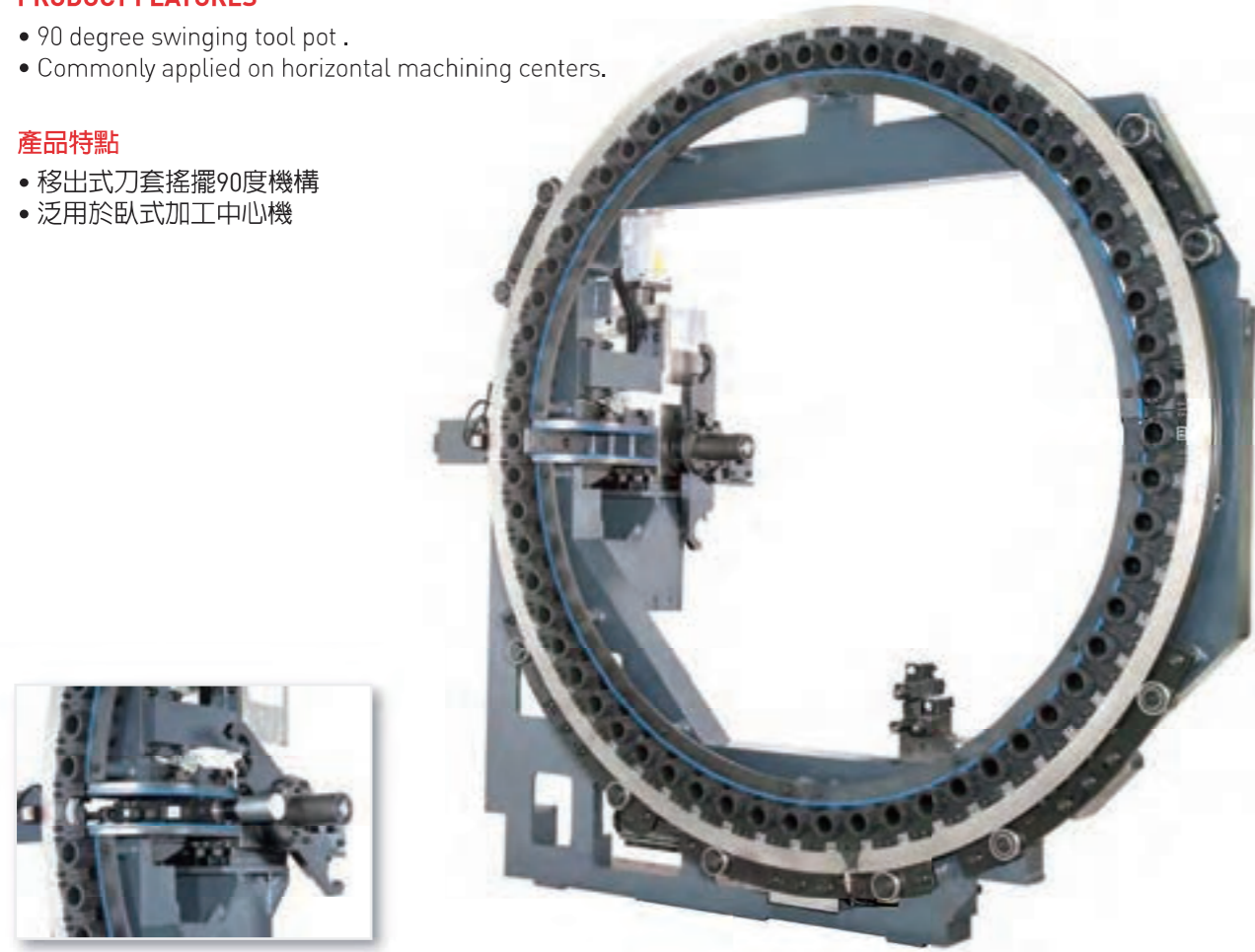

Tool Holder Type 刀具型式		BT / ISO / CAT / HSK		
Taper Type 刀把規格		40#[HSK-63]	50#[HSK-100]	
Max. Tool Weight 最大刀具重量		8	25	kg
Tool Diameter 刀具外徑	All pocket full 滿刀	Ø95	Ø125	mm
	No Adjacent Tool 鄰空刀	Ø150	Ø250	
Tool Capacity 刀具數量		40 / 60		T
Power Supply of Magazine 刀庫動力源		Electric / Servo 電機/伺服		
Tool Changing Mechanism 換刀機構		Cam-type tool changing mechanism 凸輪式換刀機構		
Degree Guiding Mechanism 分度導引機構		Embedded roller guide, arc track, bearing guide 滾輪嵌入式軸向導引		

Horizontal Radical-Type Tool Changer

圓盤臥式放射狀快速換刀刀庫

PRODUCT FEATURES

- Radical tool pot for horizontal tool changing.
- Vertical shifting-out mechanism for tool pot.
- Equipped with high-speed tool changing mechanism.
- Equipped with oil pan.
- Commonly applied on horizontal machining centers.

產品特點

- 臥式放射狀刀套結構
- 刀套垂直移出機構
- 搭配快速型換刀機構
- 盛油水盤板金
- 泛用於臥式加工中心機

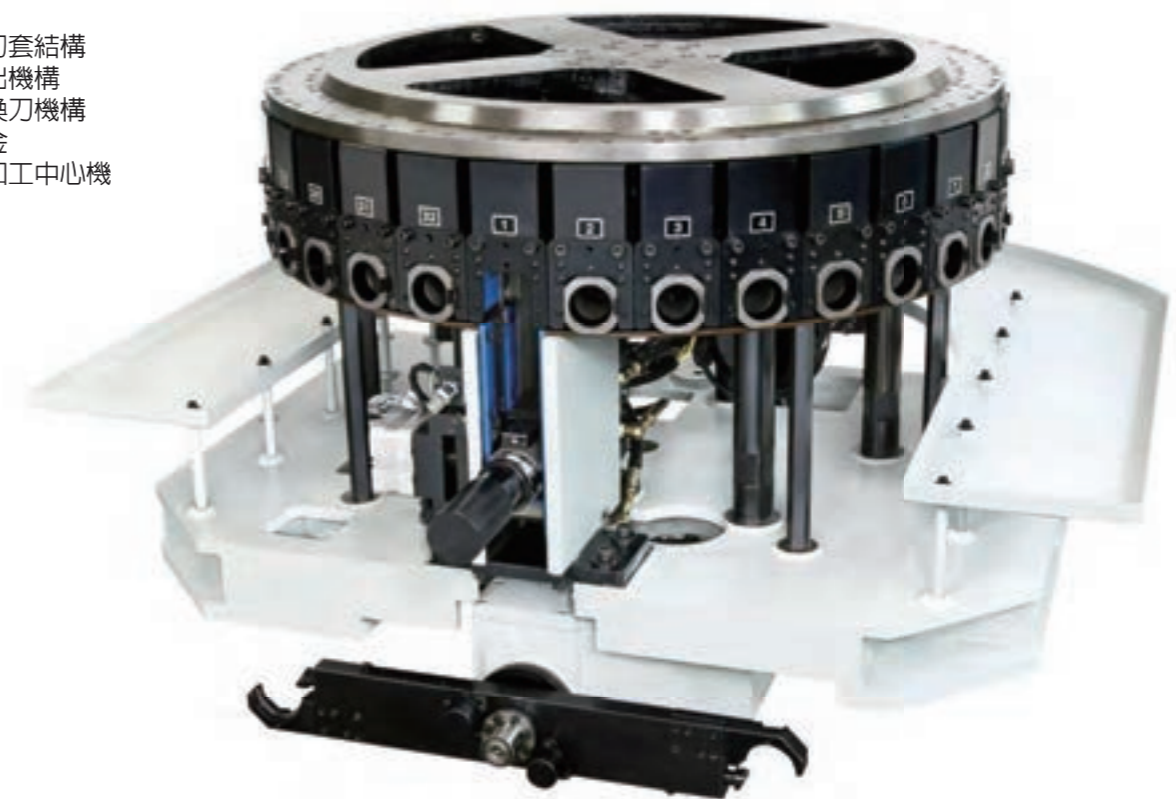

Tool Holder Type 刀具型式		BT / ISO / CAT / HSK-63		
Taper Type 刀把規格		40#		
Max. Tool Weight 最大刀具重量		8		kg
Tool Diameter 刀具外徑	All pocket full 滿刀	Ø85		mm
Tool Capacity 刀具數量		24 / 32		T
Power Supply of Magazine 刀庫動力源		Servo 伺服		
Tool Changing Mechanism 換刀機構		Cam-type changing mechanism 凸輪式換刀機構		

HORIZONTAL TYPE ATC / DISC TYPE

臥式換刀刀庫 / 圓盤刀庫

Horizontal Disc-Type Tool Changer

圓盤臥式快速換刀刀庫

PRODUCT FEATURES

- Equipped with high-speed tool changing mechanism.
- Commonly applied on horizontal machining centers.

產品特點

- 搭配快速型換刀機構
- 泛用於臥式加工中心機

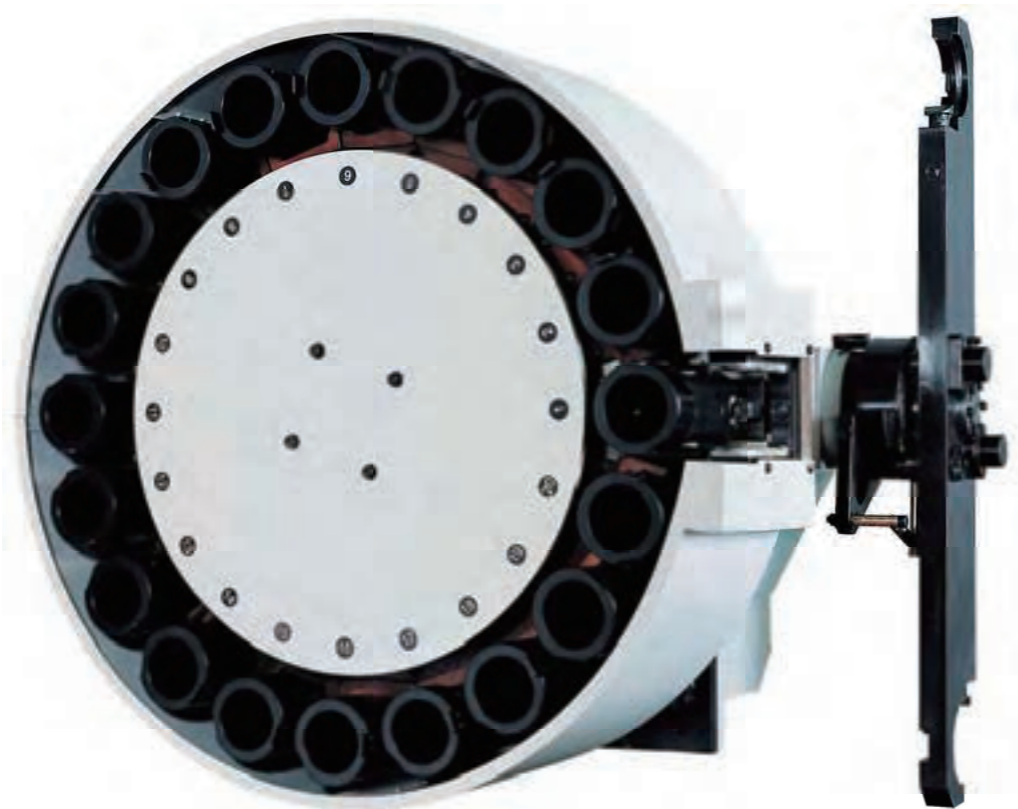

Tool Holder Type 刀具型式		BT / ISO / CAT / HSK			
Taper Type 刀把規格		30#	40#	50#(HSK-100)	
Max. Tool Weight 最大刀具重量		3	8	15	kg
Tool Diameter 刀具外徑	All pocket full 滿刀	Ø65	Ø80	Ø110	mm
	No Adjacent Tool 鄰空刀	Ø130	Ø130	Ø220	
Tool Capacity 刀具數量		16 / 20 / 24			T
Power Supply Of Magazine 刀庫動力源		Electric 電機			
Tool Changing Mechanism 換刀機構		Electric 電機			

Horizontal Disc-Type Tool Changer

圓盤臥式快速換刀刀庫

PRODUCT FEATURES

- Tool changing mechanism is assembled at the opposite side to tool magazine.
- Equipped with high speed tool changing mechanism.
- Commonly applied on horizontal machining centers.

產品特點

- 對向式換刀設計
- 搭配快速型換刀機構
- 泛用於臥式加工中心機

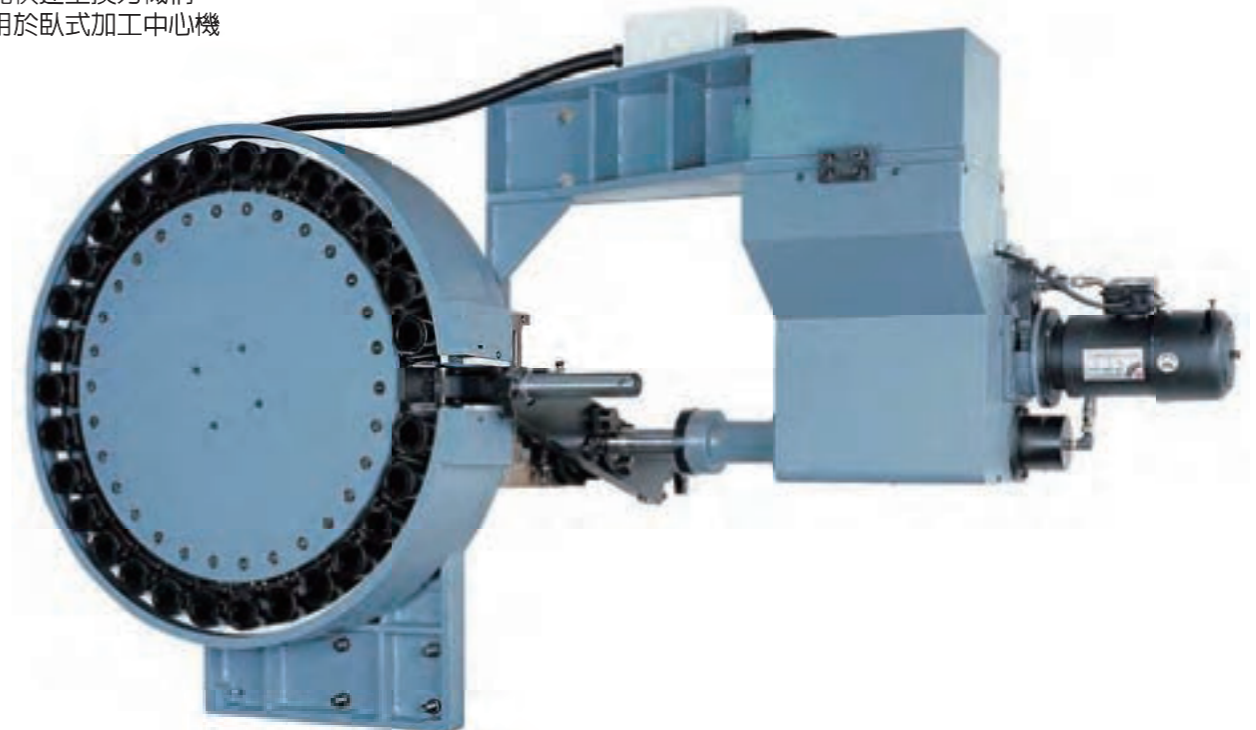

Tool Holder Type 刀具型式		BT / ISO / CAT / HSK	
Taper Type 刀把規格		40#(HSK-63)	
Max. Tool Weight 最大刀具重量		6.5	kg
Tool Diameter 刀具外徑	All pocket full 滿刀	Ø80	
		mm	
Tool Capacity 刀具數量		30	T
Power Supply Of Magazine 刀庫動力源		Electric 電機	
Tool Changing Mechanism 換刀機構		Electric 電機	

VERTICAL TYPE ATC / CHAIN TYPE

立式換刀刀庫 / 鏈式刀庫

Upward-Vertical-Type Tool Changer

朝天式換刀刀庫

PRODUCT FEATURES

- Parallel shifting mechanism is driven by servo motor.
- Expandable tool magazine.
- Commonly applied on double-column machining centers.

產品特點

- 伺服驅動之線性滑軌平移機構
- 擴充式刀倉結構
- 泛用於龍門加工中心機

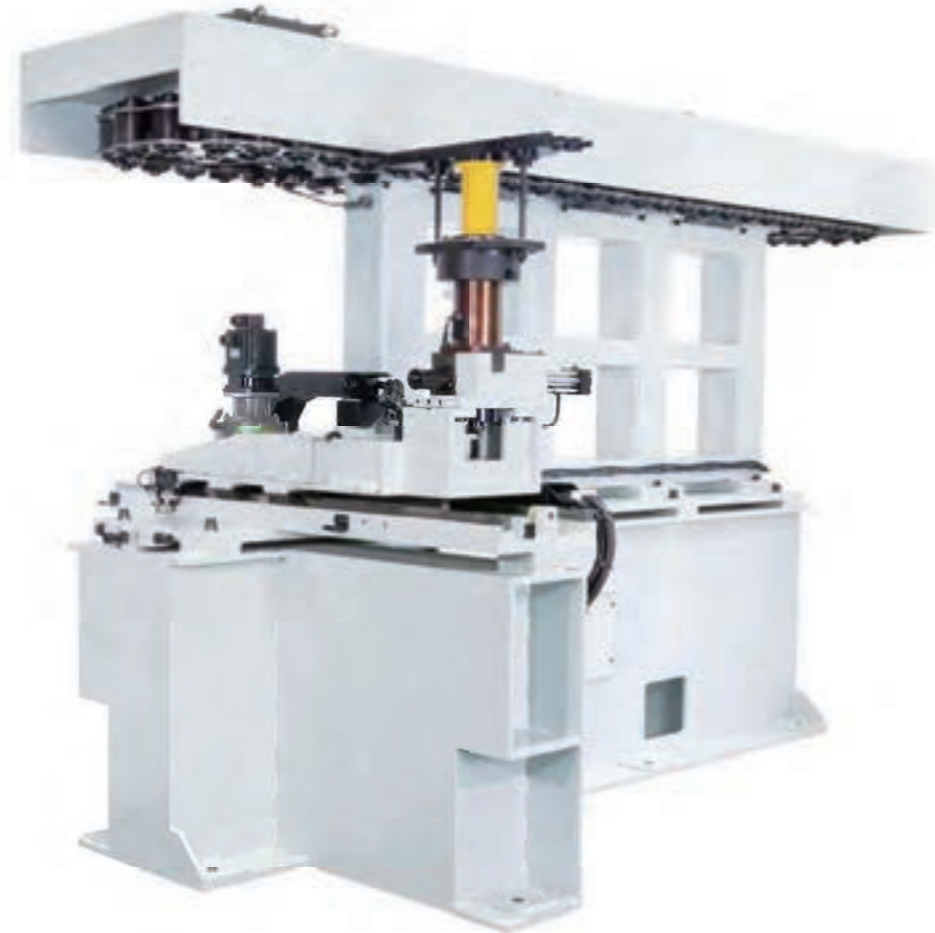

Tool Holder Type 刀具型式		BT / ISO / CAT / HSK		
Taper Type 刀把規格		40#(HSK-63)	50#(HSK-100)	
Max. Tool Weight 最大刀具重量		10	25	kg
Tool Diameter 刀具外徑	All pocket full 滿刀	Ø95	Ø125、Ø175	
	No Adjacent Tool 鄰空刀	Ø130	Ø200	
Tool Capacity 刀具數量		30 / 32 / 40 / 60 / 80 / 90 / 100		
Power Supply of Magazine 刀庫動力源		Hydraulic / Servo / Electric 油壓/伺服/電機		
Tool Changing Mechanism 換刀機構型式		Hydraulic rack / Servo 油壓齒條/伺服		

Upward-Vertical-Type Tool Changer

朝天式換刀刀庫

PRODUCT FEATURES

- Parallel shifting mechanism is driven by hydraulic motor.
- Expandable tool magazine.
- Commonly applied on double-column machining centers.

產品特點

- 油壓驅動之線性滑軌平移機構
- 擴充式刀倉結構
- 泛用於龍門加工中心機

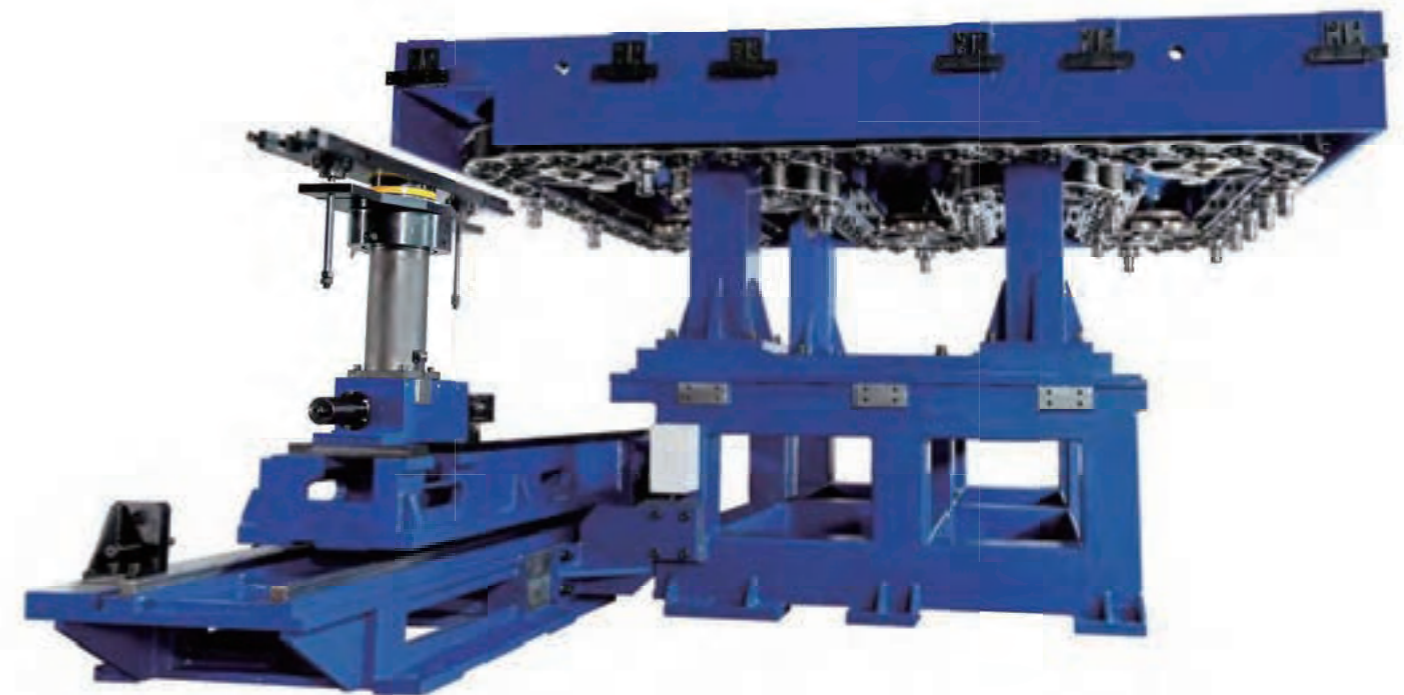

Tool Holder Type 刀具型式		BT / ISO / CAT / HSK		
Taper Type 刀把規格		40#(HSK-63)	50#(HSK-100)	
Max. Tool Weight 最大刀具重量		10	25	kg
Tool Diameter 刀具外徑	All pocket full 滿刀	Ø95	Ø125	
	No Adjacent Tool 鄰空刀	Ø130	Ø200	
Tool Capacity 刀具數量		40 / 60 / 90 / 100		
Power Supply of Magazine 刀庫動力源		Electric / Hydraulic / Servo 電機/油壓/伺服		
Tool Changing Mechanism 換刀機構		Hydraulic rack / Servo 油壓齒條/伺服		

VERTICAL TYPE ATC / CHAIN TYPE

立式換刀刀庫 / 鏈式刀庫

Vertical Chain-Type Tool Changer

立式快速換刀刀庫

PRODUCT FEATURES

- Parallel shifting mechanism is driven by servo motor.
- Expandable tool magazine.
- Commonly applied on double-column machining centers.

產品特點

- 伺服驅動之線性滑軌平移機構
- 擴充式刀倉結構
- 泛用於龍門加工中心機

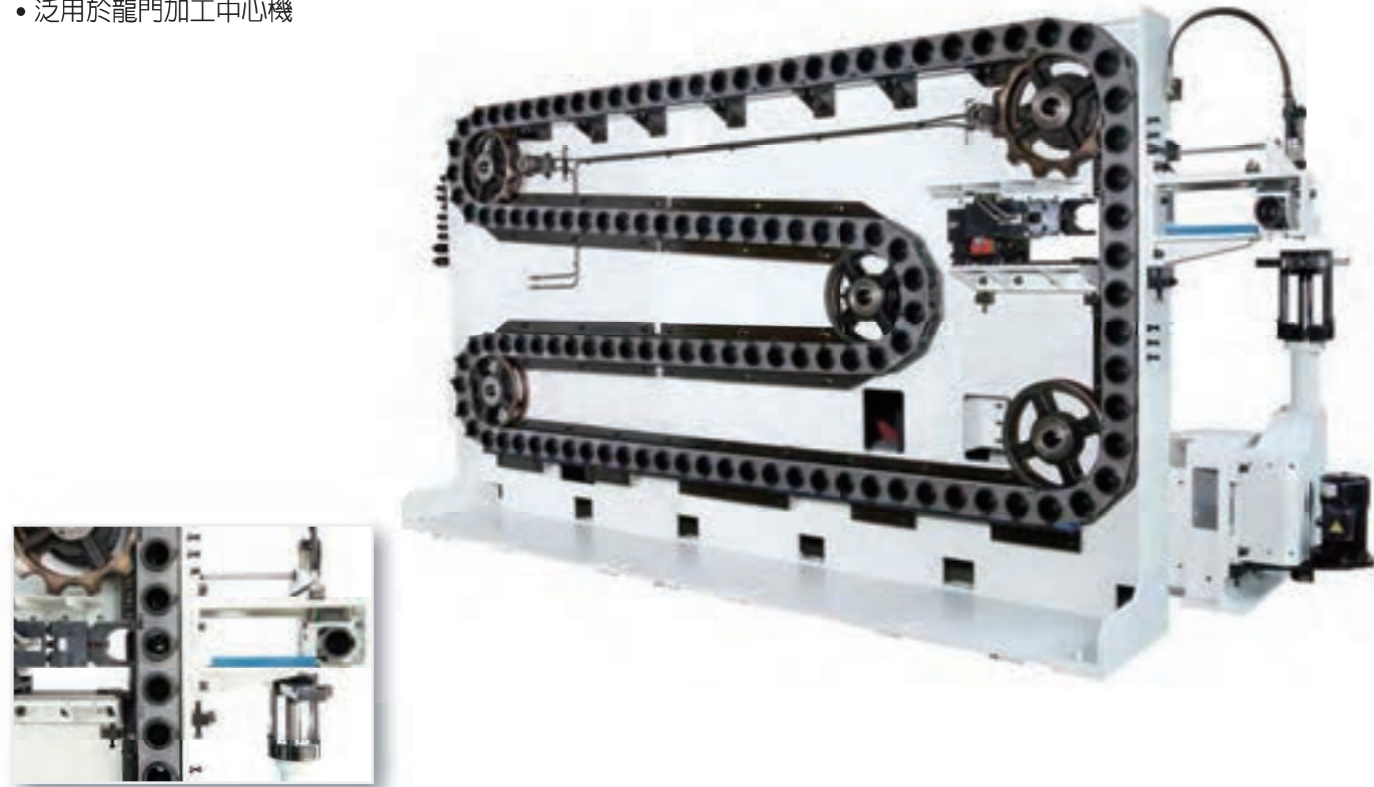

Tool Holder Type 刀具型式		BT / ISO / CAT / HSK		
Taper Type 刀把規格		40#(HSK-63)	50#(HSK-100)	
Max. Tool Weight 最大刀具重量		8, 12	25	kg
Tool Diameter 刀具外徑	All pocket full 滿刀	Ø80、Ø95	Ø125、Ø175	mm
	No Adjacent Tool 鄰空刀	Ø150、Ø180	Ø250、Ø350	
Tool Capacity 刀具數量		40 / 60 / 90 / 120		T
Power Supply of Magazine 刀庫動力源		Hydraulic / Servo 油壓/伺服		
Tool Changing Mechanism 換刀機構		Cam-type changing mechanism 凸輪式換刀機構		

Chain-Type Tool Changer

鏈式刀庫

PRODUCT FEATURES

- Modularized design.
- Commonly applied on vertical machining centers and double-column machining centers.

產品特點

- 模組化刀庫設計
- 泛用於立式加工中心機、龍門加工中心機

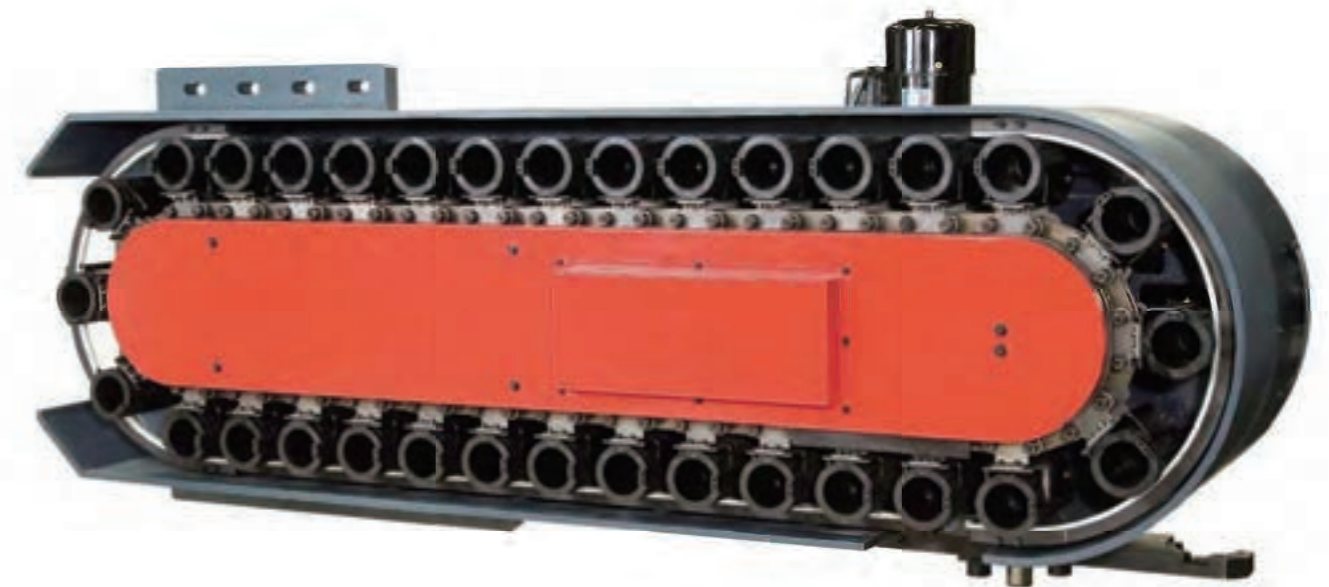

Tool Holder Type 刀具型式		BT / ISO / CAT / HSK		
Taper Type 刀把規格		40#(HSK-63)	50#(HSK-100)	
Max. Tool Weight 最大刀具重量		8	25	kg
Tool Diameter 刀具外徑	All pocket full 滿刀	Ø95	Ø125	mm
	No Adjacent Tool 鄰空刀	Ø150	Ø250	
Tool Capacity 刀具數量		24 / 32 / 40 / 50 / 60		T
Power Supply of Magazine 刀庫動力源		Electric / Servo 電機/伺服		
Tool Changing Mechanism 換刀機構		Cam mechanism (electric motor) 凸輪式機構(電機馬達)		

VERTICAL TYPE ATC / UMBRELLA TYPE

立式換刀刀庫 / 斗笠式刀庫

Carousel Tool Changer with High-Speed Shifting Mechanism (Chain Type)

鏈式快速移出式斗笠型刀庫

PRODUCT FEATURES

- Aluminum structure and spring type claw.
- The shifting mechanism is driven by hydraulic cylinder.
- Simultaneous door-open mechanism.
- Commonly applied on 5-axis machining centers, double-column machining centers and vertical machining centers

產品特點

- 鋁製刀座與彈片式夾爪
- 油壓缸驅動短距離平移機構
- 同動開門機構
- 泛用於五軸加工中心機、龍門加工中心機、立式加工中心機

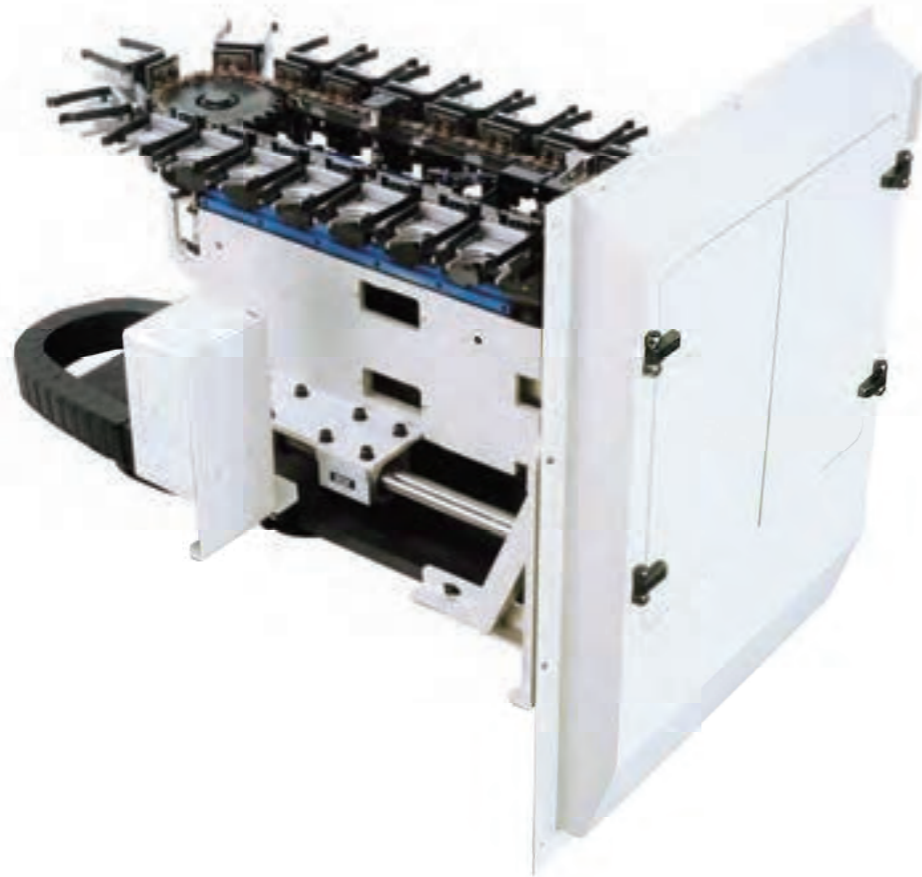

Tool Holder Type 刀具型式		BT / ISO / CAT / HSK-63	
Taper Type 刀把規格		40#	
Max. Tool Weight 最大刀具重量		8	kg
Tool Diameter 刀具外徑	All pocket full 滿刀	Ø75	mm
	No Adjacent Tool 鄰空刀	Ø120	
Tool Capacity 刀具數量		20 / 24 / 32 / 40	T
Power Supply of Magazine 刀庫動力源		Hydraulic 油壓	

Carousel Tool Changer with High-Speed Shifting Mechanism (Chain Type)

鏈式快速移出式斗笠型刀庫

PRODUCT FEATURES

- Aluminum integral forming claws.
- Commonly applied on 5-axis machining centers, double-column machining centers and vertical machining centers.

產品特點

- 鋁壓鑄一體成型刀爪
- 泛用於龍門加工中心機、五軸加工中心機、天車式龍門加工中心機

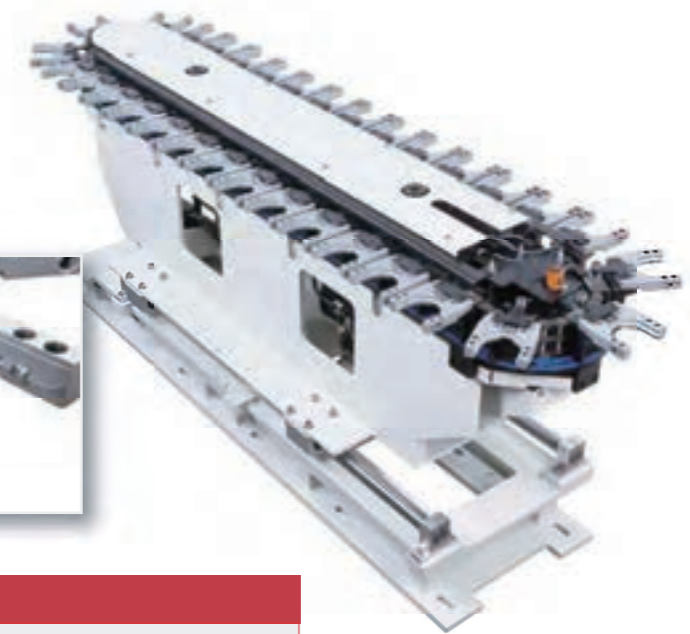

Tool Holder Type 刀具型式		BT / ISO / CAT / HSK	
Taper Type 刀把規格		40#(HSK-63)	50#(HSK-100)
Max. Tool Weight 最大刀具重量		8	15 kg
Tool Diameter 刀具外徑	All pocket full 滿刀	Ø95	mm
	No Adjacent Tool 鄰空刀	Ø125	
Tool Capacity 刀具數量		16 / 24 / 32 / 40 / 60	T
Power Supply of Magazine 刀庫動力源		Electric / Servo 電機/伺服	
Shifting Mechanism 平移機構		Hydraulic linear guide 油壓線軌	

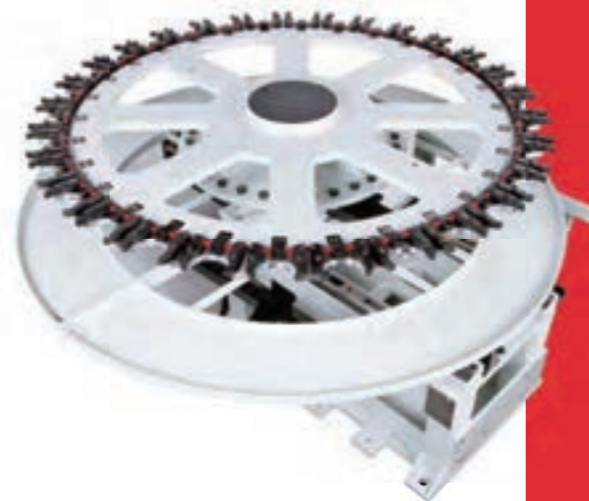

Carousel Tool Changer with Moving Mechanism (Disc Type)

立式斗笠型快速移出式刀庫

PRODUCT FEATURES

- Equipped with oil pan.
- The shifting mechanism is driven by hydraulic cylinder.
- Commonly applied on 5-axis machining centers and double-column machining centers.

產品特點

- 盛油水盤板金設計
- 油壓缸驅動、線性滑軌快速移出式結構
- 泛用於五軸加工機、(天車式)龍門加工中心機

Tool Holder Type 刀具型式		BT / ISO / CAT / HSK	
Taper Type 刀把規格		40#(HSK-63)	50#(HSK-100)
Max. Tool Weight 最大刀具重量		7	15 kg
Tool Diameter 刀具外徑	All pocket full 滿刀	Ø100	mm
	No Adjacent Tool 鄰空刀	Ø300	
Tool Capacity 刀具數量		12 / 14 / 16 / 24 / 30	T
Power Supply of Magazine 刀庫動力源		Electric / Servo 電機/伺服	
Shifting Mechanism 平移機構		Hydraulic linear guide 油壓線軌	

VERTICAL TYPE ATC / UMBRELLA TYPE

立式換刀刀庫 / 斗笠式刀庫

Elevating Carousel Tool Changer (Disc Type)

圓盤升降式斗笠型刀庫

PRODUCT FEATURES

- Specialized for vertical lathe with overweight turning tools.
- Equipped with hydraulic elevating stabilized device.
- Commonly applied on vertical lathes.

產品特點

- 立車超重刀架專用刀庫
- 搭載油壓升降穩定裝置
- 泛用於立式車床



Tool Holder Type 刀具型式	AS REQUIRED	
Max. Tool Weight 最大刀具重量	150、265	kg
External diameter of Tool 刀具最大外徑	Ø520	mm
Tool Capacity 刀具數量	12	T
Power Supply of Magazine 刀庫動力源	Servo 伺服	
Elevating Mechanism 升降機構	Hydraulic track, counterweight mechanism 油壓線軌、配重機構	

Double-Layer Carousel Tool Changer (Disc Type)

圓盤複合式斗笠型刀庫

PRODUCT FEATURES

- The double-layer of tool carriers are driven by two servo motors individually.
- Both turning tools and milling tools can be placed on this design.
- Commonly applied on vertical lathes.

產品特點

- 雙層式刀盤結構，雙伺服獨立驅動源
- 立式車刀或銑刀混合設計
- 泛用於大型立式車床



Tool Holder Type 刀具型式	AS REQUIRED		
Max. Tool Weight 最大刀具重量	上層Upper Layer 400	kg	
	底層Lower Layer 670		
External diameter of Tool 刀具最大外徑	Ø400	mm	
Tool Capacity 刀具數量	Upper layer 上層	5	T
	Lower layer 底層	7	
Tool magazine drive source 換刀機構動力源	Servo 伺服		

VERTICAL TYPE ATC / DISC TYPE 立式換刀刀庫 / 圓盤刀庫

Vertical Disc-Type Tool Changer 立式圓盤快速換刀刀庫

PRODUCT FEATURES

- Mechanic linkage between spindle and tool unloading mechanism.
- Tool catching mechanism with nonimpact arm.
- High-speed tool changing mechanism. t-t: 0.7 sec.
- Modularized structure.
- Commonly applied on vertical machining centers.

產品特點

- 機械連桿與主軸同動打刀機構
- 無撞擊型刀臂扣刀機構
- 搭載快速型換刀機構，換刀秒數:0.7秒
- 模組化結構
- 泛用於立式加工中心機



Tool Holder Type 刀具型式		BT / ISO / CAT / HSK50E		
Taper Type 刀把規格		30#		
Max. Tool Weight 最大刀具重量		3		kg
Tool Diameter 刀具外徑	All pocket full 滿刀	Ø80	Ø65	mm
	No adjacent tool 鄰空刀	Ø130	Ø130	
Tool Capacity 刀具數量		16	20 / 24 / 30	T
Power Source of Magazine 刀庫動力源		Electric / Servo 電機/伺服		
Tool Changing Mechanism 自動換刀機構型式		Cam type tool changing mechanism with linkages 連桿同動凸輪式換刀機構		

Vertical Disc-Type Tool Changer 立式圓盤快速換刀刀庫

PRODUCT FEATURES

- Tool disc : light-weight& modularized structure.
- Mechanic simultaneous tool unloading mechanism.
- Commonly applied on vertical machining centers.

產品特點

- 輕量化、模組化之積木式刀盤結構
- 機械式同動打刀機構
- 泛用於立式加工中心機



Tool Holder Type 刀具型式		BT / ISO / CAT / HSK-63		
Taper Type 刀把規格		40#		
Max. Tool Weight 最大刀具重量		8		kg
Tool Diameter 刀具外徑	All pocket full 滿刀	Ø80		mm
	No Adjacent Tool 鄰空刀	Ø130		
Tool Capacity 刀具數量		16 / 24 / 30		T
Power Source of Magazine 刀庫動力源		Electric 電機		
Tool Changing Mechanism 自動換刀機構型式		Cam mechanism (electric motor) 凸輪式換刀機構 (電機馬達)		

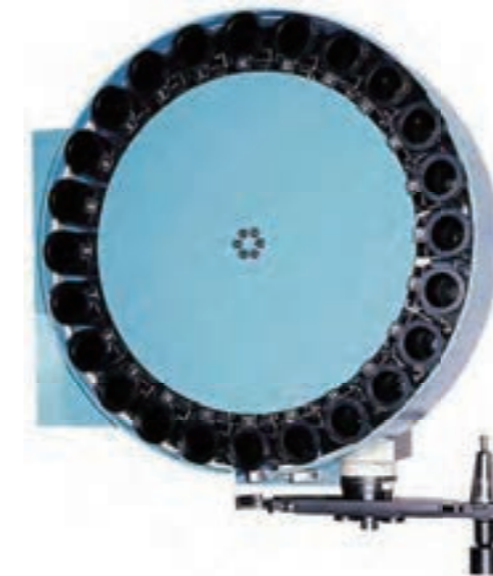

Vertical Disc-Type Tool Changer 圓盤立式快速換刀刀庫

PRODUCT FEATURES

- Modularized structure.
- Commonly applied on vertical machining centers and double-column machining centers.

產品特點

- 模組化結構
- 泛用於立式加工中心機、龍門加工中心機

Tool Holder Type 刀具型式		BT / ISO / CAT / HSK-100			
Taper Type 刀把規格		50#			
Max. Tool Weight 最大刀具重量		25			kg
Tool Diameter 刀具外徑	All pocket full 滿刀	Ø125	Ø110	Ø110	mm
	No Adjacent Tool 鄰空刀	Ø250	Ø220	Ø220	
Tool Capacity 刀具數量		20 T	24T	30T	T
Power Source of Magazine 刀庫動力源		Electric motor 電機馬達			
Tool Changing Mechanism 自動換刀機構型式		Cam mechanism (electric motor) 凸輪式換刀機構 (電機馬達)			