

Directional spool valve type CWPN

Product documentation

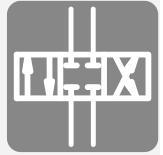

Manifold mounting valve, nominal size 6

Operating pressure p_{\max} :

315 bar

Flow rate Q_{\max} :

60 lpm

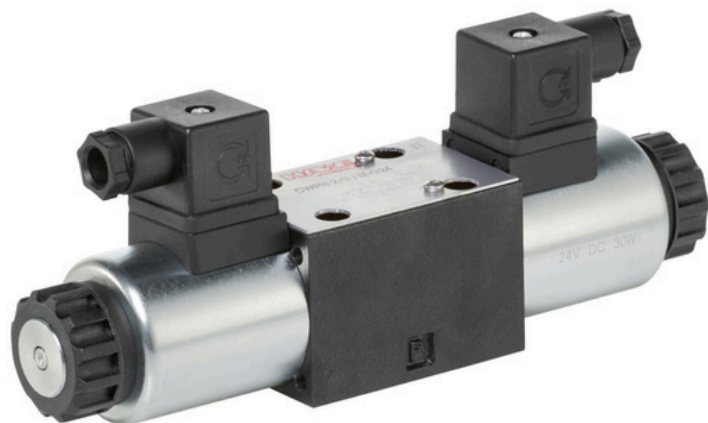

© by HAWE Hydraulik SE.

The reproduction and distribution of this document as well as the use and communication of its contents to others without explicit authorization is prohibited.

Offenders will be held liable for the payment of damages.

All rights reserved in the event of patent or utility model applications.

Brand names, product names and trademarks are not specifically indicated. In particular with regard to registered and protected names and trademarks, usage is subject to legal provisions.

HAWE Hydraulik respects these legal provisions in all cases.

HAWE Hydraulik cannot provide individual guarantees that the stated circuits or procedures (including in part) are not subject to the intellectual property rights of third parties.

Printing date / document generated on: 03.02.2022

Table of Contents

1	Overview of the directional spool valve type CWPN.....	4
2	Available versions.....	5
2.1	Basic type and size.....	5
2.2	Circuit symbols.....	5
2.3	Actuation.....	7
2.3.1	Electrical actuation.....	7
2.3.2	Manual actuation.....	7
2.4	Additional valves in port P.....	7
2.5	Solenoid voltage and connector.....	8
3	Parameters.....	9
3.1	General data.....	9
3.2	Weight.....	9
3.3	Pressure and volumetric flow.....	10
3.4	Characteristic lines.....	10
3.5	Electrical data.....	12
4	Dimensions.....	13
4.1	Standard version without manual actuation.....	13
4.2	Version with manual actuation.....	15
4.3	Hole pattern of the base plate.....	17
5	Installation, operation and maintenance information.....	18
5.1	Intended use.....	18
5.2	Assembly information.....	18
5.3	Operating instructions.....	18
5.4	Maintenance information.....	19
6	Other information.....	20
6.1	Accessories, spare and individual parts.....	20

1**Overview of the directional spool valve type CWPN**

Directional spool valves are a type of directional valve. They control the direction of movement and the velocity of single and double-acting hydraulic consumers.

The directional spool valve type CWPN is a 4/3- or 4/2-way directional valve with standard connection pattern NG 6 (CETOP 03). It is directly actuated and a binary valve.

The directional spool valve type CWPN can be flexibly combined with the common HAWE valve banks and compact hydraulic power packs. It can also be mounted on customer-specific manifolds or sub-plates.

Features and benefits

- Universally usable thanks to standard connection pattern NG 6 (CETOP 3) according to ISO 4401-03 or DIN 24 340-A6
- Modular system with various circuit symbols and actuation variants
- Optionally also available with additional valves in port P

Intended applications

- Machine tools
- Wind turbines
- Solar power plants
- Industrial hydraulics

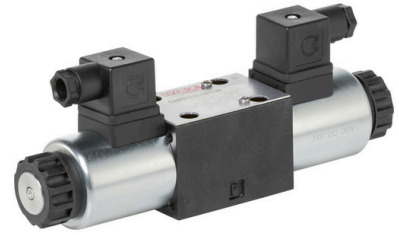

Directional spool valve type CWPN

2 Available versions

Ordering example

CWPN 06	G	/ MHA	/ B 0,8	-G 24
	2.2 "Circuit symbols"	2.3 "Actuation"	2.4 "Additional valves in port P"	2.5 "Solenoid voltage and connector"
2.1 "Basic type and size"				

2.1 Basic type and size

Type	Flow rate Q_{max} (lpm)	Operating pressure p_{max} (bar)
CWPN 06	60	315

! DAMAGE

Depending on the pressure, the maximum switchable flow rate may be lower.
see Chapter 3.4, "Characteristic lines"

2.2 Circuit symbols

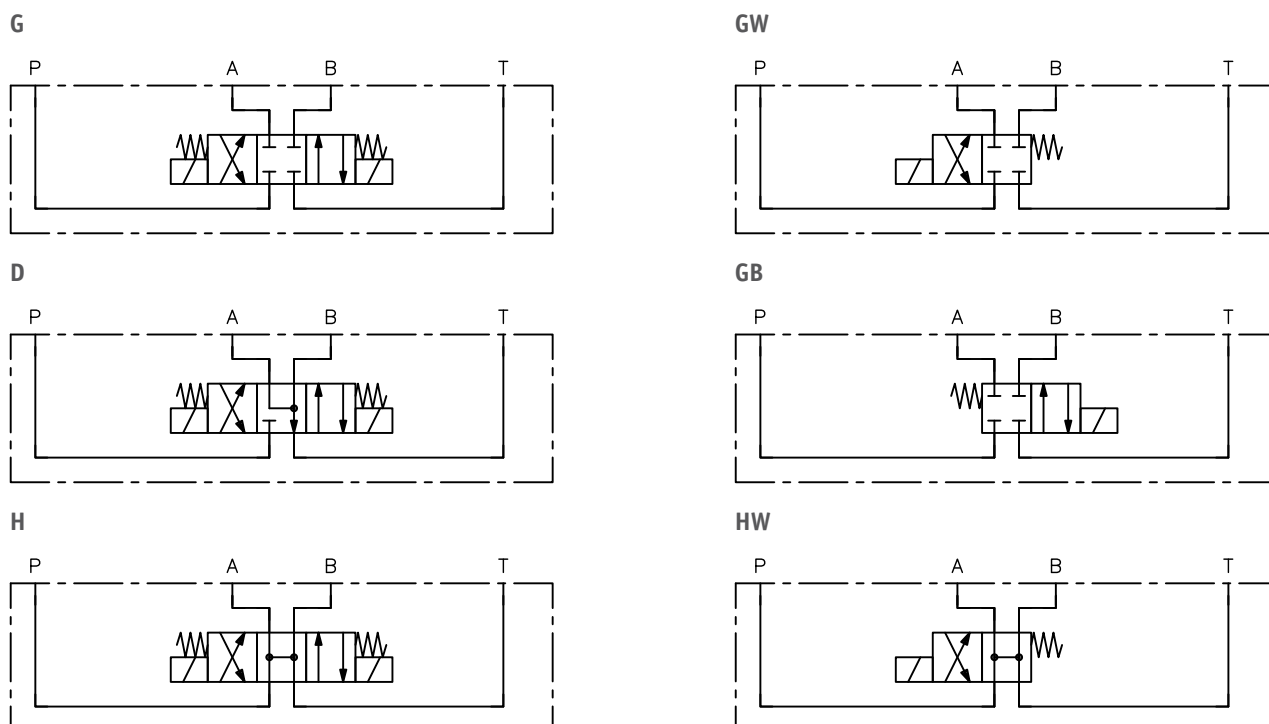

L

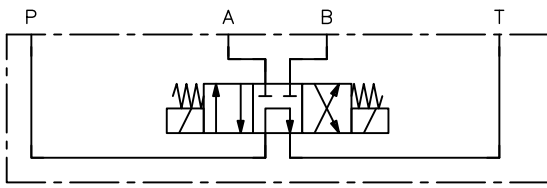

X

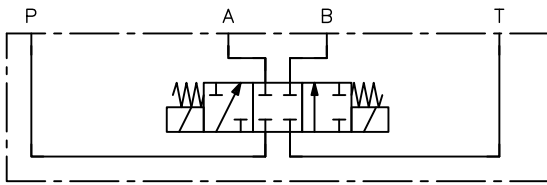

C

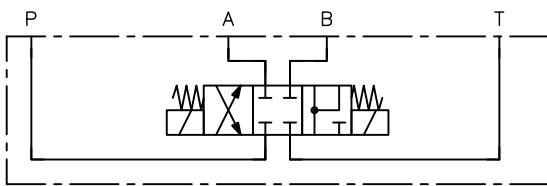

E

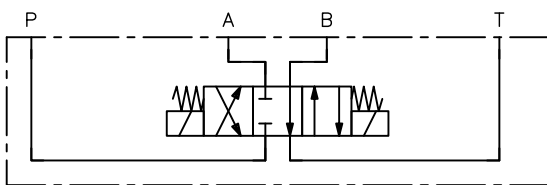

O

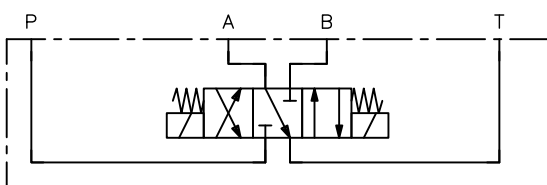

HB

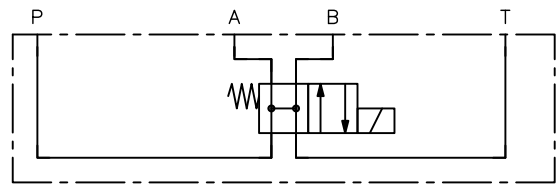

W

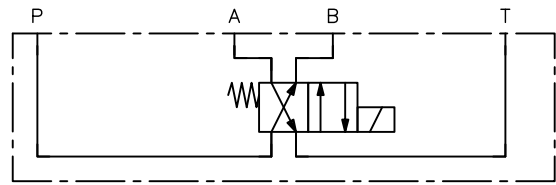

B

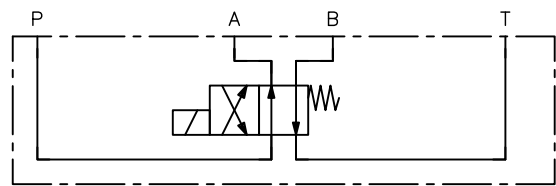

R

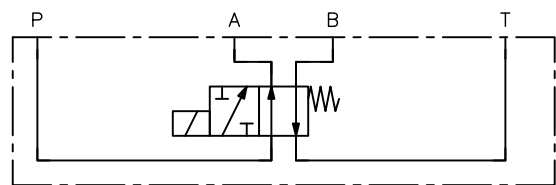

V

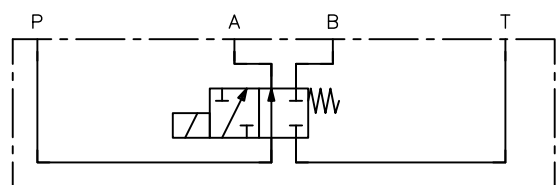

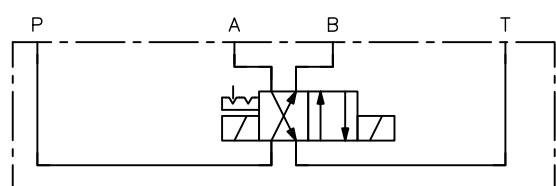

K



2.3 Actuation

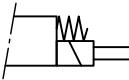

2.3.1 Electrical actuation

Coding	Description	Circuit symbol
M	Electrical actuation	
MT	Electrical actuation with manual override	
MS	Electrical actuation with soft-shift function. The armature of the solenoid is fitted with an orifice, which has the effect of extending the switching time of the type CWPN directional spool valve. This avoids switching shocks.	

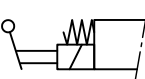
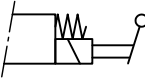
2.3.2 Manual actuation

Coding	Description	Circuit symbol
Without coding	Without manual actuation (standard version)	--
HA	Manual actuation on A-side Only in conjunction with <ul style="list-style-type: none"> ▪ Circuit symbol G, D, H, L, X, C, E, O, GW, B, HW, R or V 	
HB	Manual actuation on B-side Only in conjunction with <ul style="list-style-type: none"> ▪ Circuit symbol G, D, H, L, X, C, E, O, W, GB or HB 	

2.4 Additional valves in port P

Coding	Description	Circuit symbol
Without coding	Without additional valve in P	--
B 0,8 B 1,0 B 1,2 B 1,5 B 2,0	orifice in port P with orifice \varnothing between 0.8 and 2.0 mm according to coding	
R	Check valve in port P	

2.5 Solenoid voltage and connector

Coding	Electrical connection	Nominal voltage	Protection class (IEC 60529)
X 12 X 24	EN 175 301-803 A	12 V DC 24 V DC	IP 65
G 12 G 24	<ul style="list-style-type: none"> ▪ X: without male connector ▪ G: with male connector (MSD 3-309 according to D 7163) ▪ L: with male connector with LED (SVS 296365 according to D 7163) 		
L 12 L 24			
X 98 X 205	EN 175 301-803 A	98 V DC 205 V DC	IP 65
WG 110 WG 230	<ul style="list-style-type: none"> ▪ X: without male connector ▪ WG: with male connector with rectifier (MSD 4-209 P10 according to D 7163) 	110 V AC 50/60 Hz 230 V AC 50/60 Hz	
AMP 12 AMP 24	AMP Junior Timer	12 V DC 24 V DC	IP 67
DT 12 DT 24	German (DT 04-2P)	12 V DC 24 V DC	IP 69k

The specifications regarding the IP protection class apply for versions featuring a properly assembled male connector.

3 Parameters

3.1 General data

Designation	Directional spool valve
Design	Spool valve, directly actuated
Model	Single valve for manifold mounting
Installation position	Any
Flow direction	According to arrow direction in circuit symbols
Ports/connections	<ul style="list-style-type: none"> ▪ P = Pump ▪ A, B = Consumers ▪ T = Tank
Material	Steel/cast Zn-Ni coated, Electro-galvanised solenoids
Hydraulic fluid	Hydraulic fluid, according to DIN 51 524 Parts 1 to 3; ISO VG 10 to 68 according to DIN ISO 3448 Viscosity range: 4 - 800 mm ² /s Optimal operating range: approx. 10 - 500 mm ² /s Also suitable for biologically degradable hydraulic fluids type HEPG (polyalkylene glycol) and HEES (synthetic ester) at operating temperatures up to approx. +70°C. Not suitable for HETG such as rapeseed oil and water-glycol solutions, e.g. HFA and HFC.
Cleanliness level	ISO 4406 <u>20/17/14</u>
Temperatures	Environment: approx. -40 to +80 °C, hydraulic fluid: -25 to +80 °C, pay attention to the viscosity range. Start temperature: down to -40 °C is permissible (take account of the start viscosities!), as long as the steady-state temperature is at least 20 K higher during subsequent operation. Biologically degradable hydraulic fluids: note manufacturer specifications. With consideration for the seal compatibility, not above +70°C.

3.2 Weight

Circuit symbol G, D, H, L, X, C, E, O, K	2.0 kg
Circuit symbol GW, GB, HW, HB, W, B, R, V	1.8 kg
HA or HB actuation	+ 0.6 kg

3.3 Pressure and volumetric flow

Operating pressure

$p_{\max} = 315$ bar (ports P, A, B)
Return pressure ≤ 210 bar (port T), or ≤ 50 bar for HA or HB actuation

Flow rate

$Q_{\max} = 60$ lpm
Depending on the pressure, the maximum switchable flow rate may be lower.
see Chapter 3.4, "Characteristic lines"

3.4 Characteristic lines

Viscosity of the hydraulic fluid approx. $60 \text{ mm}^2/\text{s}$

Flow resistance

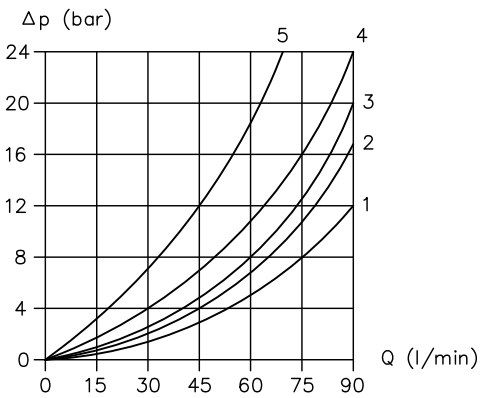

Q flow rate (lpm); Δp pressure difference (bar)

Circuit symbol	Flow direction				
	P → A	P → B	A → T	B → T	P → T
H, HW, HB	1	1	2	2	3
G, GW, GB	3	2	2	2	
D	3	3	1	1	
L	5	5	2	2	4
B, K, W	3	3	3	3	
E, O, R	3	3	3	3	
V	5	5			
X	3	3			

Flow resistance per control edge:

The characteristic lines always apply to the specified flow direction. For 4/3 or 4/2 directional spool valves, the overall resistance Δp , measured at input P, is composed of the inflow side element Δp_{in} and the outflow side element Δp_{out} . Here it is to be noted that on loads with a cylinder area ratio not equal to one φ (differential cylinders) the return flow Q_{out} may be less than or greater than the inflow Q_{in} , depending on the direction of movement!

$$\Delta p = \Delta p_{in} + \frac{\Delta p_{out}}{\varphi}$$

$$Q_{out} = \frac{Q_{in}}{\varphi}$$

$$\Delta p = \Delta p_{in} + \Delta p_{out} \cdot \varphi$$

$$Q_{out} = Q_{in} \cdot \varphi$$

$$\varphi = \frac{A_1}{A_3}$$

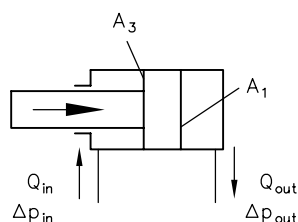
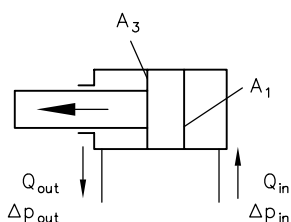

Δp = Overall resistance

Δp_{in} = Pressure loss inflow side

Δp_{out} = Pressure loss outlet side

Q_{in} = Flow rate inflow side

Q_{out} = Flow rate outlet side

φ = Cylinder area ratio

A_1 = Area piston side

A_3 = Area rod side

Switchable flow rates

DC voltage

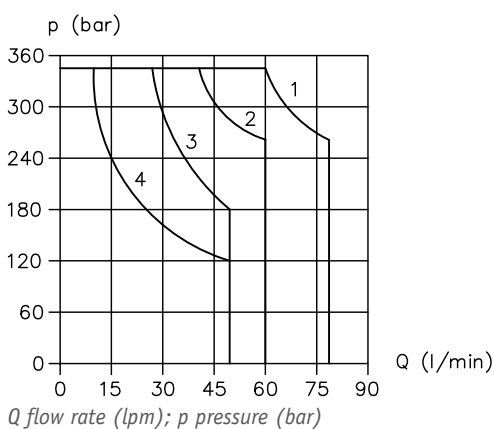

AC voltage

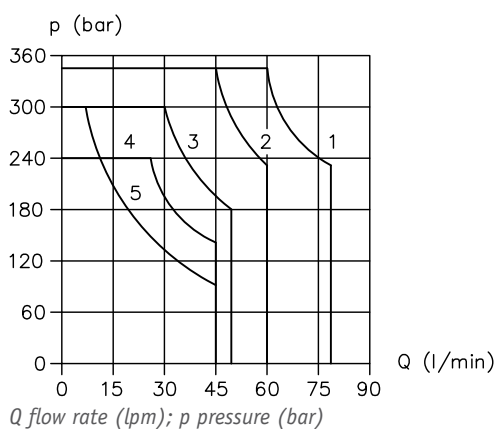

Curve	DC voltage	AC voltage
1	G, GW, GB, D, W, B, H, HW, HB, K	B, G, GW, GB, W, K
2	E, O, R	H, HW, HB
3	C, L	D
4	V, X	C, E, L, O, R
5		V, X

DAMAGE

In the event of unilateral flow, values may be significantly lower than those shown.

3.5 Electrical data

Coding	X 12 G 12 L 12 AMP 12 DT 12	X 24 G 24 L 24 AMP 24 DT 24	WG 110	WG 230
Nominal voltage	12 V DC	24 V DC	110 V AC	230 V AC
Permissible voltage deviation	10%			
Nominal current I_N	2.50 A	1.25 A	0.28 A	0.15 A
Nominal power P_N	30 W	30 W	27.5 W	29.5 W
Duty cycle	S1 (100%)			
Switching times	Circuit symbol G: on = approx. 50 ms and off = approx. 80 ms			
Switching frequency	approx. 15,000 switches/h			
Insulation material class	H			
Contact temperature	max. 100°C at 20°C ambient temperature			

Electrical connection

EN 175 301-803 A
IP 67 (IEC 60529)



X 12, X 24
G 12, G 24

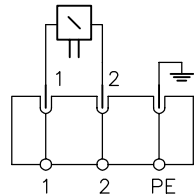

L 12, L 24

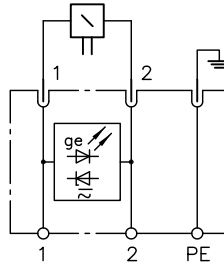

WG 110, WG 230

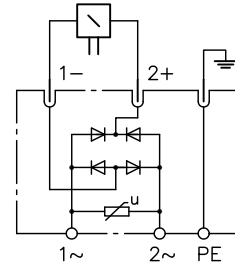

AMP 12, AMP 24

AMP Junior Timer
2-pin
IP 67 (IEC 60529)

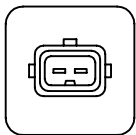

DT 12, DT 24

Deutsch (DT 04-2P)
2-pin
IP 69k (IEC 60529)

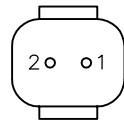

The specifications regarding the IP protection class apply for versions featuring a properly assembled male connector.

4 Dimensions

All dimensions in mm, subject to change.

4.1 Standard version without manual actuation

4/3-way directional valve

Circuit symbol **G, D, H, L, X, C, E, O, K**

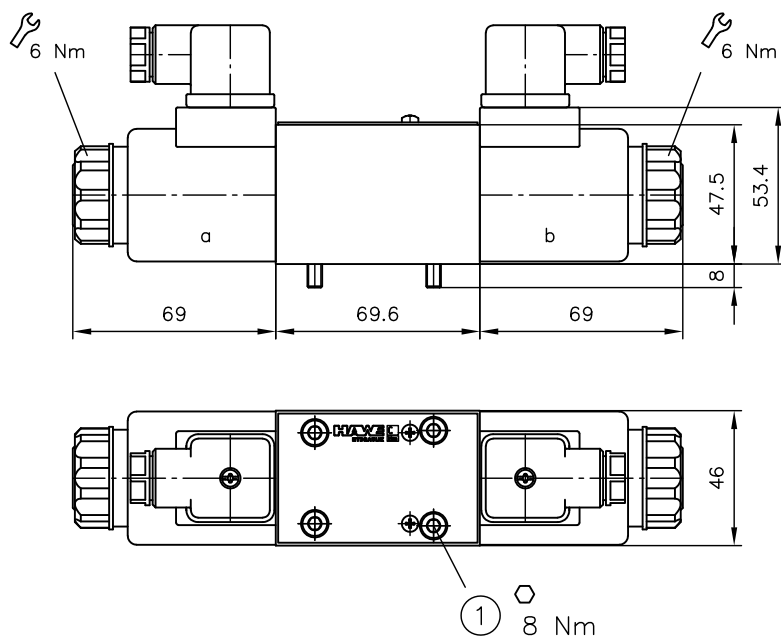

1 Cylinder screws M5x30-12.9 DIN EN ISO 4762 galvanized (not included)

4/2-way directional valve

Circuit symbol **GW, HW, B, R, V**

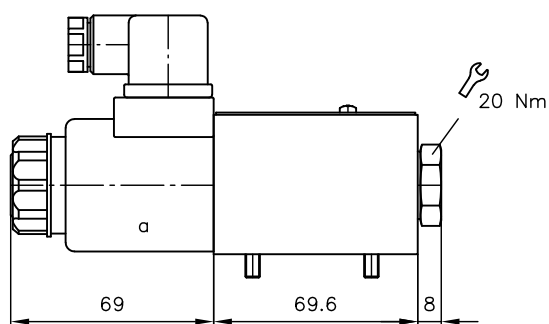

Circuit symbol **GB, HB, W**

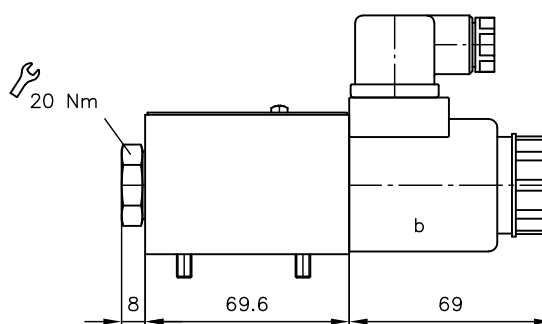

Actuation

Actuation M

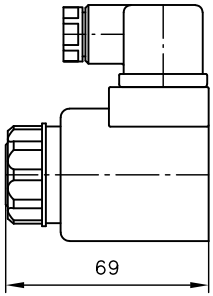

Actuation MT

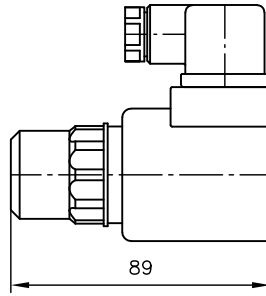

Actuation MS

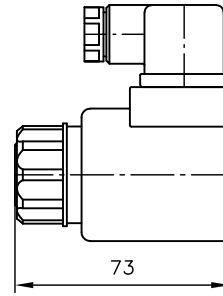

Emergency actuation

M, MS

Auxiliary tool for actuation
(do not use sharp-edged parts)

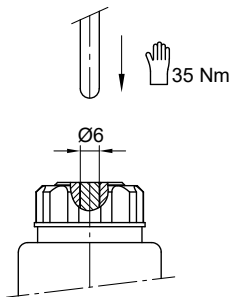

MT

Manual operation with push-button

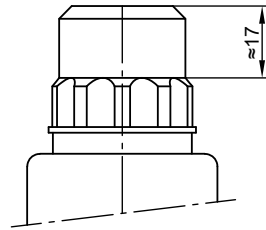

Solenoid version

X 12, X 24
X 98, X 205

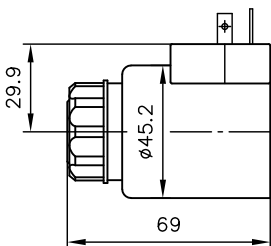

G 12, G 24

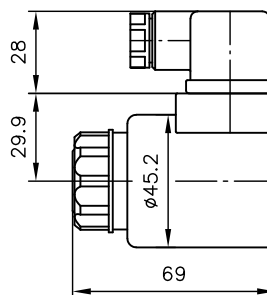

L 12, L 24

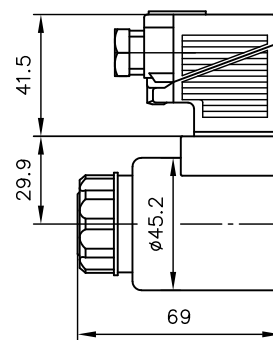

AMP 12, AMP 24

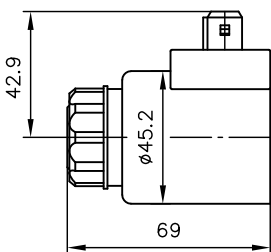

DT 12, DT 24

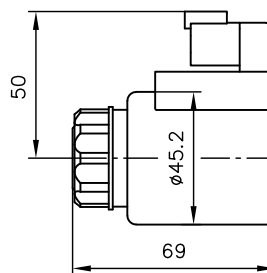

4.2 Version with manual actuation

4/3-way directional valve

Circuit symbol **G, D, H, L, X, C, E, O** with HA actuation

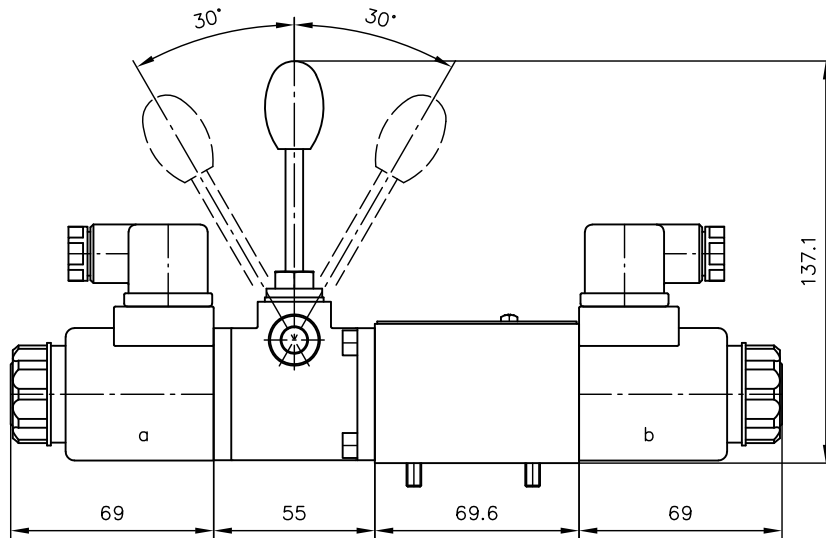

Circuit symbol **G, D, H, L, X, C, E, O** with HB actuation

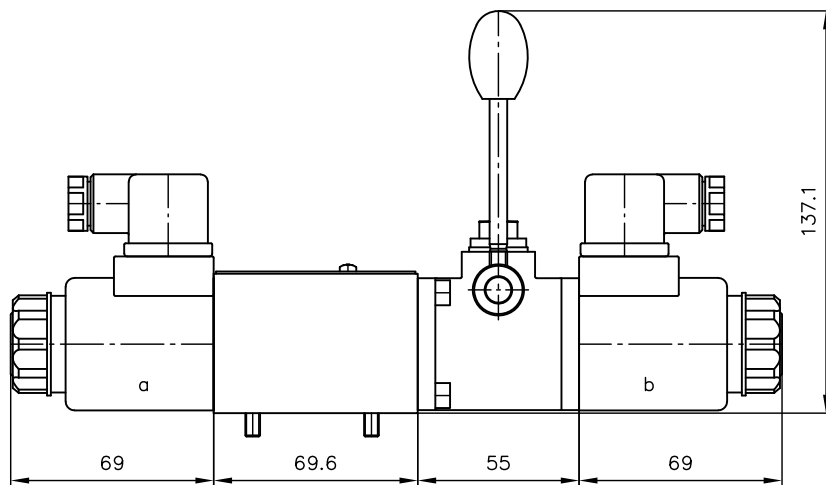

4/2-way directional valve

Circuit symbol **GW, HW, B, R, V** with HA actuation

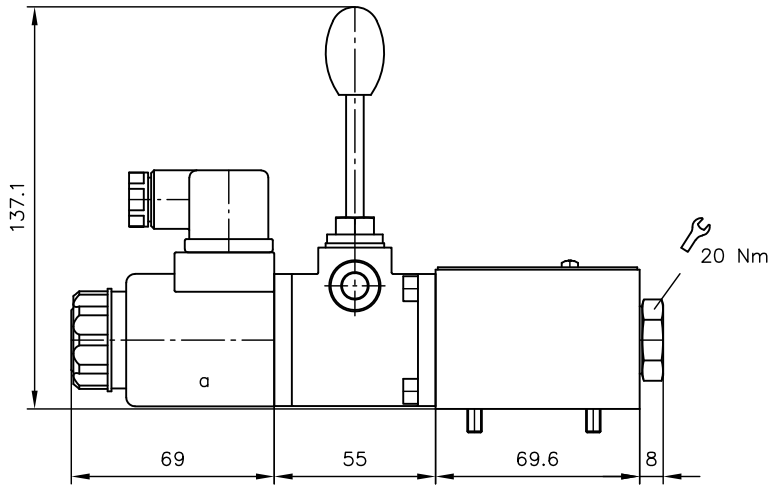

Circuit symbol **GB, HB, W** with HB actuation

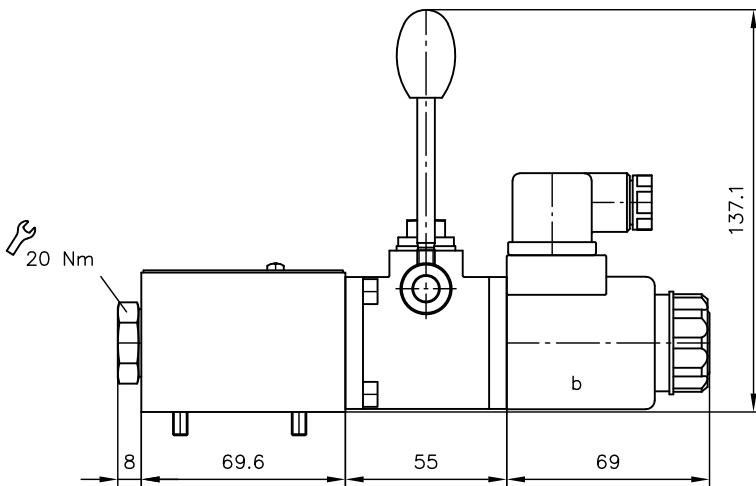

4.3 Hole pattern of the base plate

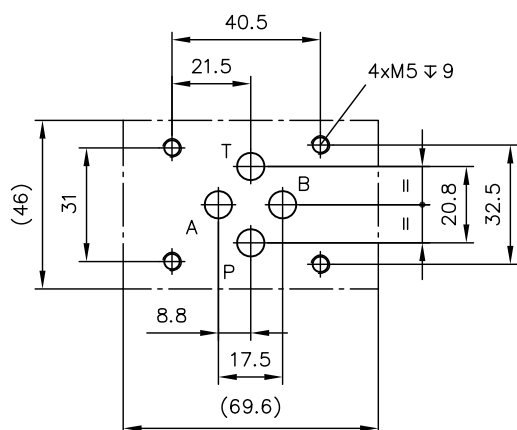

Ports to ISO 4401-03 or
DIN 24 340-A6

A, B, P, T $\leq \varnothing 7.5$

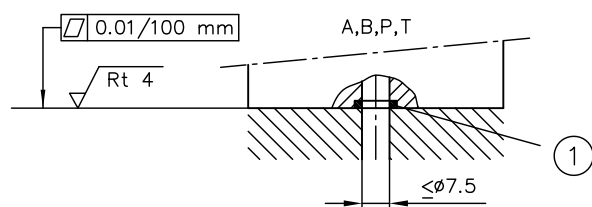

1 O-ring 9.25 x 1.78 NBR 90 Sh

Observe the document B 5488 "General operating instructions for assembly, commissioning, and maintenance."

5.1 Intended use

This product is intended exclusively for hydraulic applications (fluid technology).

The user must observe the safety measures and warnings in this document.

Essential requirements for the product to function correctly and safely:

- ▶ All information in this documentation must be observed. This applies in particular to all safety measures and warnings.
- ▶ The product must only be assembled and put into operation by specialist personnel.
- ▶ The product must only be operated within the specified technical parameters described in detail in this document.
- ▶ All components must be suitable for the operating conditions when using an assembly.
- ▶ The operating instructions for the components, assemblies and the specific complete system must also always be observed.

If the product can no longer be operated safely:

1. Remove the product from operation and mark it accordingly.
 - ✓ It is then not permitted to continue using or operating the product.

5.2 Assembly information

The product must only be installed in the complete system with standard and compliant connection components (screw fittings, hoses, pipes, fixtures etc.).

The product must be shut down correctly prior to disassembly (in particular in combination with hydraulic accumulators).



DANGER

Sudden movement of the hydraulic drives when disassembled incorrectly

Risk of serious injury or death

- ▶ Depressurise the hydraulic system.
- ▶ Perform safety measures in preparation for maintenance.

5.3 Operating instructions

Observe product configuration and pressure/flow rate.

The statements and technical parameters in this document must be strictly observed.

The instructions for the complete technical system must also always be followed.



DAMAGE

- ▶ Read the documentation carefully before usage.
- ▶ The documentation must be accessible to the operating and maintenance staff at all times.
- ▶ Keep documentation up to date after every addition or update.



CAUTION

Overloading components due to incorrect pressure settings.

Risk of minor injury.

- Pay attention to the maximum operating pressure of the pump and the valves.
- Always monitor the pressure gauge when setting and changing the pressure.

Purity and filtering of the hydraulic fluid

Fine contamination can significantly impair the function of the product. Contamination can cause irreparable damage.

Examples of fine contamination include:

- Swarf
- Rubber particles from hoses and seals
- Dirt due to assembly and maintenance
- Mechanical debris
- Chemical ageing of the hydraulic fluid

! DAMAGE

New hydraulic fluid from the manufacturer may not have the required purity.

Damage to the product is possible.

- ▶ Filter new hydraulic fluid to a high quality when filling.
- ▶ Do not mix hydraulic fluids. Always use hydraulic fluid that is from the same manufacturer, of the same type, and with the same viscosity properties.

For smooth operation, pay attention to the cleanliness level of the hydraulic fluid (cleanliness level [see Chapter 3, "Parameters"](#)).

Additionally applicable document: [D 5488/1](#) Oil recommendations

5.4 Maintenance information

Check regularly (at least once a year) by visual inspection whether the hydraulic connections are damaged. If external leakages are found, shut down and repair the system.

Clean the surface of the device regularly (at least once a year) (dust deposits and dirt).

6 Other information

6.1 Accessories, spare and individual parts

To purchase spare parts, please see [HAWE Hydraulik interactive contact map](#).

Line connectors

Version	Order coding	
Line connector (black)	MSD 3-309	6217 0002-00
Line connector (grey)	MSD 3-309 gr	6217 0003-00
Line connector with LED	SVS 3129020	6217 8024-00
Line connector with LED, 5 m cable	L5K	6217 8088-00
Line connector with LED, 10 m cable	L10K	6217 8090-00
Line connector with clamp diode	MSD 3-209 C1	6236 5002-00

Cylinder screws

M5x30-12.9 - DIN EN ISO 4762	6005 0485-00
------------------------------	--------------

Seals

Seals for P port, T port, A port and B port	O-ring 9.25 x 1.78 NBR 90 Sh	6096 9276-00
---	------------------------------	--------------

References

Additional versions

- Directional spool valve type NSWP 2: D 7451 N
- Directional seated valve type NBVP 16: D 7765 N
- Valve bank (nominal size 6) type BA: D 7788
- Valve bank type BNG: D 7788 BNG
- Clamping module type NSMD: D 7787
- Intermediate plate type NZP: D 7788 Z
- Directional spool valve banks type CWS: D 7951 CWS
- Directional spool valve type CWD: D 7951 CWD

